

SIMODRIVE 611

1FT7 Synchronous Motors

Configuration Manual · 03/2010

SIMODRIVE

SIEMENS

1FT7 synchronous motors

Configuration Manual

Preface

Description of the motors

1

Engineering

2

Mechanical properties of the motors

3

Technical data and characteristics

4

Motor components

5

Cables and connections

6

Information on the application of motors

7

Appendix

A

Legal information

Warning notice system

This manual contains notices you have to observe in order to ensure your personal safety, as well as to prevent damage to property. The notices referring to your personal safety are highlighted in the manual by a safety alert symbol, notices referring only to property damage have no safety alert symbol. These notices shown below are graded according to the degree of danger.

⚠ DANGER
indicates that death or severe personal injury will result if proper precautions are not taken.
⚠ WARNING
indicates that death or severe personal injury may result if proper precautions are not taken.
⚠ CAUTION
with a safety alert symbol, indicates that minor personal injury can result if proper precautions are not taken.
CAUTION
without a safety alert symbol, indicates that property damage can result if proper precautions are not taken.
NOTICE
indicates that an unintended result or situation can occur if the corresponding information is not taken into account.

If more than one degree of danger is present, the warning notice representing the highest degree of danger will be used. A notice warning of injury to persons with a safety alert symbol may also include a warning relating to property damage.

Qualified Personnel

The product/system described in this documentation may be operated only by **personnel qualified** for the specific task in accordance with the relevant documentation for the specific task, in particular its warning notices and safety instructions. Qualified personnel are those who, based on their training and experience, are capable of identifying risks and avoiding potential hazards when working with these products/systems.

Proper use of Siemens products

Note the following:

⚠ WARNING
Siemens products may only be used for the applications described in the catalog and in the relevant technical documentation. If products and components from other manufacturers are used, these must be recommended or approved by Siemens. Proper transport, storage, installation, assembly, commissioning, operation and maintenance are required to ensure that the products operate safely and without any problems. The permissible ambient conditions must be adhered to. The information in the relevant documentation must be observed.

Trademarks

All names identified by ® are registered trademarks of the Siemens AG. The remaining trademarks in this publication may be trademarks whose use by third parties for their own purposes could violate the rights of the owner.

Disclaimer of Liability

We have reviewed the contents of this publication to ensure consistency with the hardware and software described. Since variance cannot be precluded entirely, we cannot guarantee full consistency. However, the information in this publication is reviewed regularly and any necessary corrections are included in subsequent editions.

Preface

Information on the documentation

At <http://www.siemens.com/motioncontrol/docu> information is available on the following topics:

- Ordering documentation
Here you can find an up-to-date overview of publications
- Downloading documentation
Links to more information for downloading files from Service & Support.
- Researching documentation online
Information on DOConCD and direct access to the publications in DOConWeb.
- Compiling documentation individually on the basis of Siemens content with the My Documentation Manager (MDM), see <http://www.siemens.com/mdm>
The My Documentation Manager offers you a range of features for creating your own machine documentation.
- Training and FAQs
Information on the range of training courses and FAQs (frequently asked questions) are available via the page navigation.

Target group

Planners and project engineers

Benefits

The Configuration Manual supports you when selecting motors, calculating the drive components, selecting the required accessories as well as when selecting line and motor-side power options.

Standard scope

The scope of the functionality described in this document can differ from the scope of the functionality of the drive system that is actually supplied. Other functions not described in this documentation might be able to be executed in the drive system. This does not, however, represent an obligation to supply such functions with a new control or when servicing. Extensions or changes made by the machine manufacturer are documented by the machine manufacturer.

For the sake of simplicity, this documentation does not contain all detailed information about all types of the product and cannot cover every conceivable case of installation, operation, or maintenance.

Questions about this documentation

Please send any questions about the technical documentation (e.g. suggestions, corrections) to the following fax number or E-Mail address:

Fax	+49 (0) 9131 / 98-2176
E-mail	E-mail to: docu.motioncontrol@siemens.com

A fax form is available in the appendix of this document.

Internet address for products

<http://www.siemens.com/motioncontrol>

EC Declarations of Conformity

The EC Declaration of Conformity for the EMC Directive can be found/obtained

- in the Internet:
<http://support.automation.siemens.com> under entry ID 24520672 or
- with the responsible local Siemens office

Danger and warning information

 **DANGER**

Start-up/commissioning is absolutely prohibited until it has been completely ensured that the machine, in which the components described here are to be installed, is in full compliance with the provisions of the EC Machinery Directive.

Only appropriately qualified personnel may commission/start-up the SIMODRIVE units and the motors.

This personnel must carefully observe the technical customer documentation associated with this product and be knowledgeable about and carefully observe the danger and warnings.

Operational electrical equipment and motors have parts and components which are at hazardous voltage levels. All of the work carried-out on the electrical machine or system must be carried-out with it in a no-voltage condition.

When the machine or system is operated, hazardous axis movements can occur.

SIMODRIVE drive units with synchronous motors can only be connected to the line supply via residual current protective devices (RCD) if it has been verified (in accordance with EN 50178, Chapter 5.2.11.2) that the drive unit is compatible with such devices.

SIMODRIVE drive units are generally designed for operation on low-ohm, grounded line supplies (TN line supplies). For additional information, see the appropriate documentation for the converter systems.

⚠ WARNING

The successful and safe operation of this equipment and motors is dependent on professional transport, storage, installation and mounting as well as careful operator control, service and maintenance.

For special versions of the drive units and motors, information and data in the catalogs and quotations additionally apply.

In addition to the danger and warning information/instructions in the technical customer documentation supplied, the applicable domestic, local and plant-specific regulations and requirements must be carefully taken into account.

⚠ CAUTION

The motors can have surface temperatures of over +80 °C.

This is why temperature-sensitive components, e.g. cables or electronic components must not be in contact with or attached to the motor.

When connecting-up cables, please observe that they

- are not damaged
- are not subject to tensile stress
- cannot be touched by rotating components.

CAUTION

Motors should be connected up according to the operating instructions. They must not be connected directly to the three-phase supply because this will damage them.

SIMODRIVE units and motors are subject to a voltage test as part of a routine test. It is not permissible to perform an additional high-voltage test on the motor; such a test can destroy electronic components such as the temperature sensor or encoder.

Note

In operational condition and in dry operating areas, SIMODRIVE units with motors conform to the Low-Voltage Directive.

In the configurations specified in the associated EC Declaration of Conformity, SIMODRIVE units with motors conform to the EMC Directive.

ESDS instructions and electromagnetic fields

CAUTION

An electrostatic-sensitive device (ESDS) is an individual component, integrated circuit, or module that can be damaged by electrostatic fields or discharges.

ESDS regulations for handling boards and equipment:

When handling components that can be destroyed by electrostatic discharge, it must be ensured that personnel, the workstation and packaging are well grounded!

Personnel in ESD zones with conductive floors may only touch electronic components if they are

- grounded through an ESDS bracelet and
- wearing ESDS shoes or ESDS shoe grounding strips.

Electronic boards may only be touched when absolutely necessary.

Electronic boards may not be brought into contact with plastics and articles of clothing manufactured from man-made fibers.

Electronic boards may only be placed on conductive surfaces (table with ESDS surface, conductive ESDS foam rubber, ESDS packing bag, ESDS transport containers).

Electronic boards may not be brought close to data terminals, monitors or television sets. Minimum clearance to screens > 10 cm).

Measurements may only be carried-out on electronic boards and modules if

- the measuring instrument is grounded (e.g. via a protective conductor) or
- before making measurements with a potential-free measuring device, the measuring head is briefly discharged (e.g. by touching an unpainted blank piece of metal on the control cabinet).

DANGER

It may be dangerous for people to remain in the immediate proximity of the product – especially for those with pacemakers, implants or similar – due to electric, magnetic and electromagnetic fields (EMF) occurring as a consequence of operation.

The machine/system operator and the people present near the product must observe the relevant guidelines and standards! These are, for example, in the European Economic Area (EEA) the Electromagnetic Fields Directive 2004/40/EC and the standards EN 12198-1 to 12198-3 and in the Federal Republic of Germany the Employer's Liability Insurance Association Regulations for the Prevention of Industrial Accidents BGV 11, with the relevant rule BGR 11 "Electromagnetic Fields".

Then a risk assessment must be carried out for every workplace, activities for reducing dangers and exposure for people decided upon and implemented, as well as determining and observing exposure and danger areas.

Information regarding third-party products

NOTICE

This document contains recommendations relating to third-party products. This involves third-party products whose fundamental suitability is familiar to us. It goes without saying that equivalent products from other manufacturers may be used. Our recommendations are to be seen as helpful information, not as requirements or regulations. We cannot accept any liability for the quality and properties/features of third-party products.

Environmental compatibility

- Environmental aspects during development

When selecting supplier parts, environmental compatibility was an essential criteria. Special emphasis was placed on reducing the envelope dimensions, mass and type variety of metal and plastic parts.

Effects of paint-wetting impairment substances can be excluded (PWIS test)
- Environmental aspects during production

Supplier parts and the products are predominantly transported in re-usable packing. Transport for hazardous materials is not required.

The packing materials themselves essentially comprises paperboard containers that are in compliance with the Packaging Directive 94/62/EC.

Energy consumption during production was optimized.

Production has low emission levels.
- Environmental aspects for disposal

Motors must be disposed of carefully taking into account domestic and local regulations in the normal recycling process or by returning to the manufacturer.

The following must be taken into account when disposing of the motor:

Oil according to the regulations for disposing of old oil (e.g. gear oil when a gearbox is mounted)

Not mixed with solvents, cold cleaning agents or remains of paint

Components that are to be recycled should be separated according to:

 - Electronics scrap (e.g. encoder electronics, sensor modules)
 - Iron to be recycled
 - Aluminum
 - Non-ferrous metal (gearwheels, motor windings)

Residual risks of power drive systems

When carrying out a risk assessment of the machine in accordance with the EU Machinery Directive, the machine manufacturer must consider the following residual risks associated with the control and drive components of a power drive system (PDS).

1. Unintentional movements of driven machine components during commissioning, operation, maintenance, and repairs caused by, for example:
 - Hardware defects and/or software errors in the sensors, controllers, actuators, and connection technology
 - Response times of the controller and drive
 - Operating and/or ambient conditions not within the scope of the specification
 - Parameterization, programming, cabling, and installation errors
 - Use of radio devices / cellular phones in the immediate vicinity of the controller
 - External influences / damage
2. Exceptional temperatures as well as emissions of light, noise, particles, or gas caused by, for example:
 - Component malfunctions
 - Software errors
 - Operating and/or ambient conditions not within the scope of the specification
 - External influences / damage
3. Hazardous shock voltages caused by, for example:
 - Component malfunctions
 - Influence of electrostatic charging
 - Induction of voltages in moving motors
 - Operating and/or ambient conditions not within the scope of the specification
 - Condensation / conductive contamination
 - External influences / damage
4. Electrical, magnetic and electromagnetic fields generated in operation that can pose a risk to people with a pacemaker, implants or metal replacement joints, etc. if they are too close.
5. Release of environmental pollutants or emissions as a result of improper operation of the system and/or failure to dispose of components safely and correctly.

More extensive information concerning the residual risks associated with the PDS is provided in the relevant chapters of the technical user documentation.

Table of contents

	Preface	5
1	Description of the motors	15
1.1	Properties	15
1.2	Torque overview	17
1.3	Technical features.....	19
1.4	Rating plate	20
1.5	Selection and ordering data	21
1.6	Motor overview/power unit assignment	35
2	Engineering	39
2.1	SinuCom commissioning tool.....	39
2.2	NCS D Configurator	39
2.3	Procedure when engineering	41
2.3.1	Clarification of the type of drive.....	42
2.3.2	Defining the supplementary conditions and integration into an automation system.....	42
2.3.3	Definition of the load, calculation of max. load torque and definition of the motor	43
3	Mechanical properties of the motors	49
3.1	Cooling	49
3.1.1	Natural cooling	49
3.1.2	Forced ventilation.....	49
3.1.3	Water cooling	50
3.1.3.1	Cooling circuit.....	51
3.1.3.2	Engineering the cooling circuit.....	54
3.1.3.3	Coolant.....	57
3.1.3.4	Coolant connection	60
3.1.3.5	Commissioning.....	60
3.2	Flange forms	61
3.3	Degree of protection	62
3.4	Bearing version	63
3.5	Radial and axial forces.....	64
3.5.1	Calculating the belt pre-tension	64
3.5.2	Radial force loading	64
3.5.3	Axial force stressing	67
3.6	Smooth running, concentricity and axial eccentricity	68
3.7	Shaft end.....	69
3.8	Balancing	69
3.9	Vibration severity grade	70
3.10	Noise emission.....	71

3.11	Paint finish.....	71
4	Technical data and characteristics.....	73
4.1	Operating range and characteristics.....	73
4.2	Torque-speed characteristic.....	84
4.2.1	1FT7 synchronous motors, naturally cooled.....	84
4.2.2	1FT7 synchronous motors with forced ventilation.....	150
4.2.3	1FT7 synchronous motors, water cooling.....	166
4.2.4	1FT7 High Dynamic synchronous motors, forced ventilation.....	216
4.2.5	1FT7 High Dynamic synchronous motors, liquid cooling.....	232
4.3	Dimension drawings.....	248
5	Motor components.....	261
5.1	Thermal motor protection.....	261
5.2	Encoders.....	263
5.2.1	Encoder overview.....	263
5.2.2	Incremental encoders.....	263
5.2.3	Absolute encoder.....	265
5.3	Holding brake (option).....	266
5.3.1	Properties.....	266
5.3.2	Permanent-magnet brake.....	266
5.3.3	Connection of the holding brake to an external power supply via a contactor.....	267
5.3.4	Technical data of the holding brake.....	268
5.4	Gearboxes.....	270
5.4.1	Dimensioning the gearbox.....	270
5.4.2	Motors with planetary gearbox.....	272
5.5	Braking resistors (armature short-circuit braking).....	278
6	Cables and connections.....	285
6.1	Power connection.....	285
6.2	Signal connection.....	289
6.3	Connecting the separately-driven fan.....	290
6.4	Quick-release lock.....	291
6.5	Rotating the connector at the motor.....	291
6.6	Routing cables in a wet/moist environment.....	292
7	Information on the application of motors.....	295
7.1	Transport / storage before use.....	295
7.2	Environmental conditions.....	295
7.3	Construction types.....	296
7.4	Mounting conditions.....	296
7.5	Operation under vibrational or shock stress conditions.....	297
7.6	Drive coupling.....	298
7.7	Permissible line system configurations.....	298
A	Appendix.....	299

A.1	Description of terms	299
A.2	References	303
A.3	Suggestions/corrections	304
A.4	Siemens Service Center	305
Index		307

Description of the motors

1.1 Properties

Overview

The 1FT7 synchronous motors are permanent-magnet synchronous motors with very compact dimensions. Quick, easy mounting of the motors is possible due to the well proven cross-profile.

The 1FT7 motors satisfy the highest demands in terms of dynamic response, speed setting range including field weakening, radial eccentricity and positioning accuracy. They are equipped with state-of-the-art encoder technology and are optimized for operation on our completely digitally designed drive and control systems.

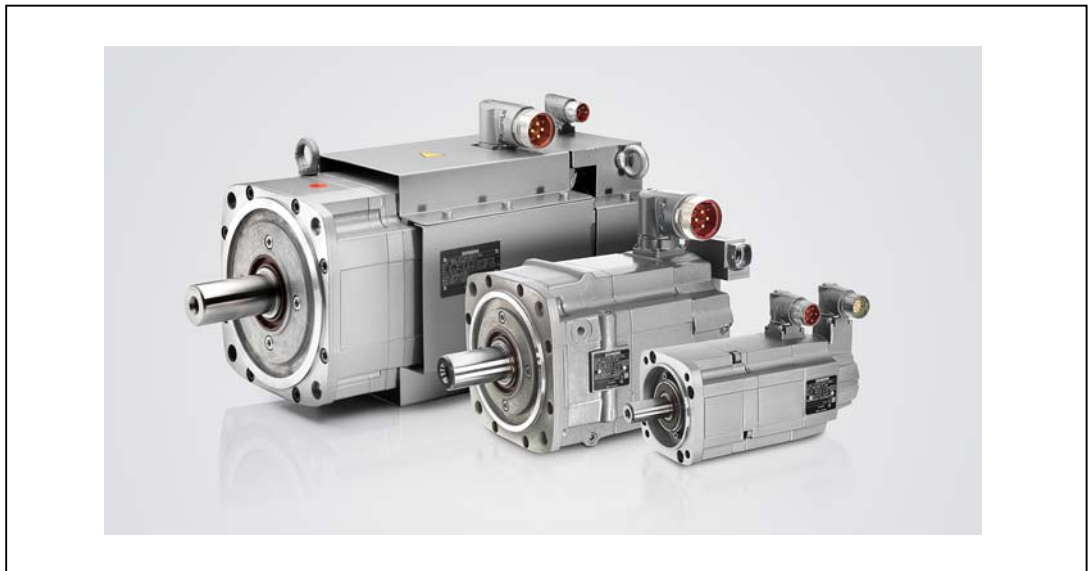

Figure 1-1 1FT7 synchronous motors

Natural cooling, forced ventilation or water cooling can be selected as cooling types. With natural cooling, heat is dissipated through the surface of the motor to the ambient air, whereas with forced ventilation, a mounted fan produces a continuous airflow that dissipates the heat loss. Maximum cooling and therefore maximum power ratings can be achieved by using water cooling.

Benefits

1FT7 motors offer:

- High concentricity quality and low torque ripple for best possible surface finish on the workpiece
- Short non-productive times due to high dynamic performance
- High overload capability ($4 \cdot M_0$ naturally-cooled)
- Compact design
- High degree of protection
- Sturdy, vibration-isolated encoder mounting
- Easy encoder replacement on site without alignment
- Quick and easy mounting due to cross-profile
- Rotatable connectors with quick-release lock
- New flange design with set-back flange surface particularly suitable for toothed belt output and IM V3 type of construction (1FT6-compatible flange can be ordered as an option)
- Extremely high efficiency

Area of application

- High-performance machine tools
- Machines with stringent requirements in terms of dynamic response and precision, such as packaging machines, textile machines, foil extractor machines, printing presses and production machines.

1.2 Torque overview

1FT7 Compact

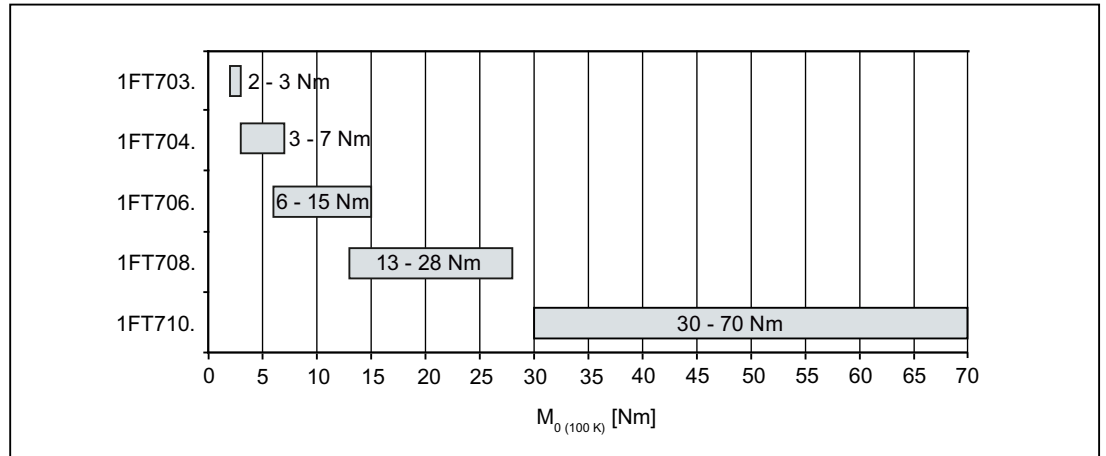

Figure 1-2 Static torque 1FT7 Compact, natural cooling

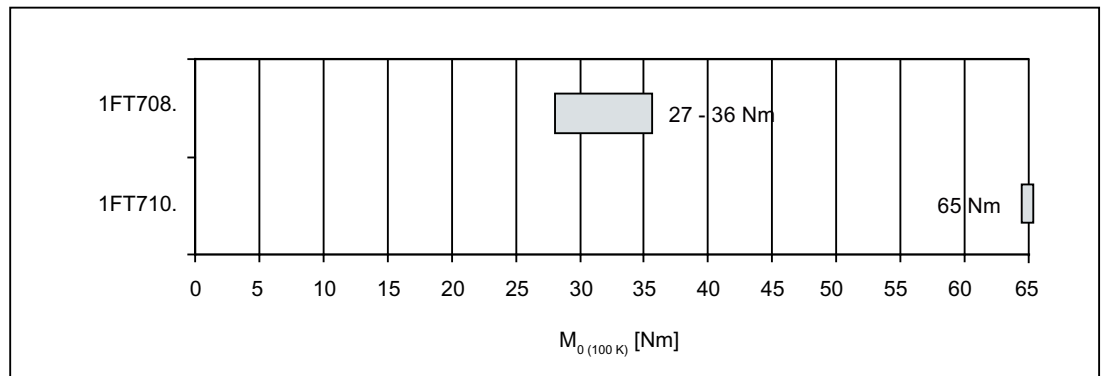

Figure 1-3 Static torque 1FT7 Compact, forced ventilation

1.2 Torque overview

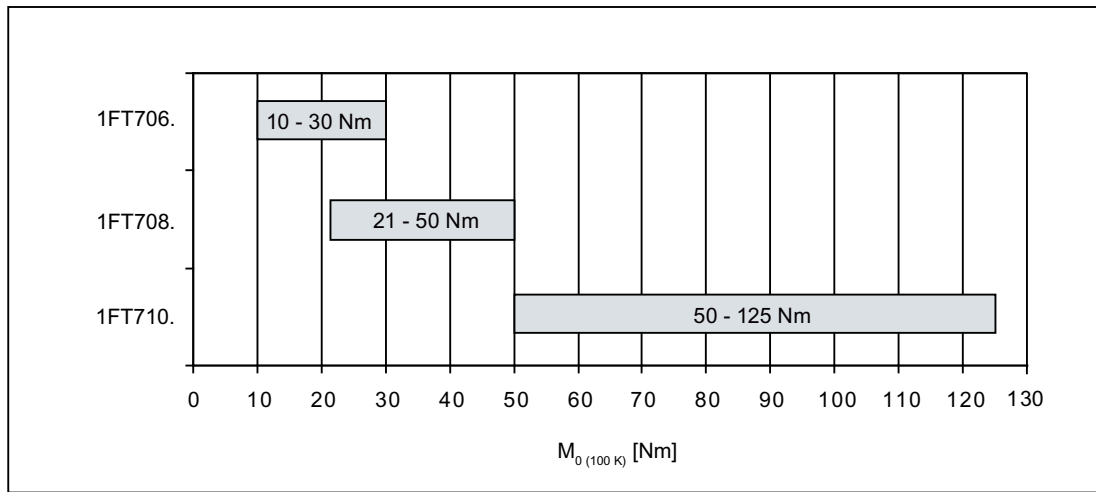

Figure 1-4 Static torque 1FT7 Compact, liquid cooling

1FT7 High Dynamic

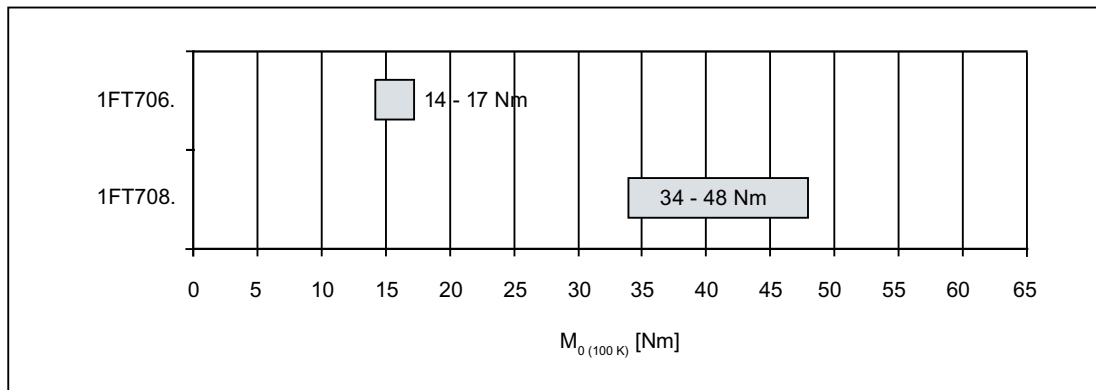

Figure 1-5 Static torque High Dynamic, forced ventilation

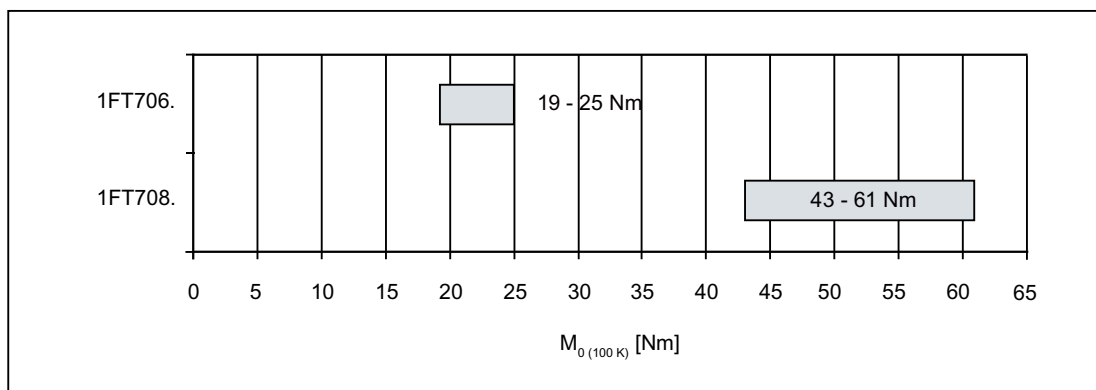

Figure 1-6 Static torque 1FT7 High Dynamic, liquid cooling

1.3 Technical features

Table 1- 1 Technical features

Motor type	Permanent-magnet synchronous motor
Magnet material	Rare-earth magnetic material
Insulation of the stator winding according to EN 60034-1 (IEC 60034-1)	Temperature class 155 (F) for a winding overtemperature of $\Delta T = 100$ K at an ambient temperature of $+40$ °C (naturally cooled, forced ventilation) or a coolant temperature of $+30$ °C (liquid-cooled)
Installation altitude according to EN 60034-1 (IEC 60034-1)	≤ 1000 m above sea level, otherwise power derating
Type of construction according to EN 60034-7 (IEC 60034-7)	IM B5 (IM V1, IM V3)
Degree of protection acc. to EN 60034-5 (IEC 60034-5)	IP65 (fan with forced ventilation IP54)
Cooling	Natural cooling, forced ventilation and water cooling
Temperature monitoring acc. to EN 60034-11 (IEC 60034-11)	KTY 84 temperature sensor in the stator winding
Paint finish	Pearl dark gray (similar to RAL 9023)
Drive shaft end acc. to DIN 748-3 (IEC 60072-1)	Plain shaft
Radial eccentricity, concentricity and axial eccentricity acc. to DIN 42955 (IEC 60072-1)	Tolerance N (normal)
Vibration magnitude according to EN 60034-14 (IEC 60034-14)	Grade A is observed up to rated speed
Sound pressure level acc. to DIN EN ISO 168 Tolerance + 3 dB(A)	Natural cooling: 1FT703□ to 1FT706□: 65 dB(A) 1FT708□ to 1FT710□: 70 dB(A) Forced ventilation: 73 dB(A) Water cooling: 1FT706□: 65 dB(A) 1FT708□ to 1FT710□: 70 dB(A)
Encoder system	<ul style="list-style-type: none"> Incremental encoder, sin/cos 1 Vpp, 2048 S/R ¹⁾ with C and D tracks (IC2048S/R encoder) Absolute encoder 2048 S/R ¹⁾ singleturn, 4096 revolutions multiturn, with EnDat interface (AM2048S/R encoder)
Connection	Connectors for signals and power
Options	<ul style="list-style-type: none"> Flange 1 (compatible with 1FT6) Drive shaft end with key and keyway (half-key balancing) Integrated holding brake Degree of protection IP64, IP67 Sealing air connection (only in conjunction with IP67) Vibration magnitude Grade R Radial eccentricity, concentricity and axial eccentricity: Tolerance R Motors with connector size 3 allow a terminal box version as an alternative

1) S/R = Signals/Revolution

1.4 Rating plate

The rating plate contains the technical data relevant to the motor. A 2nd rating plate is enclosed with the motor when it is supplied.

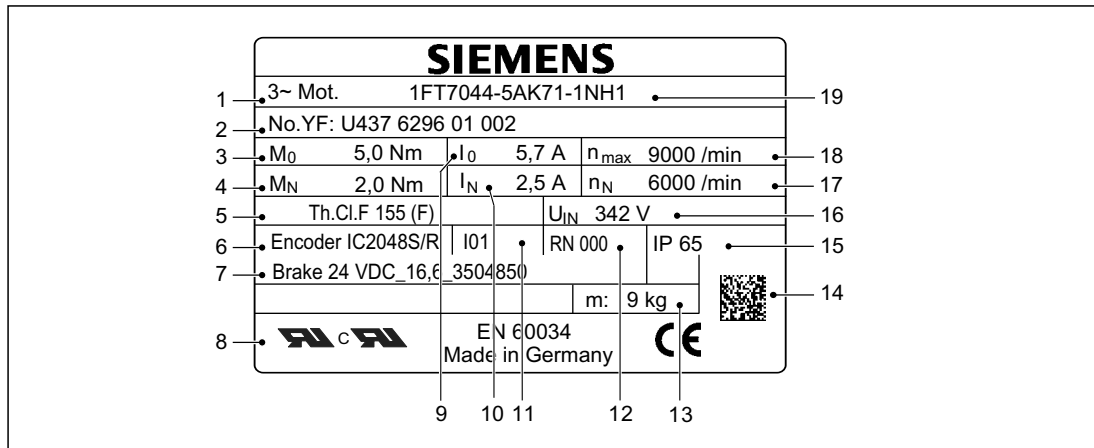

Figure 1-7 Schematic layout of rating plate

Table 1-2 Description of the rating plate data

Position	Description / Technical data
1	Motor type: Synchronous motors
2	ID no., serial number
3	Static torque M_0 (100 K) [Nm]
4	Rated torque M_N [Nm]
5	Temperature class
6	Code, encoder type
7	Holding brake data: Typical, voltage, power consumption
8	Standards and regulations
9	Stall current I_0 (100 K) [A]
10	Rated current I_N [A]
11	Encoder version
12	Motor version
13	Motor weight m [kg]
14	2D code
15	Degree of protection
16	Induced voltage at rated speed V_{IN} [V]
17	Rated speed n_N [rpm]
18	Maximum speed n_{max} [rpm]
19	SIEMENS motor type/order number

1.5 Selection and ordering data

1FT7 Compact natural cooling, core type

Rated speed	Shaft height	Rated power	Static torque	Rated torque	Rated current	1FT7 Compact synchronous motors Natural cooling	Number of pole pairs	Rotor moment of inertia (without brake)	Weight (without brake)
n_{rated}	SH	P_{rated} at $\Delta T=100\text{ K}$	M_0 at $\Delta T=100\text{ K}$	M_{rated} at $\Delta T=100\text{ K}$	I_{rated} at $\Delta T=100\text{ K}$	Order No. Core type		J	m
rpm		kW (HP)	Nm (lb _f -in)	Nm (lb _f -in)	A			10 ⁻⁴ kgm ² (10 ⁻³ x lb _f -in-s ²)	kg (lb)
2000	100	5.03 (6.75)	30 (266)	24 (212)	10	1FT7102 - 1AC7 - 1 ■ ■ 1	5	91.4 (80.9)	26.1 (57.6)
		7.96 (10.7)	50 (443)	38 (336)	15	1FT7105 - 1AC7 - 1 ■ ■ 1	5	178 (158)	44.2 (97.5)
3000	48	1.35 (1.81)	5 (44.3)	4.3 (38.1)	2.6	1FT7044 - 1AF7 - 1 ■ ■ 1	3	5.43 (4.81)	7.2 (15.9)
	63	1.7 (2.28)	6 (53.1)	5.4 (47.8)	3.9	1FT7062 - 1AF7 - 1 ■ ■ 1	5	7.36 (6.51)	7.1 (15.7)
		2.39 (3.20)	9 (79.7)	7.6 (67.3)	5.1	1FT7064 - 1AF7 - 1 ■ ■ 1	5	11.9 (10.5)	9.7 (21.4)
	80	3.24 (4.34)	13 (115)	10.3 (91.2)	6.6	1FT7082 - 1AF7 - 1 ■ ■ 1	5	26.5 (23.5)	14 (30.9)
		4.55 (6.10)	20 (177)	14.5 (128)	8.5	1FT7084 - 1AF7 - 1 ■ ■ 1	5	45.1 (39.9)	20.8 (45.9)
		5.65 (7.58)	28 (248)	18 (159)	11	1FT7086 - 1AF7 - 1 ■ ■ 1	5	63.6 (56.3)	27.5 (60.6)
4500	80	4.82 (6.46) ³⁾	20 (177)	11.5 (102) ³⁾	10.1 ³⁾	1FT7084 - 1AH7 - 1 ■ ■ 1	5	45.1 (39.9)	20.8 (45.9)
		4.71 (6.32)	28 (248)	10.0 (88.5)	10.0	1FT7086 - 1AH7 - 1 ■ ■ 1	5	63.6 (56.3)	27.5 (60.6)
6000	36	0.88 (1.18)	2 (17.7)	1.4 (12.4)	2.1	1FT7034 - 1AK7 - 1 ■ ■ 1	3	0.85 (0.75)	3.8 (8.38)
	63	2.13 (2.86) ¹⁾	6 (53.1)	3.7 (32.7) ¹⁾	5.9 ¹⁾	1FT7062 - 1AK7 - 1 ■ ■ 1	5	7.36 (6.51)	7.1 (15.7)
		2.59 (3.47) ²⁾	9 (79.7)	5.5 (48.7) ²⁾	6.1 ²⁾	1FT7064 - 1AK7 - 1 ■ ■ 1	5	11.9 (10.5)	9.7 (21.4)

Type IM B5:	Flange 0 Flange 1 (compatible with 1FT6)	0 1	
Encoder systems:	Incremental encoder sin/cos 1 V _{DD} 2048 S/R Absolute encoder EnDat 2048 S/R	N M	
Shaft extension: Plain shaft Plain shaft	Shaft and flange accuracy: Tolerance N	Holding brake: without with	G H
Vibration magnitude: Grade A	Degree of protection: IP65		1

- ¹⁾ These values refer to $n = 5500$ rpm.
²⁾ These values refer to $n = 4500$ rpm.
³⁾ These values refer to $n = 4000$ rpm.

1FT7 Compact natural cooling, core type

Description of the motors

1.5 Selection and ordering data

Motor type (continued)	Static current I_0 at M_0 $\Delta T=100$ K A	Calculated power P_{calc} ⁶⁾ P_{calc} for M_0 $\Delta T=100$ K kW (HP)	Rated output current ⁵⁾ I_{rated} A	Order No. Power Unit see at chapter „motor over- view / power module assignment“	Power cable with complete shield Motor connection (and brake connection) via power connector		
					Power connector	Cable cross- section ⁴⁾	Order No. Pre-assembled cable
					Size	mm ²	
1FT7102-1AC7...	12	6.28 (8.42)	18		1.5	4 x 1.5	6FX 002 - 5 Q21 -
1FT7105-1AC7...	18	10.47 (14.0)	18		1.5	4 x 2.5	6FX 002 - 5 Q31 -
1FT7044-1AF7...	2.8	1.57 (2.11)	3		1	4 x 1.5	6FX 002 - 5 Q01 -
1FT7062-1AF7...	3.9	1.88 (2.52)	5		1	4 x 1.5	6FX 002 - 5 Q01 -
1FT7064-1AF7...	5.6	2.83 (3.80)	9		1	4 x 1.5	6FX 002 - 5 Q01 -
1FT7082-1AF7...	7.6	4.08 (5.47)	9		1	4 x 1.5	6FX 002 - 5 Q01 -
1FT7084-1AF7...	11	6.28 (8.42)	18		1	4 x 1.5	6FX 002 - 5 Q01 -
1FT7086-1AF7...	15.5	8.8 (11.8)	18		1.5	4 x 2.5	6FX 002 - 5 Q31 -
1FT7084-1AH7...	15.6	9.42 (12.6)	18		1.5	4 x 2.5	6FX 002 - 5 Q31 -
1FT7086-1AH7...	22.4	13.19 (17.6)	26		1.5	4 x 4	6FX 002 - 5 Q41 -
1FT7034-1AK7...	2.7	1.26 (1.69)	3		1	4 x 1.5	6FX 002 - 5 Q01 -
1FT7062-1AK7...	8.4	3.77 (5.06)	9		1	4 x 1.5	6FX 002 - 5 Q01 -
1FT7064-1AK7...	9	5.65 (7.58)	9		1	4 x 1.5	6FX 002 - 5 Q01 -

Type of power cable:

MOTION-CONNECT 800
MOTION-CONNECT 500

8
5

Without brake cores
With brake cores

C
D

For length code as well as power and signal cables, see Connection system MOTION-CONNECT.

....

⁴⁾ The current carrying capacity of the power cables complies with IEC 60204-1 for installation type C under continuous operating conditions at an ambient air temperature of 40 °C (104 °F), designed for I_0 (100 K), PVC/PUR-insulated cable.

⁵⁾ With default setting of the pulse frequency.

⁶⁾ $P_{calc} [kW] = \frac{M_0 [Nm] \times n_{rated}}{9550}$ $P_{calc} [HP] = \frac{M_0 [lb_f-in] \times n_{rated}}{63000}$

1FT7 Compact natural cooling, standard type

Rated speed	Shaft height	Rated power	Static torque	Rated torque	Rated current	1FT7 Compact synchronous motors Standard type Order No.	Number of pole pairs	Moment of inertia of rotor (without brake) J	Weight (without brake) m
n_{rated}	SH	P_{rated} at $\Delta T=100\text{ K}$	M_0 at $\Delta T=100\text{ K}$	M_{rated} at $\Delta T=100\text{ K}$	I_{rated} at $\Delta T=100\text{ K}$				
rpm		kW (HP)	Nm (lb _f -ft)	Nm (lb _f -ft)	A				
Natural cooling									
1500	100	4.08 (5.47)	30 (22.1)	26 (19.2)	8	1FT7102-5AB7-1	5	91.4 (80.9)	26.1 (57.5)
		6.60 (8.85)	50 (36.9)	42 (31.0)	13	1FT7105-5AB7-1	5	178 (157)	44.2 (97.5)
		9.58 (12.8)	70 (51.6)	61 (45.0)	16	1FT7108-5AB7-1	5	248 (219)	59.0 (130)
2000	80	2.39 (3.20)	13 (9.6)	11.4 (8.4)	4.9	1FT7082-5AC7-1	5	26.5 (23.5)	14 (30.9)
		3.54 (4.75)	20 (14.8)	16.9 (12.5)	8.4	1FT7084-5AC7-1	5	45.1 (39.9)	20.8 (45.9)
		4.71 (6.32)	28 (20.7)	22.5 (16.6)	9.2	1FT7086-5AC7-1	5	63.6 (56.3)	27.5 (60.6)
	100	5.03 (6.75)	30 (22.1)	24.0 (17.7)	10	1FT7102-5AC7-1	5	91.4 (80.9)	26.1 (57.5)
		7.96 (10.7)	50 (36.9)	38.0 (28.0)	15	1FT7105-5AC7-1	5	178 (157)	44.2 (97.5)
		10.47 (14.0)	70 (51.6)	50.0 (36.9)	18	1FT7108-5AC7-1	5	248 (219)	59 (130)
3000	48	0.85 (1.14)	3.0 (2.2)	2.7 (2.0)	2.1	1FT7042-5AF7-1	3	2.81 (2.49)	4.6 (10.1)
		1.35 (1.81)	5.0 (3.7)	4.3 (3.2)	2.6	1FT7044-5AF7-1	3	5.43 (4.81)	7.2 (15.9)
		1.76 (2.36)	7.0 (5.2)	5.6 (4.1)	3.5	1FT7046-5AF7-1	3	7.52 (6.66)	9.3 (20.5)
	63	1.70 (2.28)	6.0 (4.4)	5.4 (4.0)	3.9	1FT7062-5AF7-1	5	7.36 (6.51)	7.1 (15.7)
		2.39 (3.20)	9.0 (6.6)	7.6 (5.6)	5.2	1FT7064-5AF7-1	5	11.9 (10.5)	9.7 (21.4)
		2.92 (3.92)	12.0 (8.9)	9.3 (6.9)	7.2	1FT7066-5AF7-1	5	16.4 (14.5)	12.3 (27.1)
		3.42 (4.59)	15.0 (11.1)	10.9 (8.0)	6.7	1FT7068-5AF7-1	5	23.2 (20.5)	16.3 (35.9)
	80	3.24 (4.34)	13.0 (9.6)	10.3 (7.6)	6.6	1FT7082-5AF7-1	5	26.5 (23.5)	14.0 (30.9)
		4.55 (6.10)	20.0 (14.8)	14.5 (10.7)	8.5	1FT7084-5AF7-1	5	45.1 (39.9)	20.8 (45.9)
		5.65 (7.58)	28.0 (20.7)	18 (13.3)	11	1FT7086-5AF7-1	5	63.6 (56.3)	27.5 (60.6)
	100	6.28 (8.42)	30.0 (22.1)	20 (14.8)	12	1FT7102-5AF7-1	5	91.4 (80.9)	26.1 (57.5)
		8.80 (11.8)	50.0 (36.9)	28 (20.7)	15	1FT7105-5AF7-1	5	178 (157)	44.2 (97.5)
6.28 (8.42)		70.0 (51.6)	20 (14.8)	12	1FT7108-5AF7-1	5	248 (220)	59.0 (130)	
Type of construction IM B5:			IM B5	Flange 0 Flange 1 (compatible with 1FT6)	0 1				
Encoder systems for motors without DRIVE-CLiQ interface:			Incremental encoder sin/cos 1 V _{pp} 2048 S/R with C and D tracks (encoder IC2048S/R)			N			
			Absolute encoder EnDat 2048 S/R (encoder AM2048S/R)			M			
Shaft extension:		Shaft and flange accuracy:		Holding brake:					
Fitted key and keyway		Tolerance N		Without					A
Fitted key and keyway		Tolerance N		With					B
Fitted key and keyway		Tolerance R		Without					D
Fitted key and keyway		Tolerance R		With					E
Plain shaft		Tolerance N		Without					G
Plain shaft		Tolerance N		With					H
Plain shaft		Tolerance R		Without					K
Plain shaft		Tolerance R		With					L
Vibration magnitude:			Degree of protection:						
Grade A			IP64						0
Grade A			IP65						1
Grade A			IP67						2
Grade R			IP64						3
Grade R			IP65						4
Grade R			IP67						5

1FT7 Compact natural cooling, standard type

1FT7 synchronous motors

Configuration Manual, (PFT7), 03/2010, 6SN1197-0AC13-0BP3

Description of the motors

1.5 Selection and ordering data

Motor type (repeated)	Efficiency ¹⁾ η %	Static current I ₀ at M ₀ ΔT=100 K A	Calculated power P _{calc} ⁴⁾ P _{calc} for M ₀ ΔT=100 K kW (HP)	Rated output current ²⁾ I _{rated} A	Order No. Power Unit see at chapter "motor overview / power module assignment"	Power cable with complete shield		
						Motor connection (and brake connection) via power connector		
						Power connector	Cable cross- section ³⁾	Pre-assembled cable
Size	mm ²	Order No.						
1FT7102-5AB7...	93	9	4.71 (6.32)	9		1.5	4 × 1.5	6FX002-5Q21-....
1FT7105-5AB7...	93	15	7.85 (10.5)	18		1.5	4 × 1.5	6FX002-5Q21-....
1FT7108-5AB7...	93	18	10.99 (14.7)	18		1.5	4 × 2.5	6FX002-5Q31-....
1FT7082-5AC7...	93	5	2.72 (3.65)	5		1	4 × 1.5	6FX002-5Q01-....
1FT7084-5AC7...	93	9	4.19 (5.62)	9		1	4 × 1.5	6FX002-5Q01-....
1FT7086-5AC7...	93	10.6	5.86 (7.86)	18		1	4 × 1.5	6FX002-5Q01-....
1FT7102-5AC7...	93	12.5	6.28 (8.42)	18		1.5	4 × 1.5	6FX002-5Q21-....
1FT7105-5AC7...	93	18	10.47 (14.0)	18		1.5	4 × 2.5	6FX002-5Q31-....
1FT7108-5AC7...	93	25	14.66 (19.7)	30		1.5	4 × 4	6FX002-5Q41-....
1FT7042-5AF7...	92	2.1	0.94 (1.26)	3		1	4 × 1.5	6FX002-5Q01-....
1FT7044-5AF7...	92	2.8	1.57 (2.11)	3		1	4 × 1.5	6FX002-5Q01-....
1FT7046-5AF7...	92	4	2.20 (2.95)	5		1	4 × 1.5	6FX002-5Q01-....
1FT7062-5AF7...	91	3.9	1.88 (2.52)	5		1	4 × 1.5	6FX002-5Q01-....
1FT7064-5AF7...	93	5.7	2.83 (3.80)	9		1	4 × 1.5	6FX002-5Q01-....
1FT7066-5AF7...	92	8.4	3.77 (5.06)	9		1	4 × 1.5	6FX002-5Q01-....
1FT7068-5AF7...	92	8.3	4.71 (6.32)	9		1	4 × 1.5	6FX002-5Q01-....
1FT7082-5AF7...	93	7.6	4.08 (5.47)	9		1	4 × 1.5	6FX002-5Q01-....
1FT7084-5AF7...	93	11	6.28 (8.42)	18		1	4 × 1.5	6FX002-5Q01-....
1FT7086-5AF7...	93	15.5	8.80 (11.8)	18		1.5	4 × 2.5	6FX002-5Q31-....
1FT7102-5AF7...	93	18	9.42 (12.6)	18		1.5	4 × 2.5	6FX002-5Q31-....
1FT7105-5AF7...	94	26	15.71 (21.0)	30		1.5	4 × 4	6FX002-5Q41-....
1FT7108-5AF7...	93	36	21.99 (29.5)	45		1.5	4 × 6	6FX002-5Q54-....

Power cable:		
MOTION-CONNECT 800	8	
MOTION-CONNECT 500	5	
Without brake cores		C
With brake cores		D
Length code	

Information about application, configuration and cable extensions can be found under Connection system MOTION-CONNECT.

1) Optimum efficiency in continuous duty.

2) With default setting of the pulse frequency.

3) The current carrying capacity of the power cables complies with EN 60204-1 for installation type C, for continuous duty at an ambient air temperature of 40 °C (104 °F).

4) $P_{\text{calc}} [\text{kW}] = \frac{M_0 [\text{Nm}] \times n_{\text{rated}}}{9550}$ $P_{\text{calc}} [\text{HP}] = \frac{M_0 [\text{lb}_f\text{-in}] \times n_{\text{rated}}}{63000}$

1FT7 Compact natural cooling, standard type

Rated speed	Shaft height	Rated power	Static torque	Rated torque	Rated current	1FT7 Compact synchronous motors Standard type	Number of pole pairs	Moment of inertia of rotor (without brake)	Weight (without brake)
n_{rated}	SH	P_{rated} at $\Delta T=100$ K	M_0 at $\Delta T=100$ K	M_{rated} at $\Delta T=100$ K	I_{rated} at $\Delta T=100$ K				
rpm		kW (HP)	Nm (lb _f -ft)	Nm (lb _f -ft)	A			10^{-4} kgm ² (10^{-3} lb _f -in-s ²)	kg (lb)
Natural cooling									
4500	48	1.32 (1.77) ¹⁾	7.0 (5.2)	3.6 (2.66) ¹⁾	4.7 ¹⁾	1FT7046-5AH7-1 ■ ■ ■ ■	3	7.52 (6.66)	9.3 (20.5)
	63	2.55 (3.42) ²⁾	12 (8.9)	6.1 (4.50) ²⁾	7.5 ²⁾	1FT7066-5AH7-1 ■ ■ ■ ■	5	16.4 (14.5)	12.3 (27.1)
	80	3.77 (5.06)	13 (9.6)	8.0 (5.9)	7.8	1FT7082-5AH7-1 ■ ■ ■ ■	5	26.5 (23.5)	14.0 (30.9)
		4.82 (6.46) ²⁾	20 (14.8)	11.5 (8.48) ²⁾	10.1 ²⁾	1FT7084-5AH7-1 ■ ■ ■ ■	5	45.1 (39.9)	20.8 (45.9)
		4.71 (6.32)	28 (20.7)	10 (7.4)	10	1FT7086-5AH7-1 ■ ■ ■ ■	5	63.6 (56.3)	27.5 (60.6)
6000	36	0.88 (1.18)	2.0 (1.5)	1.4 (1.0)	2.1	1FT7034-5AK7-1 ■ ■ ■ ■	3	0.85 (0.75)	3.8 (8.38)
		1.07 (1.43)	3.0 (2.2)	1.7 (1.3)	2.4	1FT7036-5AK7-1 ■ ■ ■ ■	3	1.33 (1.18)	5.0 (11.0)
	48	1.26 (1.69)	3.0 (2.2)	2.0 (1.5)	3	1FT7042-5AK7-1 ■ ■ ■ ■	3	2.81 (2.49)	4.6 (10.1)
		1.41 (1.89) ³⁾	5.0 (3.7)	3.0 (2.21) ³⁾	3.6 ³⁾	1FT7044-5AK7-1 ■ ■ ■ ■	3	5.43 (4.81)	7.2 (15.9)
	63	2.13 (2.86) ⁴⁾	6.0 (4.4)	3.7 (2.73) ⁴⁾	5.9 ⁴⁾	1FT7062-5AK7-1 ■ ■ ■ ■	5	7.36 (6.51)	7.1 (15.7)
		2.59 (3.47) ³⁾	9.0 (6.6)	5.5 (4.06) ³⁾	6.1 ³⁾	1FT7064-5AK7-1 ■ ■ ■ ■	5	11.9 (10.5)	9.7 (21.4)
Type of construction IM B5:			IM B5	Flange 0 Flange 1 (compatible with 1FT6)	0 1				
Encoder systems for motors without DRIVE-CLiQ interface:			Incremental encoder sin/cos 1 V _{pp} 2048 S/R with C and D tracks (encoder IC2048S/R)			N			
			Absolute encoder EnDat 2048 S/R (encoder AM2048S/R)			M			
Shaft extension:		Shaft and flange accuracy:		Holding brake:					
Fitted key and keyway		Tolerance N		Without					A
Fitted key and keyway		Tolerance N		With					B
Fitted key and keyway		Tolerance R		Without					D
Fitted key and keyway		Tolerance R		With					E
Plain shaft		Tolerance N		Without					G
Plain shaft		Tolerance N		With					H
Plain shaft		Tolerance R		Without					K
Plain shaft		Tolerance R		With					L
Vibration magnitude:		Degree of protection:							
Grade A		IP64							0
Grade A		IP65							1
Grade A		IP67							2
Grade R		IP64							3
Grade R		IP65							4
Grade R		IP67							5

1.5 Selection and ordering data

1FT7 Compact natural cooling, standard type

Motor type (repeated)	Efficiency ⁵⁾ η %	Static current I_0 at M_0 $\Delta T=100$ K A	Calculated power P_{calc} ⁸⁾ P_{calc} for M_0 $\Delta T=100$ K kW (HP)	Rated output current ⁶⁾ I_{rated} A	Order No. Power Unit see at chapter "motor overview / power module assignment"	Power cable with complete shield		
						Motor connection (and brake connection) via power connector		
						Power connector	Cable cross-section ⁷⁾ mm ²	Pre-assembled cable Order No.
1FT7046-5AH7...	90	8.1	3.30 (4.43)	9		1	4 × 1.5	6FX002-5Q01-....
1FT7066-5AH7...	90	13.6	5.65 (7.58)	18		1	4 × 1.5	6FX002-5Q01-....
1FT7082-5AH7...	93	12.3	6.13 (8.22)	18		1	4 × 1.5	6FX002-5Q01-....
1FT7084-5AH7...	93	15.6	9.42 (12.6)	18		1.5	4 × 2.5	6FX002-5Q31-....
1FT7086-5AH7...	91	22.4	13.19 (17.7)	30		1.5	4 × 4	6FX002-5Q41-....
1FT7034-5AK7...	90	2.7	1.26 (1.69)	3		1	4 × 1.5	6FX002-5Q01-....
1FT7036-5AK7...	90	4.0	1.88 (2.52)	5		1	4 × 1.5	6FX002-5Q01-....
1FT7042-5AK7...	91	3.9	1.88 (2.52)	5		1	4 × 1.5	6FX002-5Q01-....
1FT7044-5AK7...	91	5.7	3.14 (4.21)	9		1	4 × 1.5	6FX002-5Q01-....
1FT7062-5AK7...	90	8.4	3.77 (5.06)	9		1	4 × 1.5	6FX002-5Q01-....
1FT7064-5AK7...	91	9	5.65 (7.59)	9		1	4 × 1.5	6FX002-5Q01-....

Power cable:		
MOTION-CONNECT 800	8	
MOTION-CONNECT 500	5	
Without brake cores		C
With brake core		D
Length code	

Information about application, configuration and cable extensions can be found under Connection system MOTION-CONNECT.

- 1) These values refer to $n = 3500$ rpm.
- 2) These values refer to $n = 4000$ rpm.
- 3) These values refer to $n = 4500$ rpm.
- 4) These values refer to $n = 5500$ rpm.
- 5) Optimum efficiency in continuous duty.
- 6) With default setting of the pulse frequency.
- 7) The current carrying capacity of the power cables complies with EN 60204-1 for installation type C, for continuous duty at an ambient air temperature of 40 °C (104 °F).
- 8) $P_{calc} [kW] = \frac{M_0 [Nm] \times n_{rated}}{9550}$ $P_{calc} [HP] = \frac{M_0 [lb_f \cdot in] \times n_{rated}}{63000}$

1FT7 Compact forced ventilation, standard type

Rated speed	Shaft height	Rated power	Static torque	Rated torque	Rated current	1FT7 Compact synchronous motors Standard type	Number of pole pairs	Moment of inertia of rotor (without brake)	Weight (without brake)
n_{rated}	SH	P_{rated} at $\Delta T=100\text{ K}$	M_0 at $\Delta T=100\text{ K}$	M_{rated} at $\Delta T=100\text{ K}$	I_{rated} at $\Delta T=100\text{ K}$				
rpm		kW (HP)	Nm (lb _f -ft)	Nm (lb _f -ft)	A	Order No.		10^{-4} kgm^2 ($10^{-3}\text{ lb}_f\text{-in-s}^2$)	kg (lb)
Forced ventilation									
2000	80	5.0 (6.71)	27 (19.9)	24 (17.7)	13.5	1FT7084-5SC7 ■-1 ■ ■ ■ ■	5	45 (39.8)	25 (55.1)
		6.7 (8.98)	36 (26.6)	32 (23.6)	17	1FT7086-5SC7 ■-1 ■ ■ ■ ■	5	64 (56.6)	36 (79.4)
	100	11.7 (15.7)	65 (47.9)	56 (41.3)	29	1FT7105-5SC7 ■-1 ■ ■ ■ ■	5	178 (158)	50 (110)
3000	80	7.2 (9.66)	27 (19.9)	23 (17.0)	18.5	1FT7084-5SF7 ■-1 ■ ■ ■ ■	5	45 (39.8)	25 (55.1)
		9.1 (12.2)	36 (26.6)	29 (21.4)	24	1FT7086-5SF7 ■-1 ■ ■ ■ ■	5	64 (56.6)	36 (79.4)
	100	15.1 (20.2)	65 (47.9)	48 (35.4)	35	1FT7105-5SF7 ■-1 ■ ■ ■ ■	5	178 (158)	50 (110)
4500	80	9.9 (13.3)	27 (19.9)	21 (15.5)	24.5	1FT7084-5SH7 ■-1 ■ ■ ■ ■	5	45 (39.8)	25 (55.1)
		11.8 (15.8)	36 (26.6)	25 (18.4)	25	1FT7086-5SH7 ■-1 ■ ■ ■ ■	5	64 (56.6)	36 (79.4)
Type of construction IM B5:		IM B5	Flange 0 Flange 1 (compatible with 1FT6)			1			
Connector outlet direction:		Connector size 1 and 1.5	Connector can be rotated			1			
		Connector size 3 ¹⁾	Transverse right Transverse left Axial NDE Axial DE			1 2 3 4			
Terminal box/ cable entry:¹⁾		Top/transverse from right Top/transverse from left Top/axial from NDE Top/axial from DE					5 6 7 8		
Encoder systems for motors without DRIVE-CLiQ interface:		Incremental encoder sin/cos 1 V _{pp} 2048 S/R with C and D tracks (encoder IC2048S/R)						N	
		Absolute encoder EnDat 2048 S/R (encoder AM2048S/R)						M	
Shaft extension:		Shaft and flange accuracy:		Holding brake:				A B D E G H K L	
Fitted key		Tolerance N		Without					
Fitted key		Tolerance N		With					
Fitted key		Tolerance R		Without					
Fitted key		Tolerance R		With					
Plain shaft		Tolerance N		Without					
Plain shaft		Tolerance N		With					
Plain shaft		Tolerance R		Without					
Plain shaft		Tolerance R		With					
Vibration magnitude:		Degree of protection:						0 1 3 4	
Grade A		IP64							
Grade A		IP65							
Grade R		IP64							
Grade R		IP65							

1.5 Selection and ordering data

1FT7 Compact forced ventilation, standard type

Motor type (repeated)	Efficiency ²⁾ η %	Static current I_0 at M_0 $\Delta T=100$ K A	Calculated power P_{calc} ⁵⁾ P_{calc} for M_0 $\Delta T=100$ K kW (HP)	Rated output current ³⁾ I_{rated} A	Order No. Power Unit see at chapter "motor overview / power module assignment"	Power cable with complete shield		
						Motor connection (and brake connection) via power connector		
						Power connector	Cable cross-section ⁴⁾	Pre-assembled cable
						Size	mm ²	Order No.
1FT7084-5SC7...	93	15	5.7 (7.64)	18		1.5	4 × 1.5	6FX002-5Q21-....
1FT7086-5SC7...	93	19.5	7.5 (10.1)	30		1.5	4 × 2.5	6FX002-5Q31-....
1FT7105-5SC7...	93	31	13.6 (18.2)	45		1.5	4 × 6	6FX002-5Q54-....
1FT7084-5SF7...	94	21	8.5 (11.4)	30		1.5	4 × 2.5	6FX002-5Q31-....
1FT7086-5SF7...	93	29	11.3 (15.2)	30		1.5	4 × 6	6FX002-5Q51-....
1FT7105-5SF7...	94	45	20.4 (27.4)	45		3	4 × 10	6FX002-5A13-....
1FT7084-5SH7...	94	30.5	12.7 (17.0)	30		1.5	4 × 6	6FX002-5Q51-....
1FT7086-5SH7...	93	34	17.0 (22.8)	45		1.5	4 × 6	6FX002-5Q54-....

Power cable:		
MOTION-CONNECT 800	8	
MOTION-CONNECT 500	5	
Without brake cores		C
With brake core		D
Length code	

Information about application, configuration and cable extensions can be found under Connection system MOTION-CONNECT.

1) Connector size 3 cannot be rotated. Terminal box can be chosen alternatively only for connector size 3.

2) Optimum efficiency in continuous duty.

3) With default setting of the pulse frequency.

4) The current carrying capacity of the power cables complies with EN 60204-1 for installation type C, for continuous duty at an ambient air temperature of 40 °C (104 °F).

5) $P_{calc} [kW] = \frac{M_0 [Nm] \times n_{rated}}{9550}$ $P_{calc} [HP] = \frac{M_0 [lb_f-in] \times n_{rated}}{63000}$

1FT7 Compact liquid cooling, standard type

Rated speed	Shaft height	Rated power	Static torque	Rated torque	Rated current	1FT7 Compact synchronous motors Standard type Order No.	Number of pole pairs	Moment of inertia of rotor (without brake) J	Weight (without brake) m			
n_{rated}	SH	P_{rated} at $\Delta T=100\text{ K}$	M_0 at $\Delta T=100\text{ K}$	M_{rated} at $\Delta T=100\text{ K}$	I_{rated} at $\Delta T=100\text{ K}$							
rpm		kW (HP)	Nm (lb _f -ft)	Nm (lb _f -ft)	A						10^{-4} kgm^2 ($10^{-3}\text{ lb}_f\text{-in-s}^2$)	kg (lb)
Water cooling												
1500	100	7.9 (10.6)	50 (36.9)	50 (36.9)	20.3	1FT7102-5WB7-1 ■■■	5	98.9 (87.5)	36.6 (80.7)			
		14.1 (18.9)	90 (66.4)	90 (66.4)	29.5	1FT7105-5WB7-1 ■■■	5	191 (169)	54.8 (121)			
		19.6 (26.3)	125 (92.2)	125 (92.2)	40.3	1FT7108-5WB7-1 ■■■	5	265 (235)	68.6 (151)			
2000	80	4.4 (5.90)	21 (15.5)	21 (15.5)	11	1FT7082-5WC7-1 ■■■	5	28.9 (25.6)	20.7 (45.6)			
		7.33 (9.83)	35 (25.8)	35 (25.8)	17	1FT7084-5WC7-1 ■■■	5	48.3 (42.8)	27.5 (60.6)			
		10.5 (14.1)	50 (36.9)	50 (36.9)	24	1FT7086-5WC7-1 ■■■	5	67.8 (60.0)	34.1 (75.2)			
	100	10.4 (13.9)	50 (36.9)	49.5 (36.5)	29.3	1FT7102-5WC7-1 ■■■	5	98.9 (87.5)	36.6 (80.7)			
		18.8 (25.2)	90 (66.4)	90 (66.4)	40.8	1FT7105-5WC7-1 ■■■	5	191 (169)	54.8 (121)			
		26.2 (35.1)	125 (92.2)	125 (92.2)	47.5	1FT7108-5WC7-1 ■■■	5	265 (235)	69.6 (154)			
Type of construction IM B5:		IM B5	Flange 0 Flange 1 (compatible with 1FT6)	0 1								
Connector outlet direction:		Connector size 1 and 1.5	Connector can be rotated	1								
		Connector size 3 ¹⁾	Transverse right Transverse left Axial NDE Axial DE	1 2 3 4								
Terminal box/cable entry:¹⁾		Top/transverse from right Top/transverse from left Top/axial from NDE Top/axial from DE		5 6 7 8								
Encoder systems for motors without DRIVE-CLiQ interface:		Incremental encoder sin/cos 1 V _{pp} 2048 S/R with C and D tracks (encoder IC2048S/R)		N								
		Absolute encoder EnDat 2048 S/R (encoder AM2048S/R)		M								
Shaft extension:		Fitted key and keyway Fitted key and keyway Fitted key and keyway Fitted key and keyway Plain shaft Plain shaft Plain shaft Plain shaft	Shaft and flange accuracy: Tolerance N Tolerance N Tolerance R Tolerance R Tolerance N Tolerance N Tolerance R Tolerance R	Holding brake: Without With Without With Without With Without With					A B D E G H K L			
Vibration magnitude:		Grade A Grade A Grade A Grade R Grade R Grade R	Degree of protection: IP64 IP65 IP67 IP64 IP65 IP67	0 1 2 3 4 5								

1FT7 Compact liquid cooling, standard type

Motor type (repeated)	Efficiency ²⁾ η %	Static current I_0 at M_0 $\Delta T=100$ K A	Calculated power P_{calc} ⁵⁾ P_{calc} for M_0 $\Delta T=100$ K kW (HP)	Rated output current ³⁾ I_{rated} A	Order No. Power Unit see at chapter "motor overview / power module assignment"	Power cable with complete shield		
						Motor connection (and brake connection) via power connector	Power connector	Cable cross-section ⁴⁾ mm ²
1FT7102-5WB7...	93	17.8	7.9 (10.6)	18		1.5	4 × 2.5	6FX002-5Q31-....
1FT7105-5WB7...	94	28	14.1 (18.9)	30		1.5	4 × 4	6FX002-5Q41-....
1FT7108-5WB7...	94	39	19.6 (26.3)	45		1.5	4 × 10	6FX002-5Q64-....
1FT7082-5WC7...	93	10.7	4.4 (5.90)	18		1.5	4 × 1.5	6FX002-5Q21-....
1FT7084-5WC7...	94	16.5	7.3 (9.79)	18		1.5	4 × 2.5	6FX002-5Q31-....
1FT7086-5WC7...	94	23	10.5 (14.1)	30		1.5	4 × 4	6FX002-5Q41-....
1FT7102-5WC7...	94	25.5	10.5 (14.1)	30		1.5	4 × 4	6FX002-5Q41-....
1FT7105-5WC7...	94	39	18.8 (25.2)	45		1.5	4 × 10	6FX002-5Q64-....
1FT7108-5WC7...	95	45.3	26.2 (35.1)	45		3	4 × 10	6FX002-5A13-....

Power cable:		
MOTION-CONNECT 800	8	
MOTION-CONNECT 500	5	
Without brake cores		C
With brake cores		D
Length code	

Information about application, configuration and cable extensions can be found under Connection system MOTION-CONNECT.

1) Connector size 3 cannot be rotated. Terminal box can be chosen alternatively only for connector size 3.

2) Optimum efficiency in continuous duty.

3) With default setting of the pulse frequency.

4) The current carrying capacity of the power cables complies with EN 60204-1 for installation type C, for continuous duty at an ambient air temperature of 40 °C (104 °F).

5) $P_{calc} [kW] = \frac{M_0 [Nm] \times n_{rated}}{9550}$ $P_{calc} [HP] = \frac{M_0 [lb_f-in] \times n_{rated}}{63000}$

1FT7 Compact liquid cooling, standard type

Rated speed	Shaft height	Rated power	Static torque	Rated torque	Rated current	1FT7 Compact synchronous motors Standard type	Number of pole pairs	Moment of inertia of rotor (without brake) J	Weight (without brake) m			
n_{rated}	SH	P_{rated} at $\Delta T=100$ K	M_0 at $\Delta T=100$ K	M_{rated} at $\Delta T=100$ K	I_{rated} at $\Delta T=100$ K					Order No.	10^{-4} kgm ² (10^{-3} lb _f -in-s ²)	kg (lb)
rpm		kW (HP)	Nm (lb _f -ft)	Nm (lb _f -ft)	A							
Water cooling												
3000	63	3.1 (4.16)	10 (7.38)	10 (7.38)	7.8	1FT7062-5WF7-1 ■■■■	5	8.1 (7.17)	11 (24.3)			
		5 (6.71)	16 (11.8)	16 (11.8)	12.5	1FT7064-5WF7-1 ■■■■	5	12.9 (11.4)	13.7 (30.2)			
		6.2 (8.31)	20 (14.8)	19.6 (14.5)	14.4	1FT7066-5WF7-1 ■■■■	5	17.7 (15.7)	16.3 (35.9)			
		9.3 (12.5)	30 (22.1)	29.5 (21.8)	19.6	1FT7068-5WF7-1 ■■■■	5	24.8 (22.0)	20.1 (44.3)			
	80	6.28 (8.42)	21 (15.5)	20.5 (15.1)	16	1FT7082-5WF7-1 ■■■■	5	28.9 (25.6)	20.7 (45.6)			
		11 (14.8)	35 (25.8)	35 (25.8)	24.2	1FT7084-5WF7-1 ■■■■	5	48.3 (42.8)	27.5 (60.6)			
		15.4 (20.7)	50 (36.9)	49 (36.1)	36	1FT7086-5WF7-1 ■■■■	5	67.8 (60.0)	34.1 (75.2)			
	100	14.3 (19.2)	50 (36.9)	45.5 (33.6)	38.8	1FT7102-5WF7-1 ■■■■	5	98.9 (87.5)	36.6 (80.7)			
		24.8 (33.3)	90 (66.4)	79 (58.3)	49.5	1FT7105-5WF7-1 ■■■■	5	164 (145)	55.9 (123)			
		34.2 (45.9)	125 (92.2)	109 (80.4)	60	1FT7108-5WF7-1 ■■■■	5	265 (235)	69.6 (153)			
	4500	63	9.1 (12.2)	20 (14.8)	19.4 (14.0)	20.8	1FT7066-5WH7-1 ■■■■	5	17.7 (15.7)	16.3 (35.9)		
			8.95 (12.0)	21 (15.5)	19 (14.0)	23.9	1FT7082-5WH7-1 ■■■■	5	28.9 (25.6)	20.7 (45.6)		
14.6 (19.6)			35 (25.8)	32 (23.6)	34.5	1FT7084-5WH7-1 ■■■■	5	48.3 (42.8)	27.5 (60.6)			
80		20.3 (27.2)	50 (36.9)	43 (31.7)	38	1FT7086-5WH7-1 ■■■■	5	67.8 (60.0)	34.1 (75.2)			
		63	5.8 (7.78)	10 (7.38)	9.2 (6.79)	12.7	1FT7062-5WK7-1 ■■■■	5	8.1 (7.17)	11 (24.3)		
			8.9 (11.9)	16 (11.8)	14.2 (10.5)	20	1FT7064-5WK7-1 ■■■■	5	12.9 (11.4)	13.7 (30.2)		
Type of construction IM B5:		IM B5	Flange 0 Flange 1 (compatible with 1FT6)	0 1								
Connector outlet direction:		Connector size 1 and 1.5	Connector can be rotated	1								
		Connector size 3 ¹⁾	Transverse right Transverse left Axial NDE Axial DE	1 2 3 4								
Terminal box/cable entry:¹⁾		Top/transverse from right Top/transverse from left Top/axial from NDE Top/axial from DE		5 6 7 8								
Encoder systems for motors without DRIVE-CLiQ interface:		Incremental encoder sin/cos 1 V _{pp} 2048 S/R with C and D tracks (encoder IC2048S/R)		N								
		Absolute encoder EnDat 2048 S/R (encoder AM2048S/R)		M								
Shaft extension:		Shaft and flange accuracy:	Holding brake:									
Fitted key and keyway		Tolerance N	Without						A			
Fitted key and keyway		Tolerance N	With						B			
Fitted key and keyway		Tolerance R	Without						D			
Fitted key and keyway		Tolerance R	With						E			
Plain shaft		Tolerance N	Without						G			
Plain shaft		Tolerance N	With						H			
Plain shaft		Tolerance R	Without						K			
Plain shaft		Tolerance R	With						L			
Vibration magnitude:		Degree of protection:										
Grade A		IP64		0								
Grade A		IP65		1								
Grade A		IP67		2								
Grade R		IP64		3								
Grade R		IP65		4								
Grade R		IP67		5								

1.5 Selection and ordering data

1FT7 Compact liquid cooling, standard type

Motor type (repeated)	Efficiency ²⁾ η	Static current I_0 at M_0 $\Delta T=100$ K	Calculated power P_{calc} ⁶⁾ for M_0 $\Delta T=100$ K	Rated output current ³⁾ I_{rated}	Order No. Power Unit see at chapter "motor overview / power module assignment"	Power cable with complete shield		
						Motor connection (and brake connection) via power connector	Power connector	Cable cross-section ⁴⁾
	%	A	kW (HP)	A		Size	mm ²	Order No.
1FT7062-5WF7...	91	7.4	3.1 (4.16)	9		1	4 x 1.5	6FX002-5Q01-....
1FT7064-5WF7...	91	11.9	5.0 (6.71)	18		1	4 x 1.5	6FX002-5Q01-....
1FT7066-5WF7...	91	14	6.3 (8.45)	18		1	4 x 1.5	6FX002-5Q01-....
1FT7068-5WF7...	93	19	9.4 (12.6)	18 ⁵⁾		1	4 x 2.5	6FX002-5Q11-....
1FT7082-5WF7...	94	16	6.6 (8.85)	18		1.5	4 x 2.5	6FX002-5Q31-....
1FT7084-5WF7...	94	23	11.0 (14.8)	30		1.5	4 x 4	6FX002-5Q41-....
1FT7086-5WF7...	94	34	15.7 (21.1)	45		1.5	4 x 6	6FX002-5Q54-....
1FT7102-5WF7...	95	40	15.7 (21.1)	45		1.5	4 x 10	6FX002-5Q64-....
1FT7105-5WF7...	94	53.2	28.3 (38.0)	60		3	4 x 16	6FX002-5A23-....
1FT7108-5WF7...	95	65	39.3 (52.7)	85		3	4 x 16	6FX002-5A23-....
1FT7066-5WH7...	91	19.7	9.4 (12.6)	30		1	4 x 2.5	6FX002-5Q11-....
1FT7082-5WH7...	94	24	9.9 (13.3)	30		1.5	4 x 4	6FX002-5Q41-....
1FT7084-5WH7...	94	34.3	16.5 (22.1)	45		1.5	4 x 6	6FX002-5Q54-....
1FT7086-5WH7...	94	40.5	23.6 (31.6)	45		1.5	4 x 10	6FX002-5Q64-....
1FT7062-5WK7...	92	12.5	6.3 (8.5)	18		1	4 x 1.5	6FX002-5Q01-....
1FT7064-5WK7...	92	20.2	10.1 (13.5)	30		1	4 x 2.5	6FX002-5Q11-....

Power cable:			
MOTION-CONNECT 800	8		
MOTION-CONNECT 500	5		
Without brake cores		C	
With brake cores		D	
Length code		

Information about application, configuration and cable extensions can be found under Connection system MOTION-CONNECT.

- 1) Connector size 3 cannot be rotated. Terminal box can be chosen alternatively only for connector size 3.
- 2) Optimum efficiency in continuous duty.
- 3) With default setting of the pulse frequency.
- 4) The current carrying capacity of the power cables complies with EN 60204-1 for installation type C, for continuous duty at an ambient air temperature of 40 °C (104 °F).
- 5) With the specified Motor Module, the motor cannot be fully utilized with M_0 at $\Delta T = 100$ K winding temperature rise. If a Motor Module with a higher rating is used, you must check whether the specified power cable can be connected to it.
- 6) $P_{calc} [kW] = \frac{M_0 [Nm] \times n_{rated}}{9550}$ $P_{calc} [HP] = \frac{M_0 [lb_f-in] \times n_{rated}}{63000}$

1FT7 High Dynamic

Rated speed	Shaft height	Rated power	Static torque	Rated torque	Rated current	1FT7 High Dynamic synchronous motors Standard type Order No.	Number of pole pairs	Moment of inertia of rotor (without brake) J	Weight (without brake) m
n_{rated}	SH	P_{rated} at $\Delta T=100\text{ K}$	M_0 at $\Delta T=100\text{ K}$	M_{rated} at $\Delta T=100\text{ K}$	I_{rated} at $\Delta T=100\text{ K}$				
rpm		kW (HP)	Nm (lb _r -ft)	Nm (lb _r -ft)	A				
Forced ventilation									
3000	63	3.8 (5.10)	14 (10.3)	12 (8.85)	10.5	1FT7065-7SF7-1	5	6.4 (5.66)	19 (41.9)
		4.4 (5.90)	17 (12.5)	14 (10.3)	13	1FT7067-7SF7-1	5	8.3 (7.35)	23 (50.7)
	80	7.2 (9.66)	34 (25.1)	23 (17.0)	20	1FT7085-7SF7-1	5	20.7 (18.3)	34 (75.0)
		10.4 (13.9)	48 (35.4)	33 (24.3)	29	1FT7087-7SF7-1	5	27.4 (24.3)	42 (92.6)
4500	63	5.2 (6.97)	14 (10.3)	11 (8.11)	13.5	1FT7065-7SH7-1	5	6.4 (5.66)	19 (41.9)
		6.1 (8.18)	17 (12.5)	13 (9.59)	15	1FT7067-7SH7-1	5	8.3 (7.35)	23 (50.7)
	80	8.2 (11.0)	34 (25.1)	17.5 (12.9)	22.5	1FT7085-7SH7-1	5	20.7 (18.3)	34 (75.0)
		10.8 (14.5)	48 (35.4)	23 (17.0)	24	1FT7087-7SH7-1	5	27.4 (24.3)	43 (94.8)
Water cooling									
3000	63	5.7 (7.64)	19 (14.0)	18 (13.3)	15	1FT7065-7WF7-1	5	6.4 (5.66)	16 (35.3)
		7.4 (9.92)	25 (18.4)	23.5 (17.3)	21	1FT7067-7WF7-1	5	8.3 (7.35)	22 (48.5)
	80	11.9 (16.0)	43 (31.7)	38 (28.0)	32	1FT7085-7WF7-1	5	20.7 (18.3)	32 (70.6)
		16.0 (21.5)	61 (45.0)	51 (37.6)	43	1FT7087-7WF7-1	5	27.4 (24.3)	41 (90.4)
4500	63	7.8 (10.5)	19 (14.0)	16.5 (12.2)	20	1FT7065-7WH7-1	5	6.4 (5.66)	16 (35.3)
		10.4 (13.9)	25 (18.4)	22 (16.2)	25	1FT7067-7WH7-1	5	8.3 (7.35)	22 (48.5)
	80	15.6 (20.9)	43 (31.7)	33 (24.3)	48	1FT7085-7WH7-1	5	20.7 (18.3)	32 (70.6)
		21.7 (29.1)	61 (45.0)	46 (33.9)	53	1FT7087-7WH7-1	5	27.4 (24.3)	41 (90.4)
Type of construction:									
		IM B5	Flange 0	Flange 1 (compatible with 1FT6)	0				
					1				
Connector outlet direction:									
		Connector size 1 and 1.5	Connector can be rotated		1				
		Connector size 3 ¹⁾	Transverse right		1				
			Transverse left		2				
			Axial NDE		3				
			Axial DE		4				
Terminal box/cable entry:¹⁾									
		Top/transverse from right		5					
		Top/transverse from left		6					
		Top/axial from NDE		7					
		Top/axial from DE		8					
Encoder systems for motors without DRIVE-CLiQ interface:									
		Incremental encoder sin/cos 1 V _{pp} 2048 S/R with C and D tracks (encoder IC2048S/R)		N					
		Absolute encoder EnDat 2048 S/R (encoder AM2048S/R)		M					
Shaft extension:									
		Fitted key and keyway		Tolerance N	Without				A
		Fitted key and keyway		Tolerance N	With				B
		Fitted key and keyway		Tolerance R	Without				D
		Fitted key and keyway		Tolerance R	With				E
		Plain shaft		Tolerance N	Without				G
		Plain shaft		Tolerance N	With				H
		Plain shaft		Tolerance R	Without				K
		Plain shaft		Tolerance R	With				L
Vibration magnitude:									
		Grade A		IP64	0				
		Grade A		IP65	1				
		Grade A		IP67 (Only with water cooling)	2				
		Grade R		IP64	3				
		Grade R		IP65	4				
		Grade R		IP67 (Only with water cooling)	5				

1FT7 High Dynamic

Motor type (repeated)	Efficiency ²⁾ η %	Static current I_0 at M_0 $\Delta T=100$ K A	Calculated power P_{calc} ⁵⁾ P_{calc} for M_0 $\Delta T=100$ K kW (HP)	Rated output current ³⁾ I_{rated} A	Order No. Power Unit see at chapter "motor overview / power module assignment"	Power cable with complete shield		
						Motor connection (and brake connection) via power connector	Power connector Size	Cable cross-section ⁴⁾ mm ²
1FT7065-7SF7...	92	12	4.4 (5.90)	18		1.5	4 × 1.5	6FX002-5Q21-....
1FT7067-7SF7...	94	15	5.3 (7.11)	18		1.5	4 × 1.5	6FX002-5Q21-....
1FT7085-7SF7...	92	28	10.7 (14.3)	30		1.5	4 × 4	6FX002-5Q41-....
1FT7087-7SF7...	93	40	15.1 (20.2)	45		1.5	4 × 10	6FX002-5Q64-....
1FT7065-7SH7...	92	16	6.6 (8.85)	18		1.5	4 × 2.5	6FX002-5Q31-....
1FT7067-7SH7...	94	19	8.0 (10.7)	30		1.5	4 × 2.5	6FX002-5Q31-....
1FT7085-7SH7...	92	40	16.0 (21.5)	45		1.5	4 × 10	6FX002-5Q64-....
1FT7087-7SH7...	93	45	22.6 (30.3)	45		3	4 × 10	6FX002-5A13-....
1FT7065-7WF7...	92	16	6.0 (8.05)	18		1.5	4 × 2.5	6FX002-5Q31-....
1FT7067-7WF7...	94	22	7.9 (10.6)	30		1.5	4 × 4	6FX002-5Q41-....
1FT7085-7WF7...	93	36	13.5 (18.1)	45		1.5	4 × 6	6FX002-5Q54-....
1FT7087-7WF7...	94	51	19.2 (25.7)	60		3	4 × 16	6FX002-5A23-....
1FT7065-7WH7...	92	22	9.0 (12.1)	30		1.5	4 × 4	6FX002-5Q41-....
1FT7067-7WH7...	94	28	11.8 (15.8)	30		1.5	4 × 4	6FX002-5Q41-....
1FT7085-7WH7...	94	58	20.3 (27.2)	60		3	4 × 16	6FX002-5A23-....
1FT7087-7WH7...	94	67	28.7 (38.5)	85		3	4 × 25	6FX002-5DA33-....

Power cable:		
MOTION-CONNECT 800	8	
MOTION-CONNECT 500	5	
Without brake cores		C
With brake cores		D
Length code	

Information about application, configuration and cable extensions can be found under Connection system MOTION-CONNECT.

1) Connector size 3 cannot be rotated. Terminal box can be chosen alternatively only for connector size 3.

2) Optimum efficiency in continuous duty.

3) With default setting of the pulse frequency.

4) The current carrying capacity of the power cables complies with EN 60204-1 for installation type C, for continuous duty at an ambient air temperature of 40 °C (104 °F).

5) $P_{calc} [kW] = \frac{M_0 [Nm] \times n_{rated}}{9550}$ $P_{calc} [HP] = \frac{M_0 [lb_f-in] \times n_{rated}}{63000}$

1.6 Motor overview/power unit assignment

Table 1- 3 Naturally cooled motors

Motor type	n _N [rpm]	M _N (100k) [Nm]	I _N (100k) [A]	M ₀ (100k) [Nm]	I ₀ (100k) [A]	n _{max mech} [rpm]	SIMODRIVE Power Module	
							I _N [A]	Order no.
1FT7034-□AK7	6000	1.4	2.1	2	2.7	10000	3	6SN112□-1A□00-0HA1
1FT7036-□AK7	6000	1.7	2.4	3	4	10000	5	6SN112□-1A□00-0AA1
1FT7042-□AF7	3000	2.7	2.1	3	2.1	9000	3	6SN112□-1A□00-0HA1
1FT7042-□AK7	6000	2	3	3	3.9	9000	5	6SN112□-1A□00-0AA1
1FT7044-□AF7	3000	4.3	2.6	5	2.8	9000	3	6SN112□-1A□00-0HA1
1FT7044-□AK7	6000	2	2.5	5	5.7	9000	9	6SN112□-1A□00-0BA1
1FT7046-□AF7	3000	5.6	3.5	7	4	9000	5	6SN112□-1A□00-0AA1
1FT7046-□AH7	4500	2.4	3.2	7	8.1	9000	9	6SN112□-1A□00-0BA1
1FT7062-□AF7	3000	5.4	3.9	6	3.9	9000	5	6SN112□-1A□00-0AA1
1FT7062-□AK7	6000	3.3	5.4	6	8.4	9000	9	6SN112□-1A□00-0BA1
1FT7064-□AF7	3000	7.6	5.2	9	5.7	9000	9	6SN112□-1A□00-0BA1
1FT7064-□AK7	6000	2.9	3.4	9	9	9000	9	6SN112□-1A□00-0BA1
1FT7066-□AF7	3000	9.3	7.2	12	8.4	9000	9	6SN112□-1A□00-0BA1
1FT7066-□AH7	4500	5	6.3	12	13.6	9000	18	6SN112□-1A□00-0CA2
1FT7068-□AF7	3000	10.9	6.7	15	8.3	9000	9	6SN112□-1A□00-0BA1
1FT7082-□AC7	2000	11.4	4.9	13	5	8000	5	6SN112□-1A□00-0AA1
1FT7082-□AF7	3000	10.3	6.6	13	7.6	8000	9	6SN112□-1A□00-0BA1
1FT7082-□AH7	4500	8	7.8	13	12.3	8000	18	6SN112□-1A□00-0CA2
1FT7084-□AC7	2000	16.9	8.4	20	9	8000	9	6SN112□-1A□00-0BA1
1FT7084-□AF7	3000	14.5	8.5	20	11	8000	18	6SN112□-1A□00-0CA2
1FT7084-□AH7	4500	9.5	7.8	20	15.6	8000	18	6SN112□-1A□00-0CA2
1FT7086-□AC7	2000	22.5	9.2	28	10.6	8000	18	6SN112□-1A□00-0CA2
1FT7086-□AF7	3000	18	11	28	15.5	8000	18	6SN112□-1A□00-0CA2
1FT7086-□AH7	4500	10	10	28	22.4	8000	28	6SN112□-1AA00-0DA2
1FT7102-□AB7	1500	26	8	30	9	6000	9	6SN112□-1A□00-0BA1
1FT7102-□AC7	2000	24	10	30	12.5	6000	18	6SN112□-1A□00-0CA2
1FT7102-□AF7	3000	20	12	30	18	6000	18	6SN112□-1A□00-0CA2
1FT7105-□AB7	1500	42	13	50	15	6000	18	6SN112□-1A□00-0CA2
1FT7105-□AC7	2000	38	15	50	18	6000	18	6SN112□-1A□00-0CA2
1FT7105-□AF7	3000	28	15	50	26	6000	28	6SN112□-1AA00-0DA2
1FT7108-□AB7	1500	61	16	70	18	6000	18	6SN112□-1A□00-0CA2
1FT7108-□AC7	2000	50	18	70	25	6000	28	6SN112□-1AA00-0DA2

Description of the motors

1.6 Motor overview/power unit assignment

Motor type	n _N [rpm]	M _N (100K) [Nm]	I _N (100K) [A]	M ₀ (100K) [Nm]	I ₀ (100K) [A]	n _{max mech} [rpm]	SIMODRIVE Power Module	
							I _N [A]	Order no.
1FT7108-□AF7	3000	20	12	70	36	6000	56	6SN112□-1AA00-0EA2
		MLFB for SIMODRIVE power unit		6SN112□-1A□00-0□□□				
Note		3 = Power unit for internal cooling 4 = Power unit for external cooling						
The power unit for rated operation is specified in the table. A larger power unit may be required for peak-load operation.		A = Power unit in 1-axis design B = Power unit in 2-axis design (up to 18 A possible)						

Table 1-4 Motors with forced ventilation

Motor type	n _N [rpm]	M _N (100K) [Nm]	I _N (100K) [A]	M ₀ (100K) [Nm]	I ₀ (100K) [A]	n _{max mech} [rpm]	SIMODRIVE Power Module	
							I _N [A]	Order no.
1FT7084-5SC7	2000	24	13.5	27	15	8000	18	6SN112□-1A□00-0CA2
1FT7084-5SF7	3000	23	18.5	27	21	8000	28	6SN112□-1AA00-0DA2
1FT7084-5SH7	4500	21	24.5	27	30.5	8000	42	6SN112□-1AA00-0LA2
1FT7086-5SC7	2000	32	17	36	19.5	8000	28	6SN112□-1AA00-0DA2
1FT7086-5SF7	3000	29	24	36	29	8000	28	6SN112□-1AA00-0DA2
1FT7086-5SH7	4500	25	25	36	34	8000	42	6SN112□-1AA00-0LA2
1FT7105-5SC7	2000	56	29	65	31	6000	42	6SN112□-1AA00-0LA2
1FT7105-5SF7	3000	48	35	65	45	6000	56	6SN112□-1AA00-0EA2
		MLFB for SIMODRIVE power unit		6SN112□-1A□00-0□□□				
Note		3 = Power unit for internal cooling 4 = Power unit for external cooling						
The power unit for rated operation is specified in the table. A larger power unit may be required for peak-load operation.		A = Power unit in 1-axis design B = Power unit in 2-axis design (up to 18 A possible)						

Table 1-5 Liquid-cooled motors

Motor type	n _N [rpm]	M _N (100K) [Nm]	I _N (100K) [A]	M ₀ (100K) [Nm]	I ₀ (100K) [A]	n _{max mech} [rpm]	SIMODRIVE Power Module	
							I _N [A]	Order no.
1FT7062-5WF7	3000	10	7.8	10	7.4	9000	9	6SN112□-1A□00-0BA1
1FT7062-5WK7	6000	9.2	12.7	10	12.5	9000	18	6SN112□-1A□00-0CA2
1FT7064-5WF7	3000	16	14.5	16	11.9	9000	18	6SN112□-1A□00-0CA2
1FT7064-5WK7	6000	14.2	20	16	20.2	9000	28	6SN112□-1A□00-0DA2
1FT7066-5WF7	3000	19.6	14.4	20	14	9000	18	6SN112□-1A□00-0CA2
1FT7066-5WH7	4500	19.4	20.8	20	19.7	9000	28	6SN112□-1A□00-0DA2
1FT7068-5WF7	3000	29.6	19.6	30	19	9000	18	6SN112□-1A□00-0CA2

Motor type	n _N [rpm]	M _N (100K) [Nm]	I _N (100K) [A]	M ₀ (100K) [Nm]	I ₀ (100K) [A]	n _{max mech} [rpm]	SIMODRIVE Power Module	
							I _N [A]	Order no.
1FT7082-5WC7	2000	21	11	21	10.7	8000	18	6SN112□-1A□00-0CA2
1FT7082-5WF7	3000	20.5	16	21	16	8000	18	6SN112□-1A□00-0CA2
1FT7082-5WH7	4500	19	23.9	21	24	8000	28	6SN112□-1A□00-0DA2
1FT7084-5WC7	2000	35	17	35	16.5	8000	18	6SN112□-1A□00-0CA2
1FT7084-5WF7	3000	35	24.2	35	23	8000	28	6SN112□-1AA00-0DA2
1FT7084-5WH7	4500	32	34.5	35	34.3	8000	42	6SN112□-1AA00-0LA2
1FT7086-5WC7	2000	50	24	50	23	8000	28	6SN112□-1AA00-0DA2
1FT7086-5WF7	3000	49	36	50	34	8000	42	6SN112□-1AA00-0LA2
1FT7086-5WH7	4500	43	38	50	40.5	8000	42	6SN112□-1AA00-0LA2
1FT7102-5WB7	1500	50	20.3	50	17.8	6000	18	6SN112□-1A□00-0CA2
1FT7102-5WC7	2000	49.5	29.3	50	25.5	6000	28	6SN112□-1AA00-0DA2
1FT7102-5WF7	3000	45.5	38.8	50	40	6000	42	6SN112□-1AA00-0LA2
1FT7105-5WB7	1500	90	29.5	90	28.2	6000	28	6SN112□-1AA00-0DA2
1FT7105-5WC7	2000	90	40.8	90	39	6000	56	6SN112□-1AA00-0EA2
1FT7105-5WF7	3000	79	49.5	90	53.2	6000	56	6SN112□-1AA00-0EA2
1FT7108-5WB7	1500	125	40.3	125	39	6000	56	6SN112□-1AA00-0EA2
1FT7108-5WC7	2000	125	47.5	125	45.3	6000	56	6SN112□-1AA00-0EA2
1FT7108-5WF7	3000	109	60	125	65	6000	70	6SN112□-1AA00-0FA2
MLFB for SIMODRIVE power unit							6SN112□-1A□00-0□□□	
Note				3 = Power unit for internal cooling 4 = Power unit for external cooling				
The power unit for rated operation is specified in the table. A larger power unit may be required for peak-load operation.				A = Power unit in 1-axis design B = Power unit in 2-axis design (up to 18 A possible)				

Table 1- 6 1FT7 High Dynamic, motors with forced ventilation and liquid-cooled motors

Motor type	n _N [rpm]	M _N (100K) [Nm]	I _N (100K) [A]	M ₀ (100K) [Nm]	I ₀ (100K) [A]	n _{max mech} [rpm]	SIMODRIVE Power Module	
							I _N [A]	Order no.
Motors with forced ventilation								
1FT7065-7SF7	3000	12	10.5	14	12	9000	18	6SN112□-1A□00-0CA2
1FT7065-7SH7	4500	5.2	13.5	14	16	9000	18	6SN112□-1A□00-0CA2
1FT7067-7SF7	3000	14	13	17	15	9000	18	6SN112□-1A□00-0CA2
1FT7067-7SH7	4500	13	15	17	19	9000	28	6SN112□-1AA00-0DA2
1FT7085-7SF7	3000	23	20	34	28	8000	28	6SN112□-1AA00-0DA2
1FT7085-7SH7	4500	17.5	22.5	34	40	8000	42	6SN112□-1AA00-0LA2
1FT7087-7SF7	3000	33	29	48	40	8000	42	6SN112□-1AA00-0LA2
1FT7087-7SH7	4500	23	24	48	45	8000	56	6SN112□-1AA00-0EA2
Liquid-cooled motors								
1FT7065-7WF7	3000	18	15	19	16	9000	18	6SN112□-1A□00-0CA2
1FT7065-7WH7	4500	16.5	20	19	22	9000	28	6SN112□-1AA00-0DA2

1FT7 synchronous motors

Configuration Manual, (PFT7), 03/2010, 6SN1197-0AC13-0BP3

Description of the motors

1.6 Motor overview/power unit assignment

Motor type	n _N [rpm]	M _N (100K) [Nm]	I _N (100K) [A]	M ₀ (100K) [Nm]	I ₀ (100K) [A]	n _{max mech} [rpm]	SIMODRIVE Power Module	
							I _N [A]	Order no.
1FT7067-7WF7	3000	23.5	21	25	22	9000	28	6SN112□-1AA00-0DA2
1FT7067-7WH7	4500	22	25	25	28	9000	28	6SN112□-1AA00-0DA2
1FT7085-7WF7	3000	38	32	43	36	8000	42	6SN112□-1AA00-0LA2
1FT7085-7WH7	4500	33	48	43	58	8000	56	6SN112□-1AA00-0EA2
1FT7087-7WF7	3000	51	43	61	51	8000	56	6SN112□-1AA00-0EA2
1FT7087-7WH7	4500	46	53	61	67	8000	70	6SN112□-1AA00-0FA2

	MLFB for SIMODRIVE power unit	6SN112□-1A□□00-0□□□
<p>Note</p> <p>The power unit for rated operation is specified in the table. A larger power unit may be required for peak-load operation.</p>	<p>3 = Power unit for internal cooling 4 = Power unit for external cooling</p>	<p>A = Power unit in 1-axis design B = Power unit in 2-axis design (up to 18 A possible)</p>

2.1 SinuCom commissioning tool

The simple-to-use commissioning software for PC/PG on machine tools serves to ensure optimum commissioning of drives with SINAMICS S120/SIMODRIVE 611 digital. You will find a description in the Intranet under the following address:

<https://mall.automation.siemens.com>

Select your country and then in the menu bar "Products".

In the navigator, select "Automation Systems" → "SINUMERIK CNC automation systems" → "HMI software for CNC controls" → "Tools" → "SinuCom".

2.2 NCSD Configurator

The NCSD Configurator is an intelligent selection tool used to configure SINUMERIK and SIMODRIVE components. Customized plants and systems can be simply and quickly engineered - from selecting the CNC control through the assignment of the operator components up to the drive configuration.

Benefits

- Simple tree-like structure and transparent navigation
- Variable module selection and sequence
- Configuration of sub-components and total plants and systems
- The order can be optimized by immediately re-calculating when changes are made to the configuration
- All of the selected components are continuously checked for consistency and that they can actually be used in conjunction with one another
- A parts list that has been generated can be transferred into the interactive Catalog CA 01
- The parts list can be completed by freely entering Order Nos.
- Languages: German, English, French, Italian and Spanish

CNC control, operator components, HMI software, SIMATIC S7-300 I/O, converter system, motors and measuring system are selected in a harmonized unified way as overall system. Motors can be selected using the Order No. or using a motor Wizard by specifying the speed, torque and power rating. The motor is automatically assigned to the matching power module and the appropriate cables. The cable length can then be defined as a function of the application.

The NCSD Configurator provides information about:

- Design and configuration of the SINUMERIK components
- Design and configuration of the SIMODRIVE group
- Motor data and options for core motor types
- DC link power and capacitance
- Assessment points (electronic and gating points)
- Calculating the power loss for cabinet components

Software update service, repair service contract, documentation and service/maintenance contracts for the individual components are also implemented in the NCSD Configurator.

You can obtain the NCSD Configurator as follows:

- Together with the interactive CA 01 Catalog, or
- Continually updated in the Internet under:

www.siemens.com/sinumerik

2.3 Procedure when engineering

Motion control

Servo drives are optimized for motion control applications. They execute linear or rotary movements within a defined movement cycle. All movements should be optimized in terms of time.

As a result of these considerations, servo drives must meet the following requirements:

- High dynamic response, i.e. short rise times
- Overload capability, i.e. a high reserve for accelerating
- Wide control range, i.e. high resolution for precise positioning.

The following table "Configuring procedure" is valid for synchronous and induction motors.

General procedure when engineering

The function description of the machine provides the basis when engineering the drive application. The definition of the components is based on physical interdependencies and is usually carried-out as follows:

Table 2- 1 Configuring procedure

step	Description of the engineering activity	
1.	Clarification of the type of drive	Refer to the next chapter
2.	Definition of supplementary conditions and integration into an automation system	
3.	The load is defined, the max. load torque is calculated, and the motor selected	
4.	The power section is selected	Refer to catalog
5.	Steps 3 and 4 are repeated for additional axes	
6.	The required DC link power is calculated and the infeed module or infeed/regenerative feedback module is defined	
7.	The line-side options (main switch, fuses, line filters, etc.) are selected	
8.	The required control performance is specified, control modules are selected and the component cabling is defined	
9.	Other system components (e.g. braking resistors) are defined	
10.	The current demand of the 24 V DC supply for the components is calculated and the power supplies (SITOP devices, Control Supply Modules) are specified	
11.	The components for the connection system are selected	
12.	The components of the drive group are configured to form a complete drive	
13.	The required cable cross sections for power supply and motor connections are calculated	
14.	Mandatory installation clearances must be taken into account	

2.3.1 Clarification of the type of drive

The motor is selected on the basis of the required torque, which is defined by the application, e.g. traveling drives, hoisting drives, test stands, centrifuges, paper and rolling mill drives, feed drives or main spindle drives. Gearboxes to convert motion or to adapt the motor speed and motor torque to the load conditions must also be considered.

As well as the load torque, which is determined by the application, the following mechanical data is among those required to calculate the torque to be provided by the motor:

- Masses to be moved
- Diameter of the drive wheel
- Leadscrew pitch, gear ratios
- Frictional resistance
- Mechanical efficiency
- Traversing paths
- Maximum velocity
- Maximum acceleration and maximum deceleration
- Cycle time

2.3.2 Defining the supplementary conditions and integration into an automation system

You must decide whether synchronous or induction motors are to be used.

Synchronous motors are the best choice if it is important to have low envelope dimensions, low rotor moment of inertia and therefore maximum dynamic response ("Servo" control type).

Induction motors can be used to increase maximum speeds in the field weakening range. Induction motors for higher power ratings are also available.

The following factors are especially important when engineering a drive application:

- The line system configuration, when using specific types of motor and/or line filters on IT systems (non-grounded systems)
- The utilization of the motor in accordance with rated values for winding temperature rise 60 K or 100 K (for synchronous motors).
- The ambient temperatures and the installation altitude of the motors and drive components.
- Heat dissipation from the motors through natural ventilation, forced ventilation or water cooling

Other constraints apply when integrating the drives into an automation environment such as SINUMERIK or SIMOTION.

For motion control and technology functions (e.g. positioning), as well as for synchronous operation functions, the corresponding automation system, e.g. SIMOTION D, is used.

2.3.3 Definition of the load, calculation of max. load torque and definition of the motor

The motor-specific limiting characteristics provide the basis for defining the motors.

These define the torque or power characteristic versus the speed and take into account the motor limits based on the DC link voltage. The DC link voltage is dependent on the line voltage. In the case of torque drive the DC link voltage is dependent on the type of Line Module and the type of infeed module or infeed/regenerative feedback module.

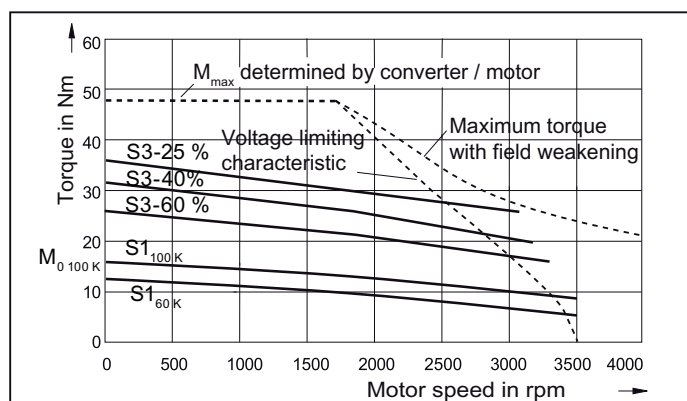

Figure 2-1 Limit characteristics for synchronous motors

The motor is selected based on the load which is specified by the application. Different characteristic curves must be used for different load events.

The following operating scenarios have been defined:

- Load duty cycle with constant ON period
- Load duty cycles with varying ON period
- Free duty cycle

The objective is to identify characteristic torque and speed operating points, on the basis of which the motor can be selected depending on the particular load.

Once the operating scenario has been defined and specified, the maximum motor torque is calculated. Generally, the maximum motor torque is required when accelerating. The load torque and the torque required to accelerate the motor are added.

The maximum motor torque is then verified with the limiting characteristic curves of the motors.

The following criteria must be taken into account when selecting the motor:

- The dynamic limits must be adhered to, i.e., all speed-torque points of the relevant load event must lie below the relevant limiting characteristic curve.
- The thermal limits must be adhered to, i.e. the RMS motor torque at the average motor speed resulting from the duty cycle must lie below the S1 characteristic curve (continuous duty).

Load duty cycles with constant on period

For duty cycles with constant ON period, there are specific requirements for the torque characteristic curve as a function of the speed, for example:

$M = \text{constant}$, $M \sim n^2$, $M \sim n$ or $P = \text{constant}$.

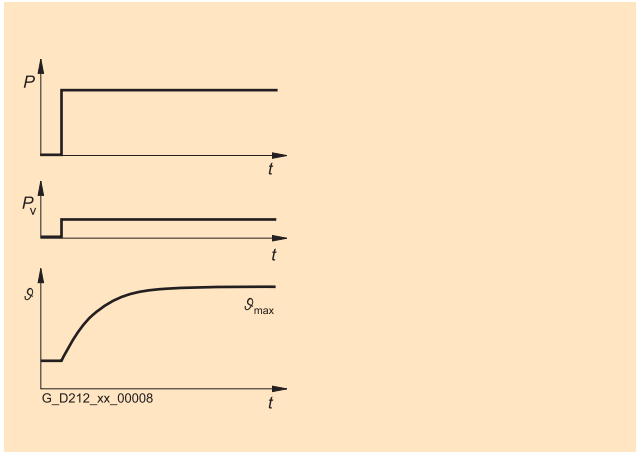

Figure 2-2 S1 duty (continuous operation)

These drives typically operate at a specific operating point. Drives such as these are dimensioned for a base load. The base load torque must lie below the S1 characteristic curve. In the event of transient overloads (e.g. when accelerating) an overload has to be taken into consideration. The overload current must be calculated relative to the required overload torque. The peak torque must lie below the voltage limiting characteristic.

In summary, the motor is selected as follows:

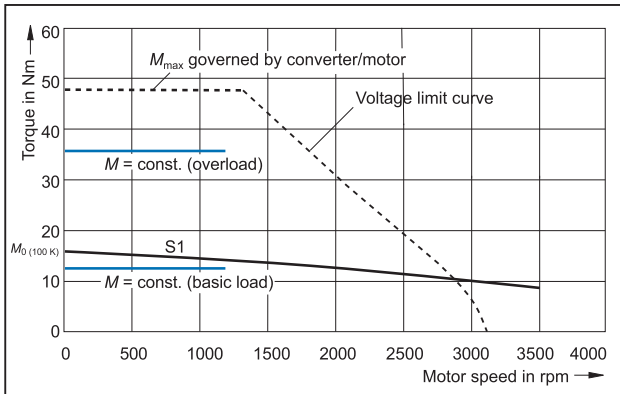

Figure 2-3 Selection of motors for load duty cycles with constant on period (examples)

Load duty cycles with varying on period

As well as continuous duty (S1), standard intermittent duty types (S3) are also defined for load duty cycles with varying on periods. This involves operation that comprises a sequence of similar load cycles, each of which comprises a time with constant load and an off period.

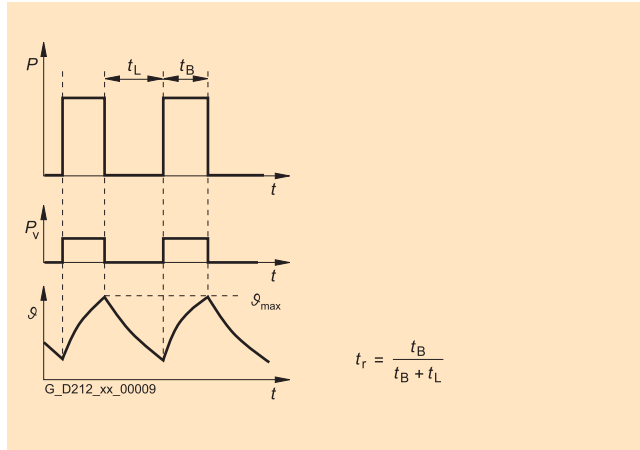

Figure 2-4 S3 duty (intermittent operation without influencing starting)

Fixed variables are usually used for the relative on period:

- S3 – 60%
- S3 – 40%
- S3 – 25%

The corresponding motor characteristics are provided for these specifications. The load torque must lie below the corresponding thermal limiting characteristic curve of the motor. An overload must be taken into consideration for load duty cycles with varying on periods.

Free duty cycle

A load duty cycle defines the characteristics of the motor speed and the torque with respect to time.

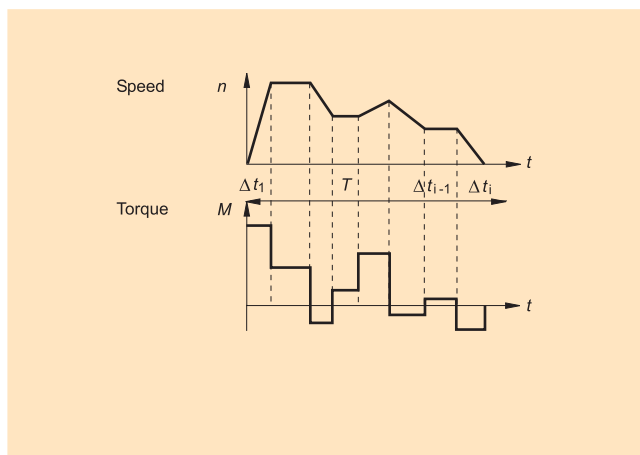

Figure 2-5 Example of a load duty cycle

A load torque is specified for each time period. In addition to the load torque, the average load moment of inertia and motor moment of inertia must be taken into account for acceleration. It may be necessary to take into account a frictional torque that opposes the direction of motion.

When a gearbox is mounted:

The gear ratio and gear efficiency must be taken into account when calculating the load and/or accelerating torque to be provided by the motor. A higher gear ratio increases positioning accuracy in terms of encoder resolution. For any given motor encoder resolution, as the gear ratio increases, so does the resolution of the machine position to be detected.

Note

The following formulas can be used for duty cycles outside the field weakening range. For duty cycles in the field weakening range, the drive system must be engineered using the SIZER engineering tool.

For the motor torque in a time slice Δt_i the following applies:

$$M_{Mot, i} = (J_M + J_G) \cdot \frac{2\pi}{60} \cdot \frac{\Delta n_{Last, i}}{\Delta t_i} \cdot i + \left(J_{Last} \cdot \frac{2\pi}{60} \cdot \frac{\Delta n_{Last, i}}{\Delta t_i} + M_{Last, i} + M_R \right) \cdot \frac{1}{i \cdot \eta_G}$$

The motor speed is:

$$n_{Mot, i} = n_{Last, i} \cdot i$$

The RMS torque is obtained as follows:

$$M_{Mot, eff} = \sqrt{\frac{\sum M_{Mot, i}^2 \cdot \Delta t_i}{T}}$$

The average motor speed is calculated as follows:

$$n_{Mot, mittel} = \frac{\sum n_{Mot, k, A} + n_{Mot, k, E} \cdot \Delta t_i}{\frac{2}{T}}$$

J_M	Motor moment of inertia
J_G	Gearbox moment of inertia
J_{load}	Load moment of inertia
n_{Load}	Load speed
i	Gear ratio
η_G	Gearbox efficiency
M_{load}	Load torque
M_R	Frictional torque
T	Cycle time, clock cycle time
A; E	Initial value, final value in time slice Δt_i
t_e	ON period
Δt_i	Time interval

The RMS torque M_{rms} must lie below the S1 curve.

The maximum torque M_{\max} is produced during the acceleration operation. M_{\max} must lie below the voltage limiting characteristic curve. In summary, the motor is selected as follows:

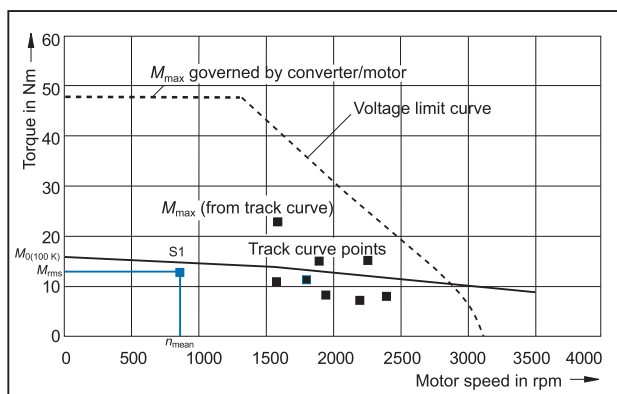

Figure 2-6 Selecting motors depending on the load duty cycle (example)

Specification of the motor

Through variation, it is now possible to identify a motor which meets the requirements of the application (duty cycle).

In a second step, a check is made as to whether the thermal limits are maintained. To do this, the motor current at the base load must be calculated. The calculation depends on the type of motor used (synchronous motor, induction motor) and the particular application (duty cycle). When configuring according to duty cycle with constant ON period with overload, the overload current must be calculated relative to the required overload torque.

Finally, the other motor features must be defined by configuring the motor options.

Mechanical properties of the motors

3.1 Cooling

3.1.1 Natural cooling

For naturally cooled motors, the heat loss is dissipated through thermal conduction, radiation and natural convection. As a consequence, adequate heat dissipation must be guaranteed by suitably mounting the motor.

To ensure sufficient cooling, a minimum clearance of 100 mm from adjacent components must be observed on three sides.

The rated data only applies when the ambient temperature does not exceed 40 °C (104 °F) as a result of the installation conditions.

3.1.2 Forced ventilation

This cooling method is implemented by means of a separate ventilation module equipped with a ventilator that operates independently of the motor. The fan is available with degree of protection IP54.

DANGER

Forced ventilation cannot be used in the presence of flammable, corrosive, electrically conductive or explosive dust.

NOTICE

Steps must be taken to ensure that the motor is always operated in conjunction with the separately driven fan.

The motors must be arranged in such a way that the cooling air can flow in and out without obstruction and that the minimum clearances between the inlet/outlet air openings and adjacent components is maintained (see "Minimum clearance" diagram below).

3.1 Cooling

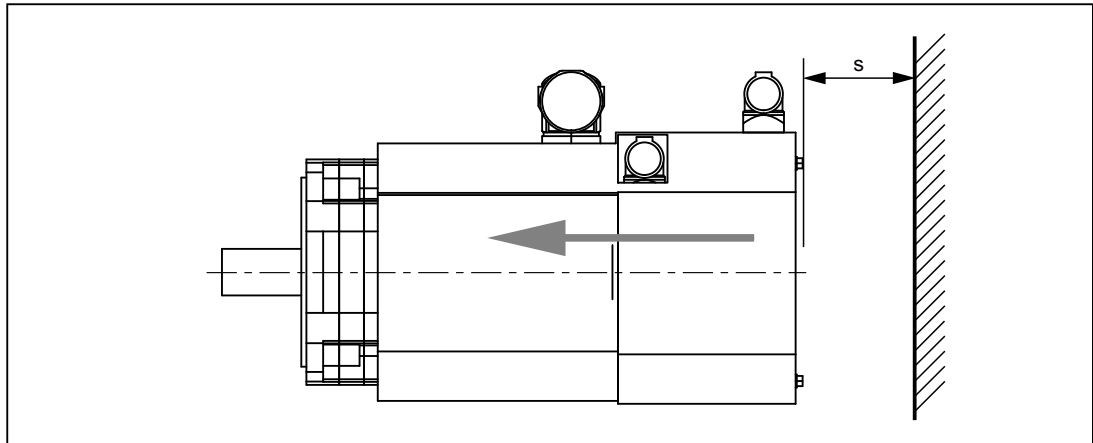

- s A minimum clearance of 30 mm applies for SH 63 and SH 80.
A minimum clearance of 50 mm applies for SH 100.

Figure 3-1 Minimum clearance s

Steps must be taken to ensure that hot outlet air cannot be drawn back into the system. The direction of air flow is from the non-drive end (NDE) to the drive end (DE). The fan may only be operated with normal ambient air, as air containing chemical or conductive impurities could cause the fan to fail prematurely. Deposits from contaminated air could result in poor heat transfer at the motor or could cause the cooling-air duct to become clogged, leading to an overheated motor.

Mechanical changes to the motors compared to natural cooling

- The power connector is about 12 mm higher.
- A sheet metal envelope is pushed over the motor frame from the non-drive end. The axial fan is mounted in this sheet metal envelope. There is a cut-out in the sheet metal envelope at the connector positions. This means that the motor is only partially cooled by the air flow (three-sided ventilation).
- For the motor dimensions, refer to the dimension drawings.
- With forced ventilation, the signal connector is not rotatable (seeConnecting the external fan (Page 290)).

3.1.3 Water cooling

 WARNING
The equipment must be safely disconnected from the supply before any installation or service work is carried out on cooling circuit components.
Only qualified personnel may design, install and commission the cooling circuit.

3.1.3.1 Cooling circuit

The electrochemical processes that take place in a cooling system must be minimized by choosing the right materials. For this reason, mixed installations, i.e. a combination of different materials, such as copper, brass, iron, or halogenated plastic (PVC hoses and seals), should not be used or limited to the absolutely essential minimum.

A differentiation is made between 3 different cooling circuits:

- Closed cooling circuit
- Semi-open cooling circuit
- Open cooling circuit

Table 3- 1 Description of the various cooling circuits

Definition	Description
Closed cooling circuit	The pressure equalizing tank is closed (oxygen cannot enter the system) and has a pressure relief valve. The coolant is only routed in the motors and converters as well as the components required to dissipate heat.
Semi-open cooling circuit	Oxygen can only enter the cooling system through the pressure equalization tank, otherwise the same as "closed cooling circuit".
Open cooling circuit (tower system)	The coolant is cooled in a tower. In this case, there is intensive oxygen contact.

Note

Cooling circuits

Only closed and semi-open cooling circuits are permissible for motors. Converter systems must be connected before the motors in the cooling circuit.

3.1 Cooling

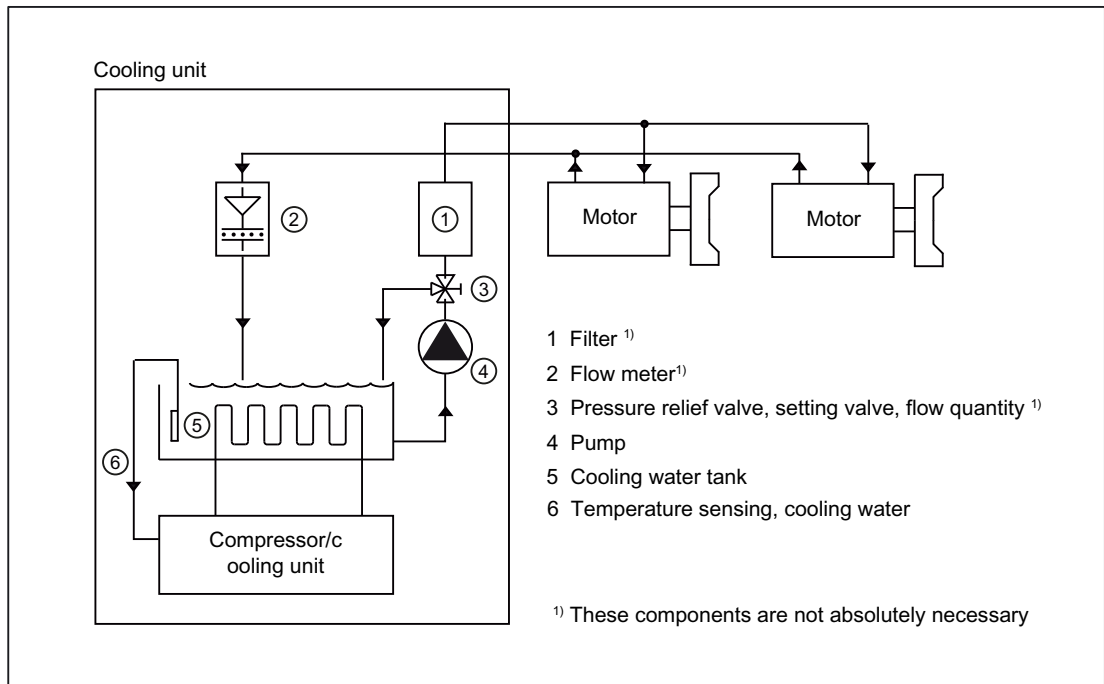

Figure 3-2 Example of a semi-open cooling circuit

Equipotential bonding

All components in the cooling system (motor, heat exchanger, piping system, pump, pressure equalization tank, etc.) must be connected to an equipotential bonding system. This is implemented using a copper bar or finely stranded copper cable with the appropriate cable cross-sections.

NOTICE

Under no circumstances may the coolant pipes come into contact with live components. There must always be an isolating clearance of > 13 mm! The pipes must be securely mounted and checked for leaks.

Materials used in the motor cooling circuit

The materials used in the cooling circuit must be coordinated with the materials in the motor.

Table 3-2 Materials used in the motor cooling circuit

Shaft height	Bearing shield	Pipes in the stator
1FT706x	Cast iron (EN-GJL-200)	Stainless steel
1FT708x	Cast iron (EN-GJL-200)	Stainless steel
1FT710x	Cast iron (EN-GJL-200)	Stainless steel

Materials and components in the cooling circuit

The following table lists a wide variety of materials and components which may or may not be used in a cooling circuit.

Table 3- 3 Materials and components of a cooling circuit

Material	Used as	Description
Zinc	Pipes, valves and fittings	Use is not permitted.
Brass	Pipes, valves and fittings	Can be used in closed circuits with inhibitor.
Copper	Pipes, valves and fittings	Can be used only in closed circuits with inhibitors in which the heat sink and copper component are separated (e.g. connection hose on units).
Common steel (e.g. St37)	Pipes	Permissible in closed circuits and semi-open circuits with inhibitors or Antifrogen N, check for oxide formation, inspection window recommended.
Cast steel, cast iron	Pipes, motors	Closed circuit and use of strainers and flushback filters. Fe separator for stainless heat sink.
High-alloy steel, Group 1 (V2A)	Pipes, valves and fittings	Can be used for drinking or municipal water with a chloride content up to <250 ppm, suitable according to definition in Chapter "Coolant definition".
High-alloy steel, Group 2 (V4A)	Pipes, valves and fittings	Can be used for drinking or municipal water with a chloride content up to <500 ppm, suitable according to definition in Chapter "Coolant definition".
ABS (AcrylnitrileButadieneStyrene)	Pipes, valves and fittings	Suitable according to the definition in Chapter "Coolant definition". Suitable for mixing with inhibitor and/or biocide as well as Antifrogen N.
Installation comprising different materials (mixed installation)	Pipes, valves and fittings	Use is not permitted.
PVC	Pipes, valves, fittings and hoses	Use is not permitted.
Hoses		Reduce the use of hoses to a minimum (device connection). Must not be used as the main pipe for the whole system. Recommendation: EPDM hoses with an electrical resistance $> 10^9 \Omega$ (e.g. Semperflex FKD supplied from Semperit or DEMITTEL; from PE/EPD, supplied from Telle).
Gaskets	Pipes, valves and fittings	Use of FPM (Viton), AFM34, EPDM is recommended.
Hose connections	Transition Hose - pipe	Secure with clips conforming to DIN 2817, available e.g. from Telle.

The following recommendation applies in order to achieve an optimum motor heatsink (enclosure) lifetime:

- Engineer a closed cooling circuit with cooling unit manufactured out of stainless steel that dissipates the heat through a water-water heat exchanger.
- All other components such as cooling circuit cables and fittings manufactured out of ABS, stainless steel or general construction steel.

3.1 Cooling

Cooling system manufacturers

BKW Kälte-Wärme-Versorgungstechnik GmbH	http://www.bkw-kuema.de
DELTATHERM Hirmer GmbH	http://www.deltatherm.de
Glen Dimplex Deutschland GmbH	http://www.riedel-cooling.com
Helmut Schimpke und Team Industriekühlanlagen GmbH + Co. KG	http://www.schimpke.org
Hydac System GmbH	http://www.hydac.com
Hyfra Industriekühlanlagen GmbH	http://www.hyfra.de
KKT Kraus Kälte- und Klimatechnik GmbH	http://www.kkt-kraus.de
Pfannenberg GmbH	http://www.pfannenberg.com
Rittal GmbH & Co. KG	http://www.rittal.de

Note

It goes without saying that equivalent products from other manufacturers may be used. Our recommendations should be considered as such. We cannot accept any liability for the quality and properties/features of third-party products.

3.1.3.2 Engineering the cooling circuit

Pressure

The operating pressure must be set according to the flow conditions in the supply and return lines of the cooling circuit. The required coolant flow rate per time unit must be set according to the technical data of the equipment and motors.

The maximum permissible pressure with respect to atmosphere in the heat sink and thus in the cooling circuit must not exceed 0.6 MPa (6 bar) If a pump that can achieve a higher pressure is used, suitable measures must be provided on the system side (e.g. safety valve $p \leq 0.6$ MPa, pressure control etc.) to ensure that the maximum pressure is not exceeded.

The pressure difference between the coolant in the supply and return lines should be selected as low as possible so that pumps with a flat characteristic can be used.

An additional flushback filter should be used in the circuit in order to help prevent blockages and corrosion. This allows any material deposits to be flushed out in operation.

Pressure drop in the motor

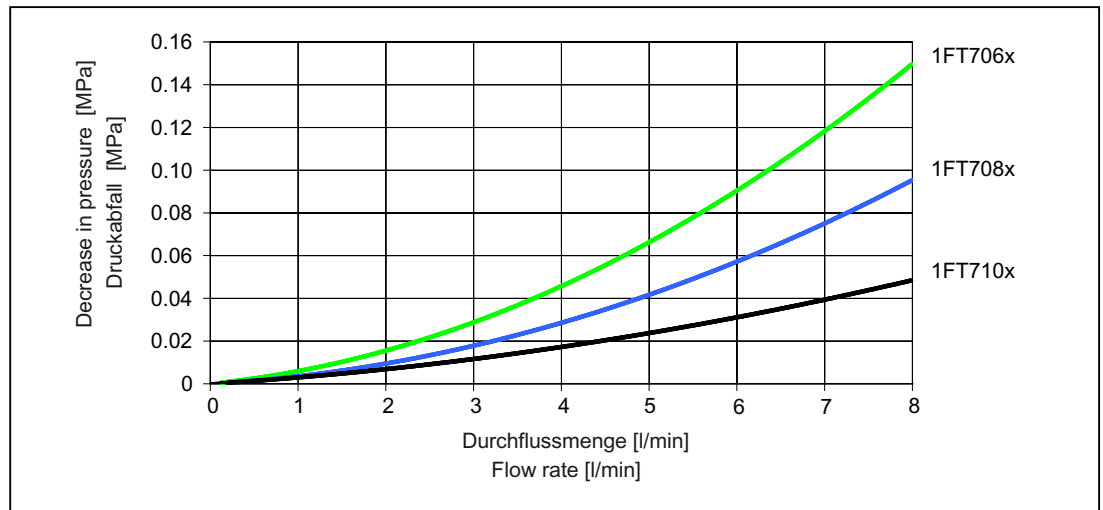

Figure 3-3 Pressure drop 1FT7

The nominal coolant flows specified in the following table must be maintained in order to ensure sufficient cooling.

Table 3- 4 Pressure drop at the nominal coolant flow

Shaft height	Flow rate	Pressure drop
1FT706x	3 l/min	0.03 MPa
1FT708x	4 l/min	0.03 MPa
1FT710x	5 l/min	0.025 MPa

Pressure equalization

If various components are connected up in the cooling circuit, it may be necessary to provide pressure equalization.

Note

Reactor elements must be fitted at the coolant outlet for the motor or the relevant component!

Avoiding cavitation

During uninterrupted duty, the pressure drop by an inverter or motor must not exceed 0.2 MPa (2 bar). Otherwise, the high flow rate results in damage due to cavitation and/or abrasion.

3.1 Cooling

Connecting motors in series

For the following reasons, connecting motors in series can only be conditionally recommended:

- The required flow rates of the motors must be approximately the same (< a factor of 2)
- An increase in the coolant temperature can result in having to derate the second or third motor if the maximum coolant inlet temperature is exceeded.

Coolant inlet temperature

CAUTION
The coolant inlet temperature must be selected so that condensation does not form on the surface of the motor: $T_{cooling} > T_{ambient} - 5\text{ K}$

The motors are designed for operation up to a coolant inlet temperature of +30 °C, but still maintaining all of the specified motor data. If the coolant inlet temperature deviates from this, the continuous torque will change (see the table titled "Derating factors").

Table 3- 5 Derating factors

Coolant inlet temperature	≤ 30 °C	35 °C	40 °C	45 °C
Derating factor	1.0	0.97	0.95	0.92

Cooling power to be dissipated

The specified values refer to operation at the rated speed with rated torque. The cooling water temperature must be < 30 °C.

Table 3- 6 Cooling power to be dissipated 1FT7 Compact

Motor type	Cooling power to be dissipated [W]
1FT7062-5WF7	450
1FT7062-5WK7	600
1FT7064-5WF7	650
1FT7064-5WK7	950
1FT7066-5WF7	700
1FT7066-5WH7	1000
1FT7068-5WF7	750
1FT7082-5WC7	500
1FT7082-5WF7	600
1FT7082-5WH7	800
1FT7084-5WC7	800
1FT7084-5WF7	1000
1FT7084-5WH7	1300
1FT7086-5WC7	1000
1FT7086-5WF7	1400

Motor type	Cooling power to be dissipated [W]
1FT7086-5WH7	1600
1FT7102-5WB7	1000
1FT7102-5WC7	1200
1FT7102-5WF7	1400
1FT7105-5WB7	1200
1FT7105-5WC7	1600
1FT7105-5WF7	1900
1FT7108-5WB7	1500
1FT7108-5WC7	1800
1FT7108-5WF7	1900

Table 3- 7 Cooling power to be dissipated 1FT7 High Dynamic

Motor type	Cooling power to be dissipated [W]
1FT7065-7WF7	700
1FT7065-7WH7	750
1FT7067-7WF7	800
1FT7067-7WH7	900
1FT7085-7WF7	1100
1FT7085-7WH7	1200
1FT7087-7WF7	1300
1FT7087-7WH7	1500

3.1.3.3 Coolant

Table 3- 8 Water specifications for coolant

	Quality of the water used as coolant for motors with aluminum, stainless steel tubes + cast iron or steel jacket
Chloride ions	< 40 ppm, can be achieved by adding deionized water.
Sulfate ions	< 50 ppm
Nitrate ions	< 50 ppm
pH value	6 ... 9 (for aluminum 6 ... 8)
Electrical conductivity	< 500 µS/cm
Total hardness	< 170 ppm

3.1 Cooling

Note

It is recommended to use deionized water with reduced conductivity (5 ... 10 $\mu\text{S}/\text{cm}$) (if required, ask the water utility for the values). According to 98/83/EC, drinking water may contain up to 2500 ppm of chloride!

Manufacturers of chemical additives can provide support when analyzing the water that is available on the plant side.

Table 3- 9 Coolant quality

	Coolant quality
Cooling water	According to the table "Water specifications for cooling water"
Corrosion protection	0.2 to 0.25 % inhibitor, Nalco TRAC100 (previously 0GE056)
Anti-freeze protection	When required, 20 - 30 % Antifrogen N (from the Clariant Company)
Dissolved solids	< 340 ppm
Size of particles in the coolant	< 100 μm

Note

The inhibitor is not required if it ensured that the concentration of Antifrogen N is > 20%.

Derating is necessary when the coolant has an antifreeze content of > 30% (see Other coolants (Page 57)).

Other coolants (not water-based)

When using other coolants (e.g. oil, cooling lubricating medium) derating may be required in order that the thermal motor limit is not exceeded. The derating can be determined using the following data at a temperature of 30 °C:

Density	ρ	[kg/m^3]
Specific thermal capacitance	c_p	[$\text{J}/(\text{kg}\cdot\text{K})$]
Thermal conductivity	λ	[$\text{W}/(\text{K}\cdot\text{m})$]
Kinematic viscosity	ν	[m^2/s]
Flow rate	V	[rpm]

An inquiry must be set to the manufacturer's plant (Siemens Service Center).

Note

Oil-water mixtures with more than 10% require derating.

Biocide

Closed cooling circuits with soft water are susceptible to microbes. The risk of corrosion caused by microbes is virtually non-existent in chlorinated drinking water systems.

Antifrogen N has a biocidal effect even at the minimum required concentration of > 20 %. No strain of bacteria can survive if >20 % Antifrogen N is added.

The suitability of a biocide depends on the type of microbe. The following types of microbes are encountered in practice:

- Slime-forming bacteria
- Corrosive bacteria
- Iron-depositing bacteria

At least one water analysis per annum is recommended to determine the number of bacterial colonies. Suitable biocides are available from the manufacturer Nalco for example. The manufacturer's recommendations must be followed regarding the concentration and compatibility with any inhibitor used.

NOTICE
Biocides and Antifrogen N must not be mixed.

There are other manufacturers of chemical additives in the market. Equivalent products from other manufacturers may be used. The suitability must be checked by testing.

Manufacturers of chemical additives

Tyforop Chemie GmbH	http://www.tyfo.de
Clariant Produkte Deutschland GmbH	http://www.antifrogen.de
Cimcool Industrial Products	http://www.cimcool.net
FUCHS PETROLUB AG	http://www.fuchs-oil.com
Hebro chemie GmbH	http://www.hebro-chemie.de
HOUGHTON Deutschland GmbH	http://www.houghton.com
Nalco Deutschland GmbH	http://www.nalco.com
Schweitzer-Chemie GmbH	http://www.schweitzer-chemie.de

Note

It goes without saying that equivalent products from other manufacturers may be used. Our recommendations should be considered as such. We cannot accept any liability for the quality and properties/features of third-party products.

3.1 Cooling

3.1.3.4 Coolant connection

The motor is connected to the cooling circuit by means of two female threads on the rear of the motor. Which one is the inlet and which one is the outlet can be freely connected.

Coolant connection for 1FT7: G 1/4 "

The units should be connected with hoses to provide mechanical decoupling (refer to the table "Materials and components of a cooling circuit").

3.1.3.5 Commissioning

When required, before connecting the motors and converters to the cooling circuit, the pipes should be flushed in order to avoid dirt entering the motors and converters.

After the units have been installed in the plant, the coolant circuit must be commissioned before the electrical systems.

Maintenance and service

It is recommended that the filling level and discoloration or turbidity of the coolant is checked at least once a year. Further, every year it must be checked as to whether the coolant still has the permissible specification.

If the coolant level has dropped, the loss should be corrected on closed or semi-open circuits with a prepared mixture of deionized water and inhibitor or Antifrogen N.

3.2 Flange forms

Table 3- 10 Flange forms

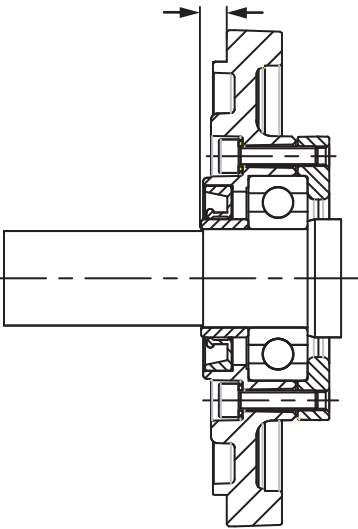
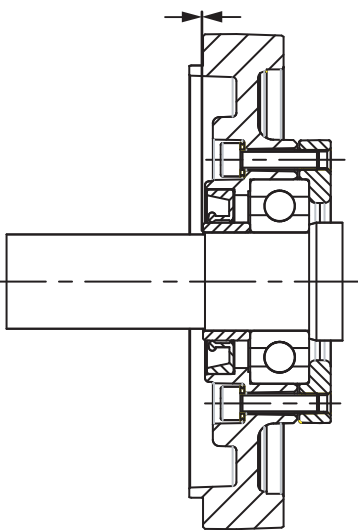
Designation	Representation	Description
Flange 0		Flange 0, recessed 1FT7□□□-□□□□0-□□□□
Flange 1		Flange 1, compatible with 1FT6 motors 1FT7□□□-□□□□1-□□□□

3.3 Degree of protection

Degree of protection designation

The degree of protection designation in accordance with EN 60034-5 (IEC 60034-5) is described using the letters "IP" and two digits (e.g. IP64).

IP = International Protection

1st digit = protection against ingress of foreign bodies

2nd digit = protection against harmful ingress of water

Since most cooling lubricants used in machine tools and transfer machines are oily, creep-capable, and/or corrosive, protection against water alone is insufficient. The motors must be protected by suitable covers.

Attention must be paid to providing suitable sealing of the motor shaft for the selected degree of protection for the motor.

Sealing air connection

Note

For critical applications with highly creep-capable media, the 1FT7 motors can be ordered with a sealing air connection (only in conjunction with IP67) via the Z option Q12.

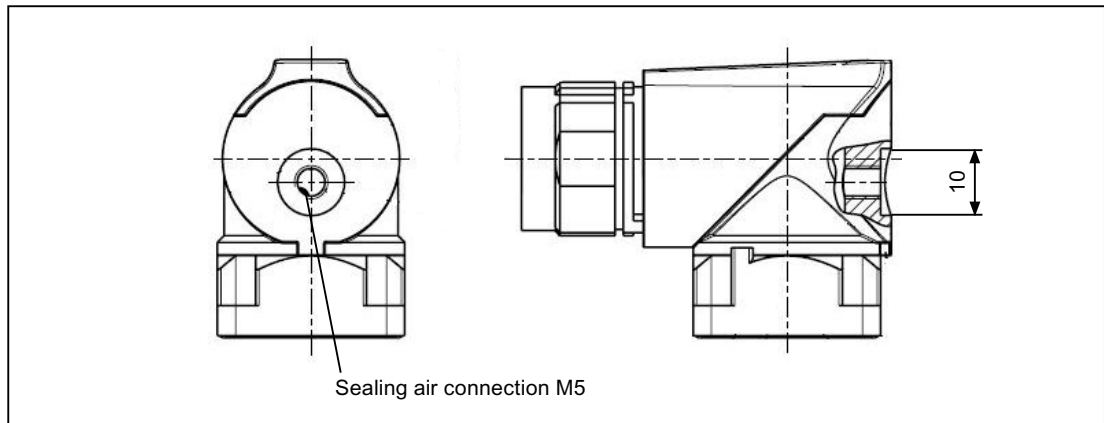

Figure 3-4 Sealing air connection

As delivered from the factory, the sealing air connection is sealed with a plastic plug.

Technical data for sealing air connection

- Connecting thread M5
- Gauge pressure from 0.05 mbar to 0.1 bar
- Compressed air must be dried and cleaned (entrained particles > 3 µm not permissible)

Sealing of the motor shaft

Table 3- 11 Motor shaft sealing

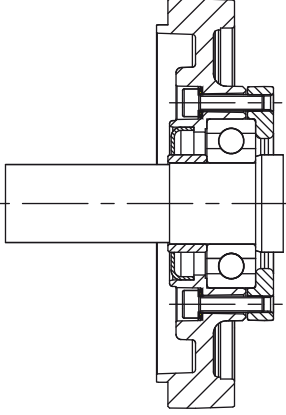
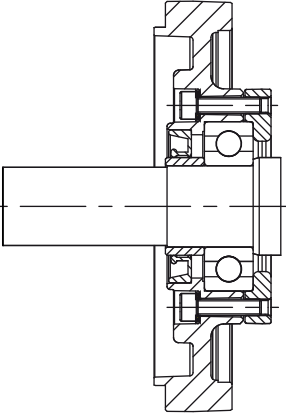
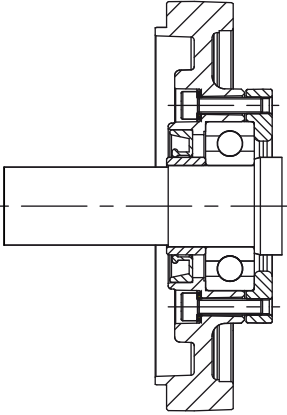
IP64	IP65	IP67
		
<p>Labyrinth seal It is not permissible that there is any moisture in the area around the shaft and the flange. Note: For IP 64 degree of protection it is not permissible that liquid collects in the flange.</p>	<p>Radial shaft sealing ring without annular spring Shaft outlet seal to protect against spray water and cooling-lubricating medium. It is permissible that the radial shaft sealing ring runs dry. Lifetime approx. 25000 h (nominal value). For IP65 degree of protection it is not permissible that liquid collects in the flange.</p>	<p>Radial shaft sealing ring For gearbox mounting (for gearboxes that are not sealed) to seal against oil. The sealing lip must be adequately cooled and lubricated by the gearbox oil in order to guarantee reliable function. Lifetime approx. 10000 h (nominal value). If a radial shaft sealing ring runs dry, then this has a strong negative impact on the functionality and the lifetime.</p>

3.4 Bearing version

The 1FT7 motors are equipped with greased-for-life deep-groove ball bearings. The location bearing is at the DE.

3.5 Radial and axial forces

3.5.1 Calculating the belt pre-tension

$$F_V \text{ [N]} = 2 \cdot M_0 \cdot c / d_R \qquad F_V \leq F_{R, \text{perm}}$$

Table 3- 12 Explanation of the formula abbreviations

Formula abbreviations	Unit	Description
F_V	N	Belt pre-tension
M_0	Nm	Motor static torque
c	—	Pre-tensioning factor: this factor is an empirical value provided by the belt manufacturer. It can be assumed to be as follows: for toothed belts: $c = 1.5$ to 2.2 for flat belts $c = 2.2$ to 3.0
d_R	m	Effective diameter of the belt pulley
$F_{R, \text{perm}}$	N	Permissible radial force

When using other configurations, the actual forces, generated from the torque being transferred, must be taken into account.

3.5.2 Radial force loading

Point of application of radial forces F_R at the shaft end

- for average operating speeds
- for a nominal bearing lifetime of 25,000 h

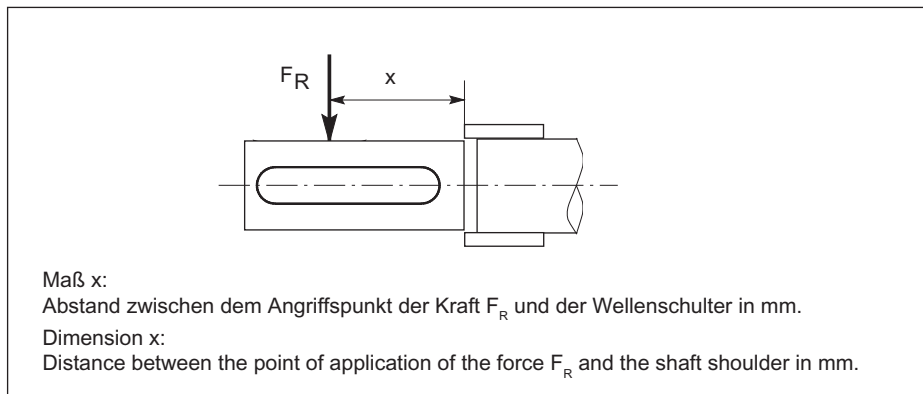

Figure 3-5 Force application point at the DE

Radial force 1FT7, SH 36

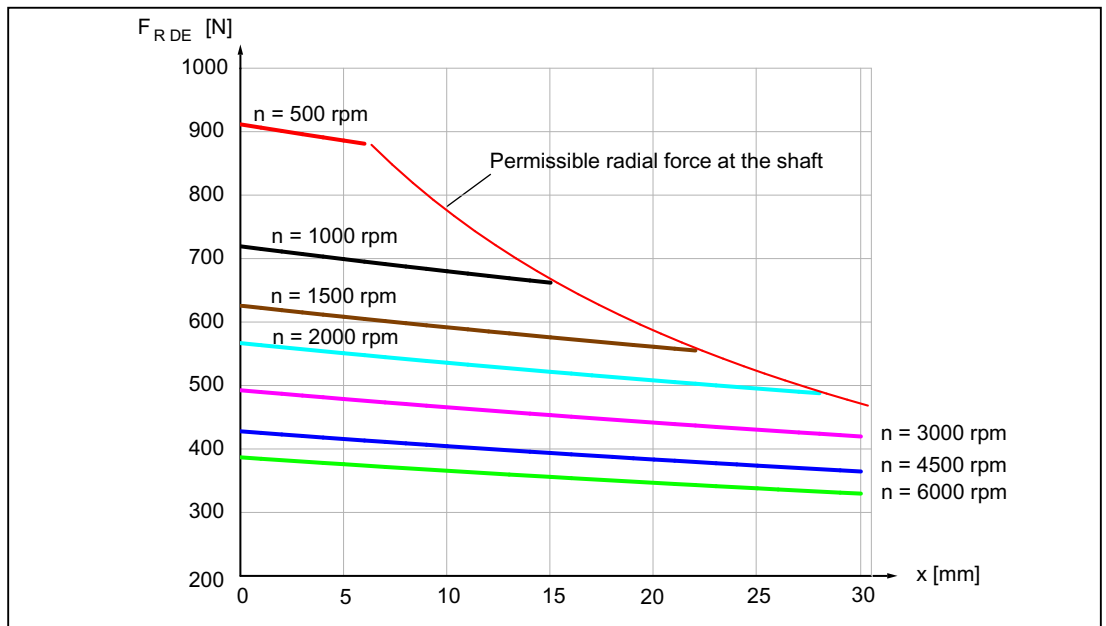

Figure 3-6 Radial force F_R at a distance x from the shaft shoulder for a statistical bearing lifetime of 25000 h

Radial force 1FT7, SH 48

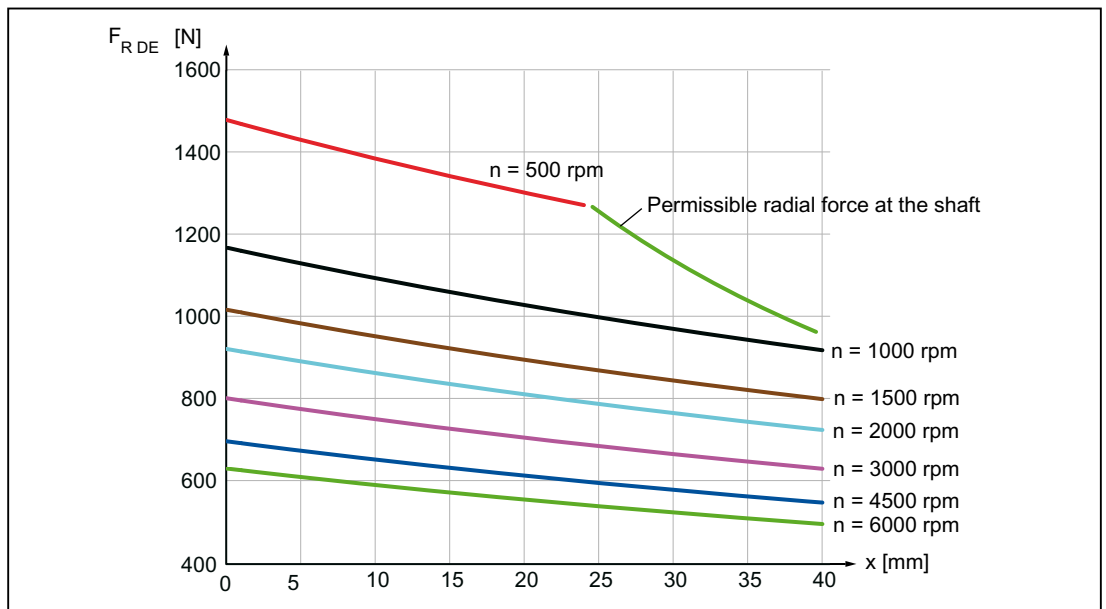

Figure 3-7 Radial force F_R at a distance x from the shaft shoulder for a statistical bearing lifetime of 25000 h

Radial force 1FT7, SH 63

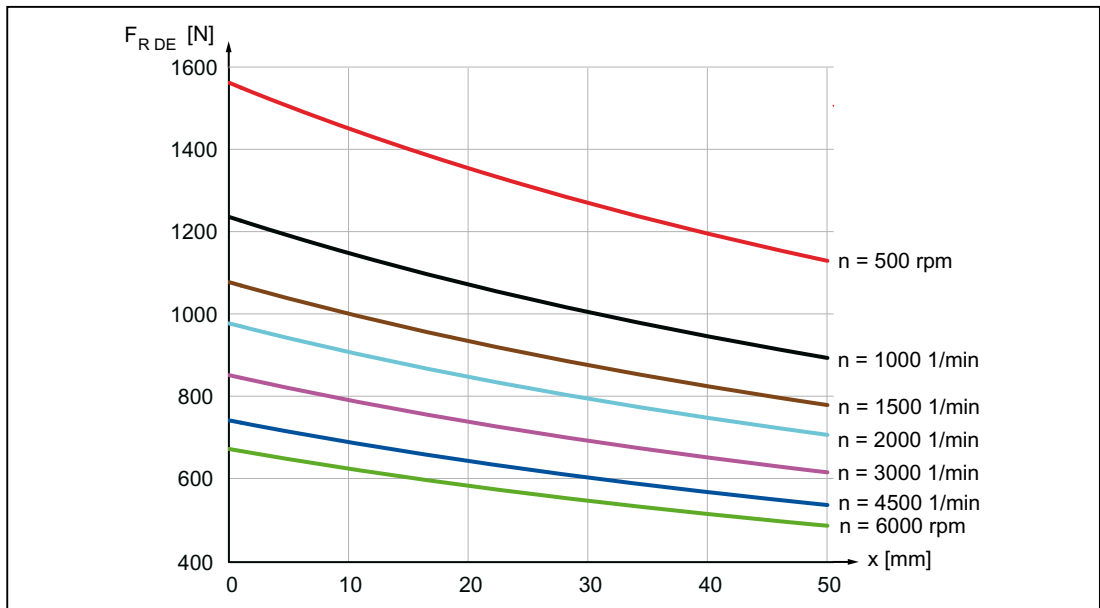

Figure 3-8 Radial force F_R at a distance x from the shaft shoulder for a statistical bearing lifetime of 25000 h

Radial force 1FT7, SH 80

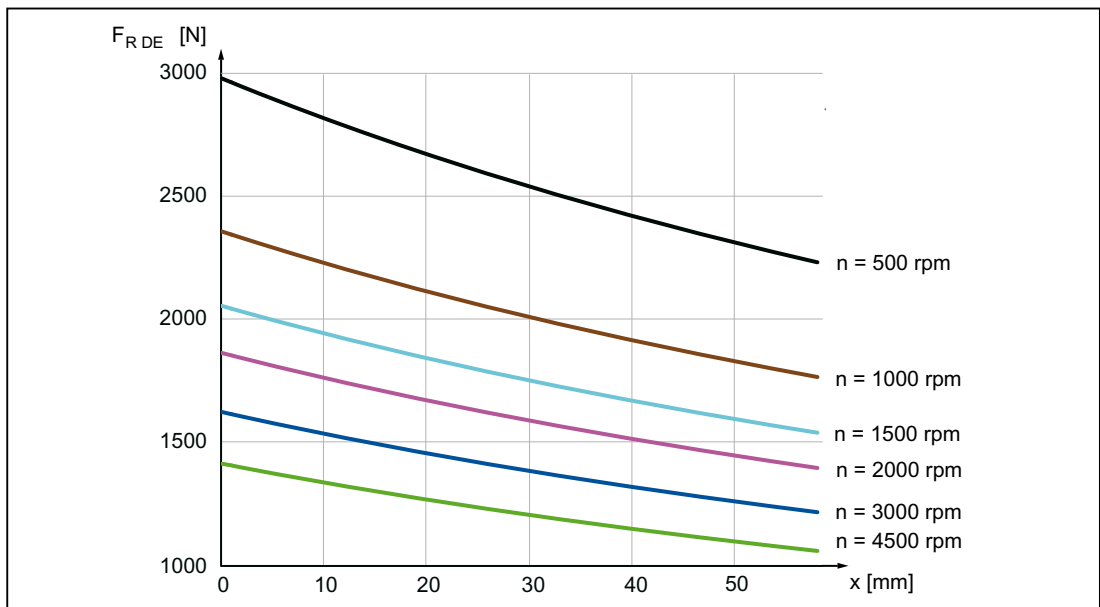

Figure 3-9 Radial force F_R at a distance x from the shaft shoulder for a statistical bearing lifetime of 25000 h

Radial force 1FT7, SH 100

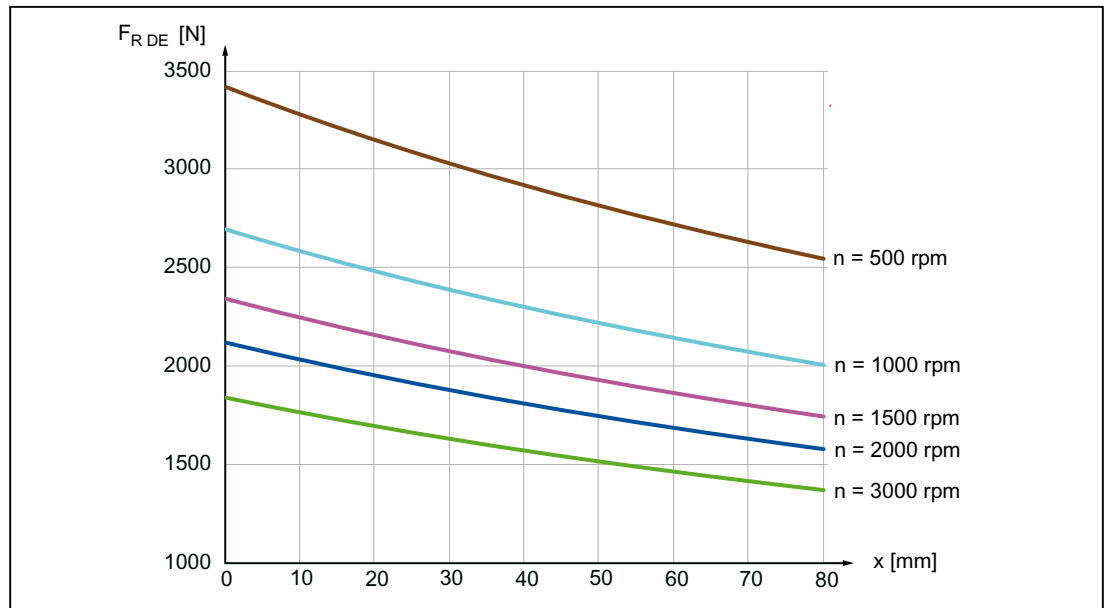

Figure 3-10 Radial force F_R at a distance x from the shaft shoulder for a statistical bearing lifetime of 25000 h

3.5.3 Axial force stressing

When using, for example, helical toothed wheels as the drive element, in addition to the radial force, there is also an axial force on the motor bearings. For axial forces, the spring-loading of the bearings can be overcome so that the rotor is displaced corresponding to the axial bearing play present.

Shaft height	Displacement
36 and 48	Approx. 0.2 mm
63 to 100	Approx. 0.35 mm

An axial force as large as the spring-loading is not permitted (100 ... 500 N). Premature failure is the result when the bearing is not pre-tensioned.

Calculating the permissible axial force: $F_A = F_R \cdot 0.35$

⚠ WARNING
Motors with integrated holding brake cannot be subject to axial forces!

3.6 Smooth running, concentricity and axial eccentricity

The shaft and flange accuracies are checked according to DIN 42955, IEC 60072-1. Any specifications deviating from these values are stated on the dimension drawings.

Table 3- 13 Radial eccentricity tolerance of the shaft to the frame axis (referred to cylindrical shaft ends)

Shaft height	Standard N	Option R
36	0.035 mm	0.018 mm
48, 63	0.04 mm	0.021 mm
80, 100	0.05 mm	0.025 mm

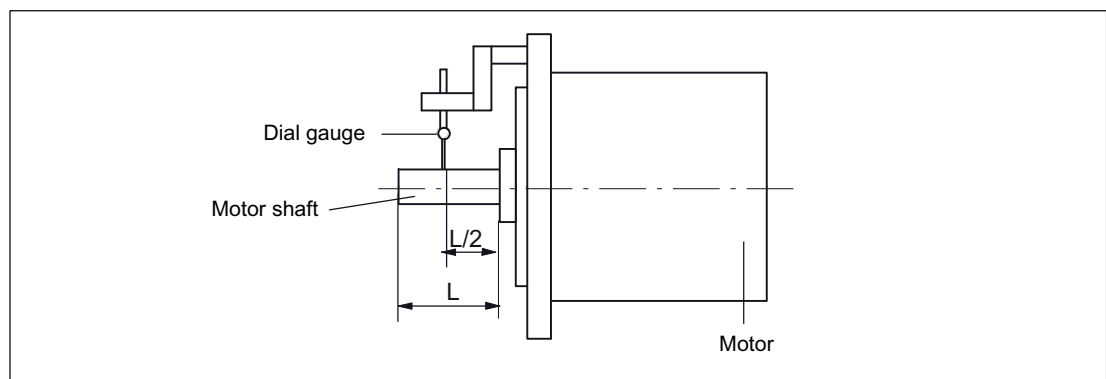

Figure 3-11 Checking the radial eccentricity

Table 3- 14 Concentricity and axial eccentricity tolerance of the flange surface to the shaft axis (referred to the centering diameter of the mounting flange)

Shaft height	Standard N	Option R
36, 48	0.08 mm	0.04 mm
63, 80, 100	0.1 mm	0.05 mm

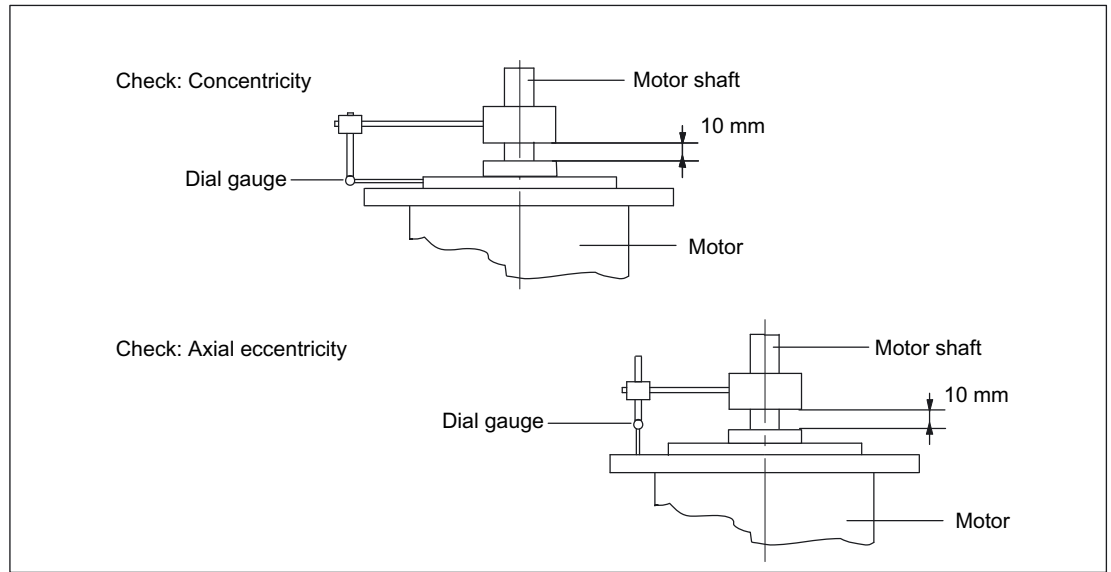

Figure 3-12 Checking the concentricity and axial eccentricity

3.7 Shaft end

The drive shaft end is cylindrical in accordance with DIN 748 Part 3, IEC 60072-1. The force-locked shaft-hub coupling is preferred for fast acceleration and reversing operation of the drives.

Standard: plain shaft

Option: keyway and key (half-key balancing)

3.8 Balancing

The motors are balanced according to DIN ISO 8821.

Motors with featherkey in the shaft are half-key balanced. The mass equalization for the protruding half key must be taken into account for the output elements.

3.9 Vibration severity grade

The 1FT7 motors conform to vibration magnitude Grade A in accordance with EN 60034-14 (IEC 60034-14).

The values indicated refer only to the motor. These values can be increased at the motor due to the overall vibration characteristics of the complete system after the drive has been mounted.

Compliance with the vibration magnitude grades up to rated speed (nN).

Standard: Vibration magnitude Grade A

Option: Vibration magnitude Grade R (compliance with vibration magnitude Grades A and R up to nN)

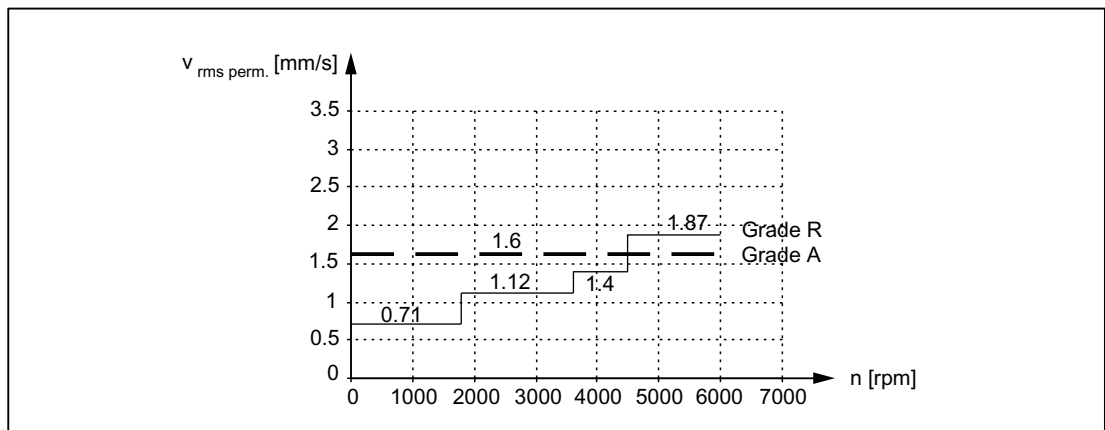

Figure 3-13 Characteristic curves of the vibration magnitude grades

3.10 Noise emission

When operated in the speed range 0 to rated speed, 1FT7 motors can reach the following measuring-surface sound pressure level $L_p(A)$:

Table 3- 15 Sound pressure level

Cooling method	Shaft height	Measuring-surface sound pressure level $L_p(A)$
Natural cooled	1FT703 to 1FT706	65 dB(A) + 3 dB tolerance
	1FT708 to 1FT710	70 dB(A) + 3 dB tolerance
Forced ventilation	1FT706 to 1FT710	73 dB(A) + 3 dB tolerance
Water cooled	1FT706	65 dB(A) + 3 dB tolerance
	1FT708 to 1FT710	70 dB(A) + 3 dB tolerance

The motors are certified for a wide range of installation and operating conditions. These conditions, such as rigid or vibration-isolated foundation design, influence noise emission, sometimes significantly.

3.11 Paint finish

If no special color is selected, the 1FT7 motors are painted in the standard color pearl dark grey (RAL 9023).

Table 3- 16 Order codes of special colors (option)

Designation	Order code
RAL 9005, jet black	X01
RAL 9001, cream	X02
RAL 6011, reseda green	X03
RAL 7032, pebble grey	X04
RAL 5015, sky blue	X05
RAL 1015, light ivory	X06
RAL 7016, anthracite grey	X09

Technical data and characteristics

4.1 Operating range and characteristics

Permissible operating range

The permissible operating range is limited by thermal, mechanical, and electromagnetic boundaries. The data in this documentation apply to the following temperatures:

- For naturally cooled motors: up to 40 °C ambient temperature
- For liquid-cooled motors: up to 30 °C coolant inlet temperature

The temperature rise of the motor is caused by the losses generated in the motor (current-dependent losses, no-load losses, friction losses). The utilization of the motor depends on the cooling method (naturally cooled, forced ventilation, liquid-cooled). To adhere to the temperature limits, the permissible torque decreases with increasing speed, starting from static torque M_0 .

Permissible temperature range, characteristics S1_(100 K) and S1_(60 K)

1FT7 motors can be operated up to an average winding temperature of 145 °C.

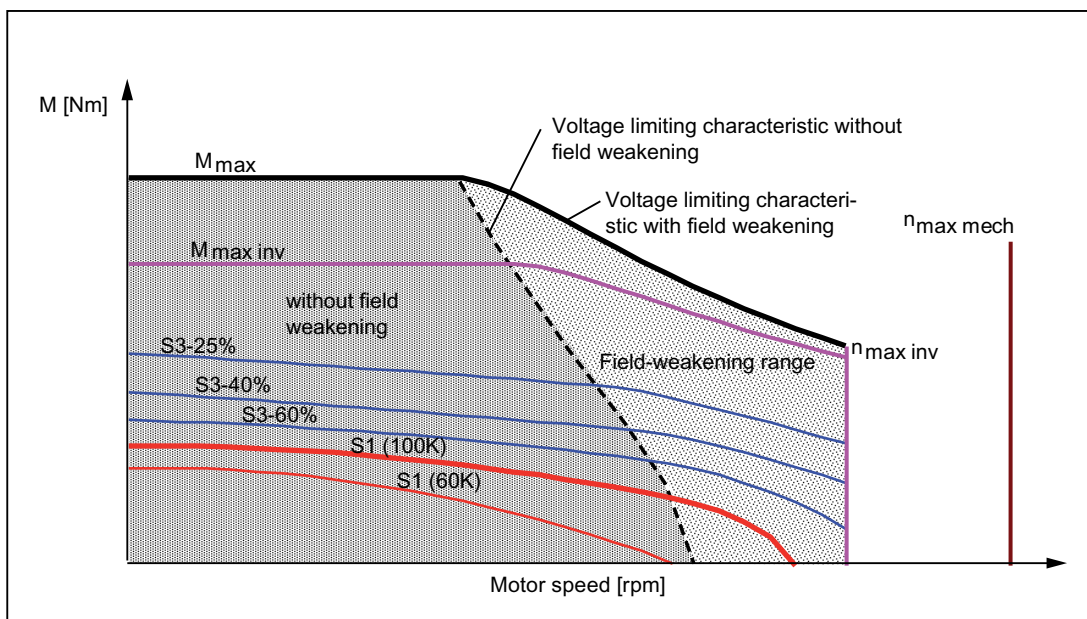



Figure 4-1 Torque characteristics of synchronous motors

For continuous operation, the limits of this permissible temperature range are represented by the S1 characteristic identified as 100 K. This corresponds to utilization according to temperature class 155 (F).

If a lower temperature class is necessary, for example

- If the temperature of the enclosure/housing must lie below 90° C for safety reasons
- If the motor temperature rise would have a negative impact on the machine

the S1 characteristic identified as 60 K can be chosen. In this case the motor conforms to temperature class 130 (B).

 CAUTION
Continuous duty above the S1 _(100 K) characteristic is not thermally permitted for the motor.

Periodic intermittent operation, characteristics $S3_{25\%/40\%/60\%}$ and M_{max}

In periodic intermittent operation the motor can be subjected to higher loading as a function of the ON period (see also chapter headed "Engineering"). The S3 characteristics identified with the respective ON period (25%, 40% and 60%) apply.

As a general rule the cycle time is 10 minutes. The overtemperature is 100 K.

As an exception, for small motors a cycle time of 1 minute is specified and noted in the characteristic curves. A transient, high overload capacity up to the characteristic M_{max} is provided over the complete speed setting range.

Recommended power unit

In the Chapter headed "Motor overview/assignment of power module" a power module is recommended for each 1FT7 motor in accordance with its stall current. The maximum achievable torque is shown in the characteristic $M_{max Inv}$.

When configuring intermittent or overload operation it must be checked whether a larger power module may be required in order to provide the necessary peak current.

Speed limits $n_{max mech}$ and $n_{max Inv}$

The speed range is limited by the mechanical limit speed $n_{max mech}$ (centrifugal forces at the rotor, bearing service life) or the electrical limit speed $n_{max Inv}$ (withstand voltage of the converter or max. frequency of the converter).

The maximum permissible speed n_{max} is therefore the minimum of $n_{max mech}$ and $n_{max Inv}$.

CAUTION

The maximum permissible speed (mechanical) $n_{max mech}$ must not be exceeded.

CAUTION

When the machine is running (with shaft operated by motor or separately driven) at speeds higher than $n_{max Inv}$, a voltage in excess of the maximum permissible converter voltage might be induced in the winding. This can cause irreparable damage to the converter. No operation is therefore permissible above the speed $n_{max Inv}$ without protective measures or other additional measures. Siemens AG accepts no liability for any damage occurring as a result of failure to pay heed to this danger warning.

Torque limit for operation on converter with field weakening option

With the SIMODRIVE converter system it is possible to activate the field weakening function. A field-weakening current is injected in such a way as to enable operation to the right of or above the voltage limiting characteristic. The limit characteristic for field weakening is determined by the winding version (armature circuit) and the magnitude of the converter output voltage. The characteristic curve is plotted for each winding version in a separate data sheet. The torque-speed diagrams for different converter output voltages are assigned to each data sheet:

Diagram	Converter output voltage V_{mot}	Power Module	Line voltage
Diagram [a]	380 V	SIMODRIVE 611 (UE)	400 V
Diagram [b]	425 V	SIMODRIVE 611 (ER)	400 V

When field weakening is used, the limiting characteristic drawn as a continuous line applies.

Torque limit for operation on converter without field weakening option

For the SIMODRIVE converter system, the field weakening function is deactivated as standard. This therefore reduces the operating range that is available.

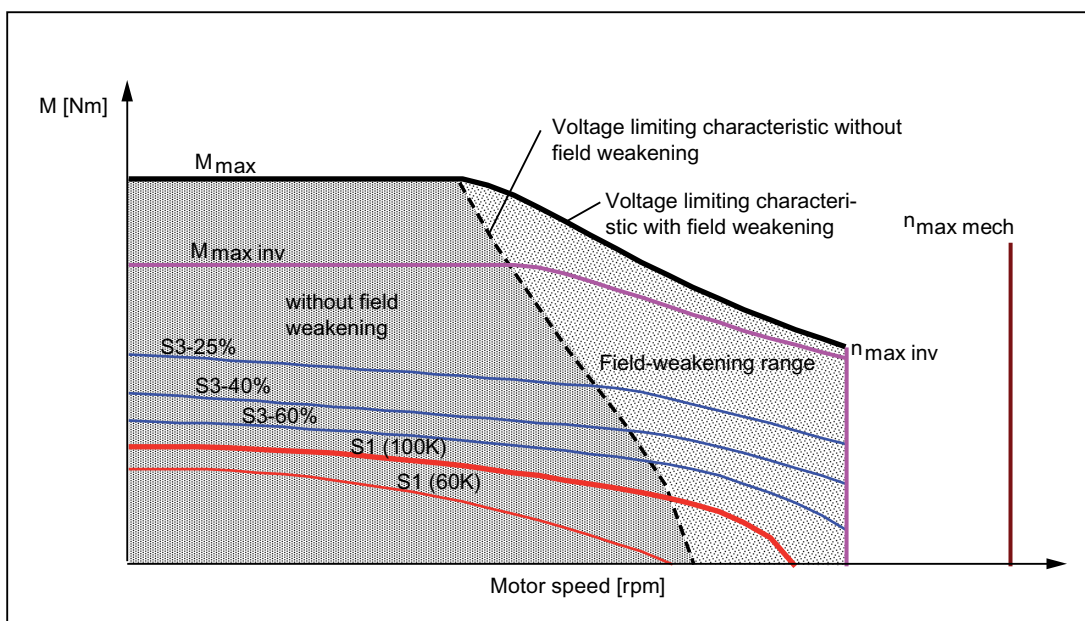

Figure 4-2 The shape of the voltage limiting characteristic curve is determined by the winding version (armature circuit) and the magnitude of the converter output voltage.

The voltage induced in the motor winding increases as the speed increases. The difference between the DC link voltage of the converter and the induced motor voltage can be used to apply the current.

This limits the magnitude of the current that can be impressed. This causes the torque to drop off quickly at high speeds. All operating points that can be achieved with the motor lie to the left of the voltage limiting characteristic curve shown as a dashed line.

The characteristic curve is plotted for each winding version in a separate data sheet. The torque-speed diagrams for different converter output voltages are assigned to each data sheet:

Diagram	Converter output voltage V_{mot}	Power Module	Line voltage
Diagram [a]	380 V	SIMODRIVE 611 (UE)	400 V
Diagram [b]	425 V	SIMODRIVE 611 (ER)	400 V

4.1 Operating range and characteristics

For different converter output voltages the voltage limiting characteristic curve must be shifted (offset) accordingly. See "Offset of the voltage limit characteristic" For 1FT7, the voltage limiting characteristic is calculated for a motor at operating temperature.

Winding versions

Several winding versions (armature circuits) for different rated speeds n_N are possible within a motor frame size.

Table 4- 1 Code letter, winding version

Rated speed n_N [1/min]	Winding version (10. position of the Order No.)
1500	B
2000	C
3000	F
4500	H
6000	K

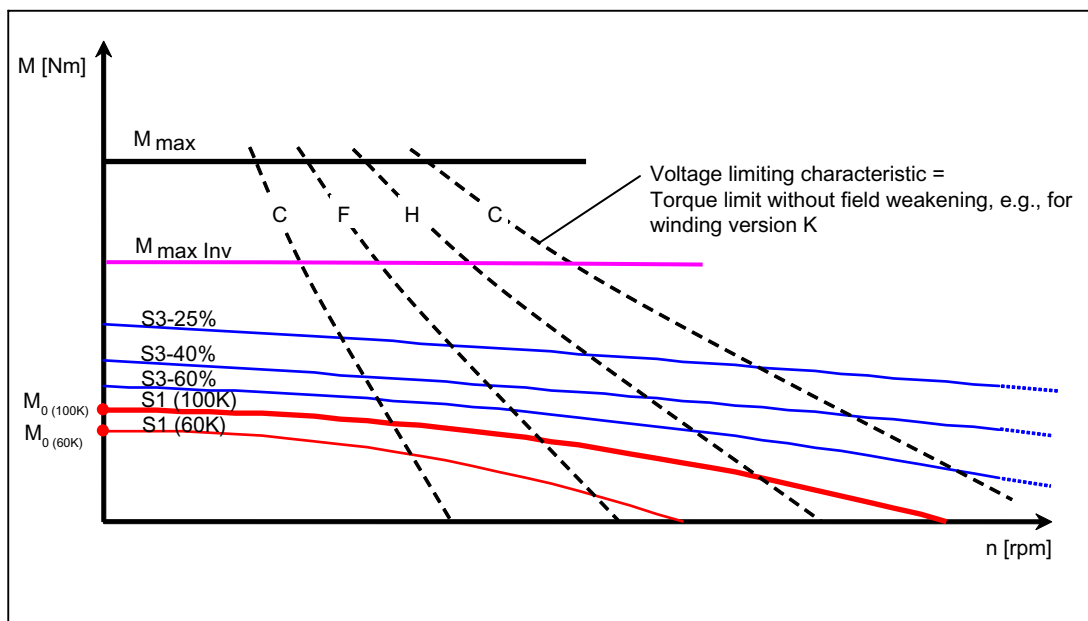

Figure 4-3 Speed-torque diagram

Note

The voltage limit characteristic of a motor with 6000 RPM rated speed lies far above that of the same motor type with 2000 RPM. However, for the same torque, this motor requires a significantly higher current.

For this reason, you should select the rated speed such that it does not lie too far above the maximum speed required for the application.

The size (rating) of the converter module (output current) can be minimized in this fashion

Shifting the voltage limiting characteristic curve (only relevant when field weakening is deactivated)

In order to identify the limits of the motor for a converter output voltage (V_{mot}) other than 380 V, 425 V, or 460 V, the relevant voltage limiting characteristic curve must be shifted (offset) for the particular new output voltage ($V_{\text{mot, new}}$).

NOTICE

The offset of the voltage limiting characteristic only applies to linear limiting characteristics, e.g. for the 1FT7 motors. The voltage limiting characteristic can be offset only if the condition $U_{\text{mot, new}} > U_{\text{iN}}$ is fulfilled.

Read the induced voltage U_{iN} from the motor rating plate or calculate it from the characteristic curve: $U_{\text{iN}} = k_E \cdot n_N / 1000$

The degree of offset is obtained as follows:

For an output voltage of $U_{\text{mot, new}}$, an offset is obtained along the X axis (speed) by a factor of:

$$\frac{U_{\text{mot, new}}}{U_{\text{Mot}}} \quad U_{\text{mot, new}} = \text{new converter output voltage}$$
$$\frac{U_{\text{mot, new}}}{U_{\text{Mot}}} \quad U_{\text{mot}} = \text{drive converter output voltage from the characteristic curve for 380 V, 425 V, or 460 V}$$

Calculating the new limit torque with the new limiting characteristic

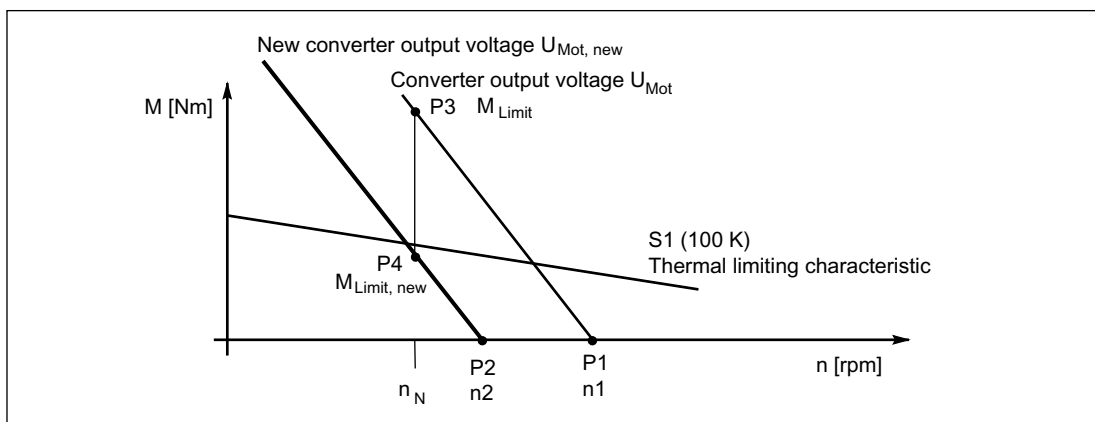

Figure 4-4 Offset of voltage limiting characteristic from U_{mot} to $U_{mot\ new}$

- P1 Intersection between voltage limiting characteristic and x axis: Read off or calculate the speed

$$n_1 \text{ [rpm]} = \frac{U_{Mot}}{k_E \cdot 0.95}$$

- P2 The point where the voltage limiting characteristic intersects with the x axis is shifted from n_1 to n_2 .

$$n_2 \text{ [rpm]} = n_1 \cdot \frac{U_{mot, new}}{U_{Mot}}$$

- P3 Read-off M_{limit} on the voltage limiting characteristic curve specified for V_{mot} .

- P4 Calculate $M_{limit, new}$

$$M_{limit, new} = \frac{U_{Mot, new} - U_{iN}}{U_{Mot} - U_{iN}} \cdot M_{limit}$$

The offset voltage limiting characteristic curve is obtained with points P2 and P4.

Example of offset of voltage limiting characteristic curve without field weakening

Motor 1FT7042-5AF71; $n_N = 3000$ rpm; $k_E = 87$ V/1000 rpm

$U_{mot\ new} = 290$ V; calculated with $U_{mot} = 380$ V (diagram [a])

$U_{iN} = k_E \cdot n_N/1000$; $U_{iN} = 87 \cdot 3000/1000 = 261$ V

Condition $U_{mot, new} > U_{iN}$ is fulfilled.

Calculation P1: $n_1 = \frac{380}{87 \cdot 0.95} \cdot 1000 \text{ rpm} = 4597 \text{ rpm}$

Calculation P2: $n_2 = \frac{290}{380} \cdot 4597 \text{ rpm} = 3508 \text{ rpm}$

Calculation P3: M_{Limit} for 300 V and $n_N = 3000 \text{ rpm}$ calculation = 8.8 Nm

Calculation P4: $M_{\text{Limit, new}} = \frac{290 - 261}{300 - 261} \cdot 8.8 \text{ Nm} = 2.14 \text{ Nm}$

Calculation P1: $n_1 = \frac{380}{87 \cdot 0.95} \cdot 1000 \text{ rpm} = 4597 \text{ rpm}$

Calculation P2: $n_2 = \frac{290}{380} \cdot 4597 \text{ rpm} = 3508 \text{ rpm}$

Calculation P3: M_{Limit} for 380 V and $n_N = 3000 \text{ rpm}$ calculation = 8.8

Calculation P4: $M_{\text{Limit, new}} = \frac{290 - 261}{380 - 261} \cdot 8.8 \text{ Nm} = 2.14 \text{ Nm}$

4.1 Operating range and characteristics

Enter and connect points P2 and P4. This line is the new voltage limiting characteristic for $U_{mot\ new} = 290\ V$.

Typical M/I characteristic

Because of saturation effects, the achievable torque cannot be calculated linearly from the current (particularly at high currents).

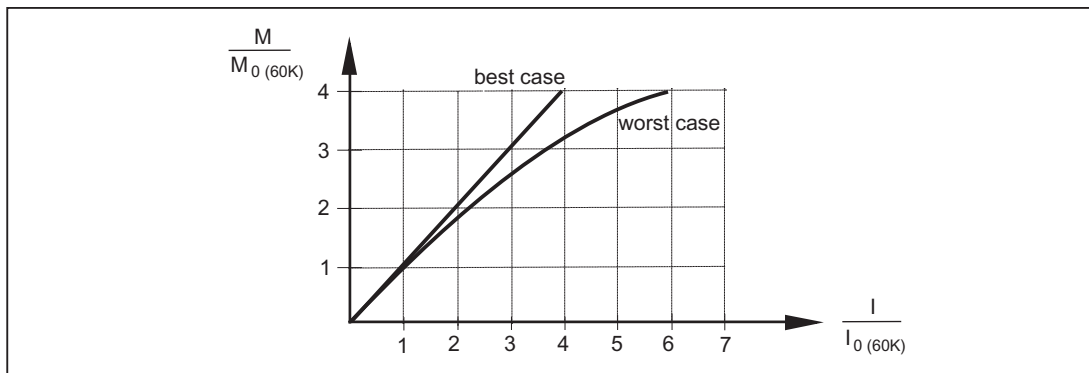

Figure 4-5 Torque-current characteristic curve for self-cooled motors

From M_0 (or I_0), the following formula can be used to determine the torque or the torque constant as a function of the current:

$$k_T(I) = \frac{M}{I} (I) = \frac{M_0}{I_0} + \frac{I - I_0}{I_{max} - I_0} \cdot \left(\frac{M_{max}}{I_{max}} - \frac{M_0}{I_0} \right)$$

Tolerance data

The data shown in the data sheets are nominal values that are subject to natural scatter. The following tolerances apply:

Table 4-2 Tolerance data in the motor list data

Motor list data		Typ. value	Guaranteed value
Stall current	I_0	$\pm 3\ %$	$\pm 7,5\ %$
Electrical time constant	T_{el}	$\pm 5\ %$	$\pm 10\ %$
Torque constant	k_T	$\pm 3\ %$	$\pm 7,5\ %$
Voltage constant	k_E	$\pm 3\ %$	$\pm 7,5\ %$
Winding resistance	R_{ph}	$\pm 5\ %$	$\pm 10\ %$
Moment of inertia	J_{mot}	$\pm 2\ %$	$\pm 10\ %$

Effects of the temperature influence and parameter scatter on the characteristic

The torque-speed characteristics specified in the following chapter relate to the nominal values at operating temperature (shown as characteristic 3 in the chart below).

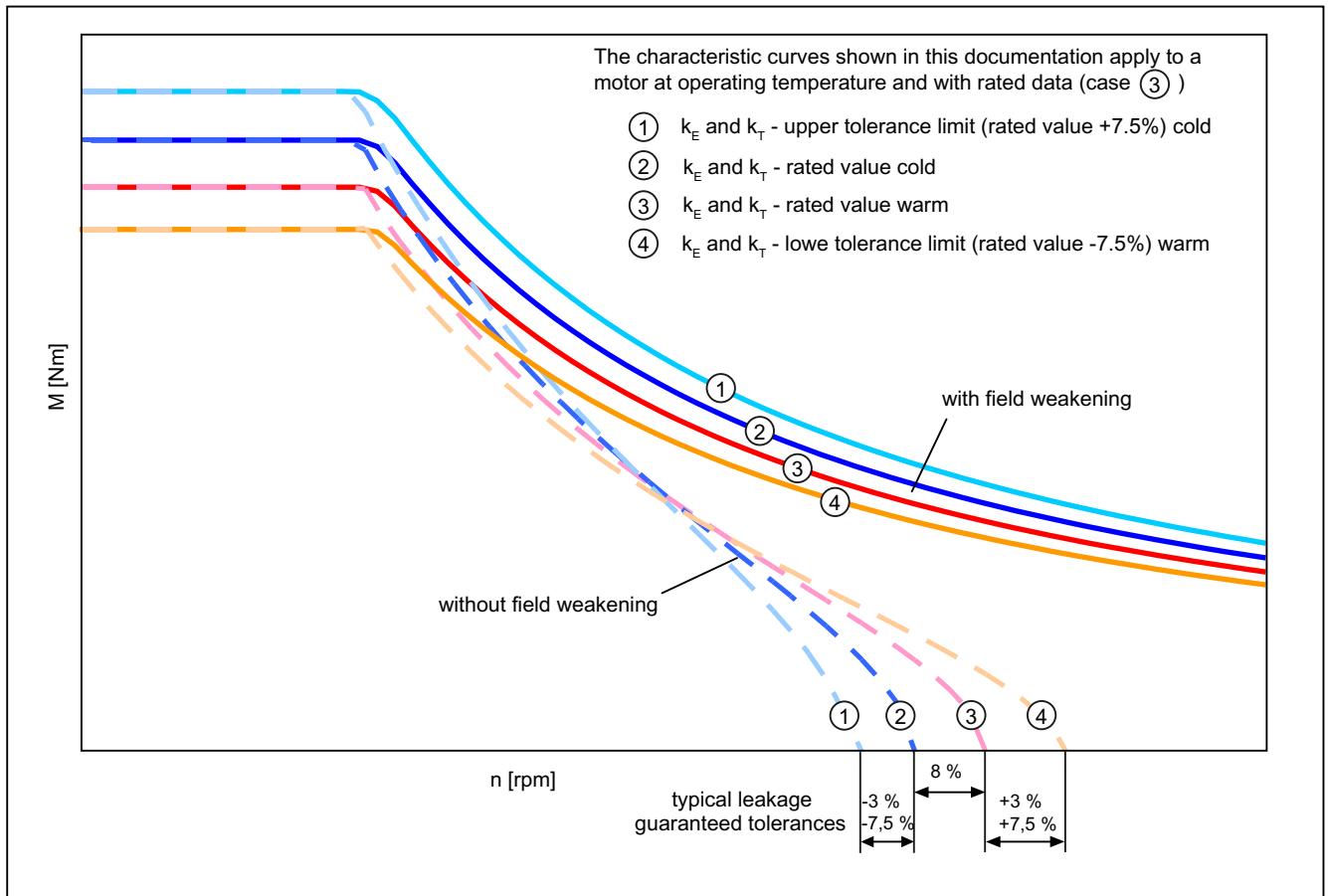

Figure 4-6 Effect of scatter

NOTICE

The motor temperature results in a clear displacement of the voltage limiting characteristic in the upper speed range. This must be taken into consideration during engineering (especially for applications in which the cold motor has to produce maximum speeds) with converter systems without field weakening.

4.2 Torque-speed characteristic

4.2.1 1FT7 synchronous motors, naturally cooled

Table 4- 3 1FT7034-□AK7

Technical data	Code	Unit	Value
Engineering data			
Rated speed	n_N	RPM	6000
Number of poles	2p	---	6
Rated torque (100 K)	$M_N (100\text{ K})$	Nm	1,4
Rated current (100 K)	$I_N (100\text{ K})$	A	2,1
Stall torque (60 K)	$M_0 (60\text{ K})$	Nm	1,6
Stall torque (100 K)	$M_0 (100\text{ K})$	Nm	2
Stall current (60 K)	$I_0 (60\text{ K})$	A	2,2
Stall current (100 K)	$I_0 (100\text{ K})$	A	2,7
Moment of inertia (with brake)	J_{MotBr}	10^{-4} kgm ²	0,98
Moment of inertia (without brake)	J_{mot}	10^{-4} kgm ²	0,85
Optimum operating point			
Optimum speed	n_{opt}	RPM	6000
Optimum power	P_{opt}	kW	0,88
Limit data			
Max. permissible speed (mech.)	$n_{max\ mech.}$	RPM	10000
Max. permissible speed (converter)	$n_{max\ conv}$	RPM	10000
Max. torque	M_{max}	Nm	8
Maximum current	I_{max}	A	12
Physical constants			
Torque constant	k_T	Nm/A	0,74
Voltage constant	k_E	V/1000 RPM	49
Winding resistance at 20° C	R_{ph}	Ω	2,4
Rotating field inductance	L_D	mH	9,7
Electrical time constant	T_{el}	ms	4,0
Mechanical time constant	T_{mech}	ms	1,1
Thermal time constant	T_{th}	min	25
Shaft torsional stiffness	C_t	Nm/rad	3700
Weight with brake	m_{MotBr}	kg	4,2
Weight without brake	m_{Mot}	kg	3,8

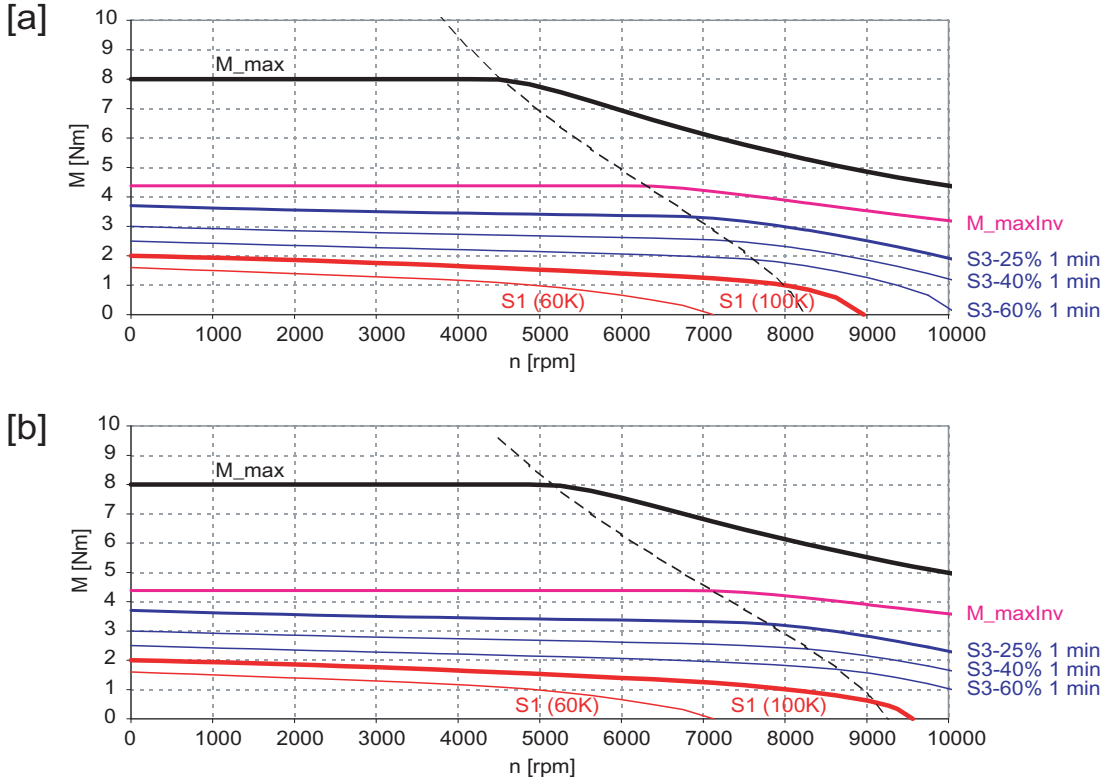

[a] SIMODRIVE 611 (UE), $V_{line} = 400 \text{ V}$, $V_{mot} = 380 \text{ V}_{rms}$

[b] SIMODRIVE 611 (ER), $V_{line} = 400 \text{ V}$, $V_{mot} = 425 \text{ V}_{rms}$

The characteristic curves are only valid for optimized converter setting data

Figure 4-7 1FT7034-□AK7

4.2 Torque-speed characteristic

Table 4- 4 1FT7036-□AK7

Technical data	Code	Unit	Value
Engineering data			
Rated speed	n_N	RPM	6000
Number of poles	2p	---	6
Rated torque (100 K)	$M_N (100\text{ K})$	Nm	1,7
Rated current (100 K)	$I_N (100\text{ K})$	A	2,4
Stall torque (60 K)	$M_0 (60\text{ K})$	Nm	2,4
Stall torque (100 K)	$M_0 (100\text{ K})$	Nm	3
Stall current (60 K)	$I_0 (60\text{ K})$	A	3,1
Stall current (100 K)	$I_0 (100\text{ K})$	A	4
Moment of inertia (with brake)	J_{MotBr}	10^{-4} kgm^2	1,45
Moment of inertia (without brake)	J_{mot}	10^{-4} kgm^2	1,33
Optimum operating point			
Optimum speed	n_{opt}	RPM	6000
Optimum power	P_{opt}	kW	1,07
Limit data			
Max. permissible speed (mech.)	$n_{max\ mech.}$	RPM	10000
Max. permissible speed (converter)	$n_{max\ conv}$	RPM	10000
Max. torque	M_{max}	Nm	12
Maximum current	I_{max}	A	17
Physical constants			
Torque constant	k_T	Nm/A	0,75
Voltage constant	k_E	V/1000 RPM	49
Winding resistance at 20° C	R_{ph}	Ω	1,4
Rotating field inductance	L_D	mH	5,9
Electrical time constant	T_{el}	ms	4,2
Mechanical time constant	T_{mech}	ms	1,0
Thermal time constant	T_{th}	min	30
Shaft torsional stiffness	C_t	Nm/rad	3100
Weight with brake	m_{MotBr}	kg	5,4
Weight without brake	m_{Mot}	kg	5

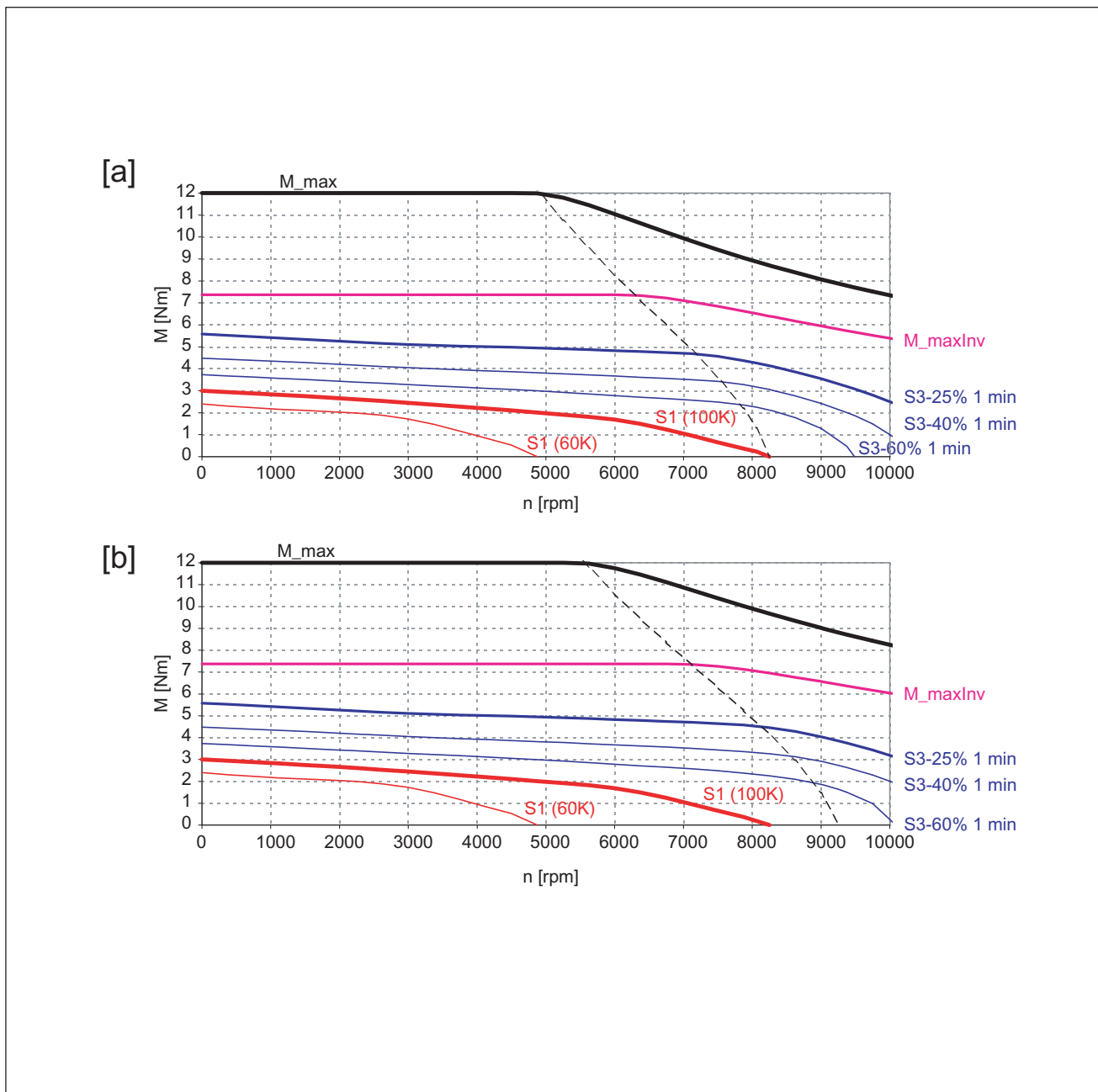

[a] SIMODRIVE 611 (UE), $V_{line} = 400$ V, $V_{mot} = 380$ V_{rms}

[b] SIMODRIVE 611 (ER), $V_{line} = 400$ V, $V_{mot} = 425$ V_{rms}

The characteristic curves are only valid for optimized converter setting data

Figure 4-8 1FT7036-□AK7

4.2 Torque-speed characteristic

Table 4- 5 1FT7042-□AF7

Technical data	Code	Unit	Value
Engineering data			
Rated speed	n_N	RPM	3000
Number of poles	2p	---	6
Rated torque (100 K)	$M_N (100\text{ K})$	Nm	2,7
Rated current (100 K)	$I_N (100\text{ K})$	A	2,1
Stall torque (60 K)	$M_0 (60\text{ K})$	Nm	2,5
Stall torque (100 K)	$M_0 (100\text{ K})$	Nm	3
Stall current (60 K)	$I_0 (60\text{ K})$	A	1,7
Stall current (100 K)	$I_0 (100\text{ K})$	A	2,1
Moment of inertia (with brake)	J_{MotBr}	10^{-4} kgm^2	3,68
Moment of inertia (without brake)	J_{mot}	10^{-4} kgm^2	2,81
Optimum operating point			
Optimum speed	n_{opt}	RPM	3000
Optimum power	P_{opt}	kW	0,85
Limit data			
Max. permissible speed (mech.)	$n_{max\ mech.}$	RPM	9000
Max. permissible speed (converter)	$n_{max\ conv}$	RPM	6600
Max. torque	M_{max}	Nm	13
Maximum current	I_{max}	A	11
Physical constants			
Torque constant	k_T	Nm/A	1,43
Voltage constant	k_E	V/1000 RPM	87
Winding resistance at 20° C	R_{ph}	Ω	3,5
Rotating field inductance	L_D	mH	21,4
Electrical time constant	T_{el}	ms	6
Mechanical time constant	T_{mech}	ms	1,4
Thermal time constant	T_{th}	min	20
Shaft torsional stiffness	C_t	Nm/rad	11700
Weight with brake	m_{MotBr}	kg	5,5
Weight without brake	m_{Mot}	kg	4,6

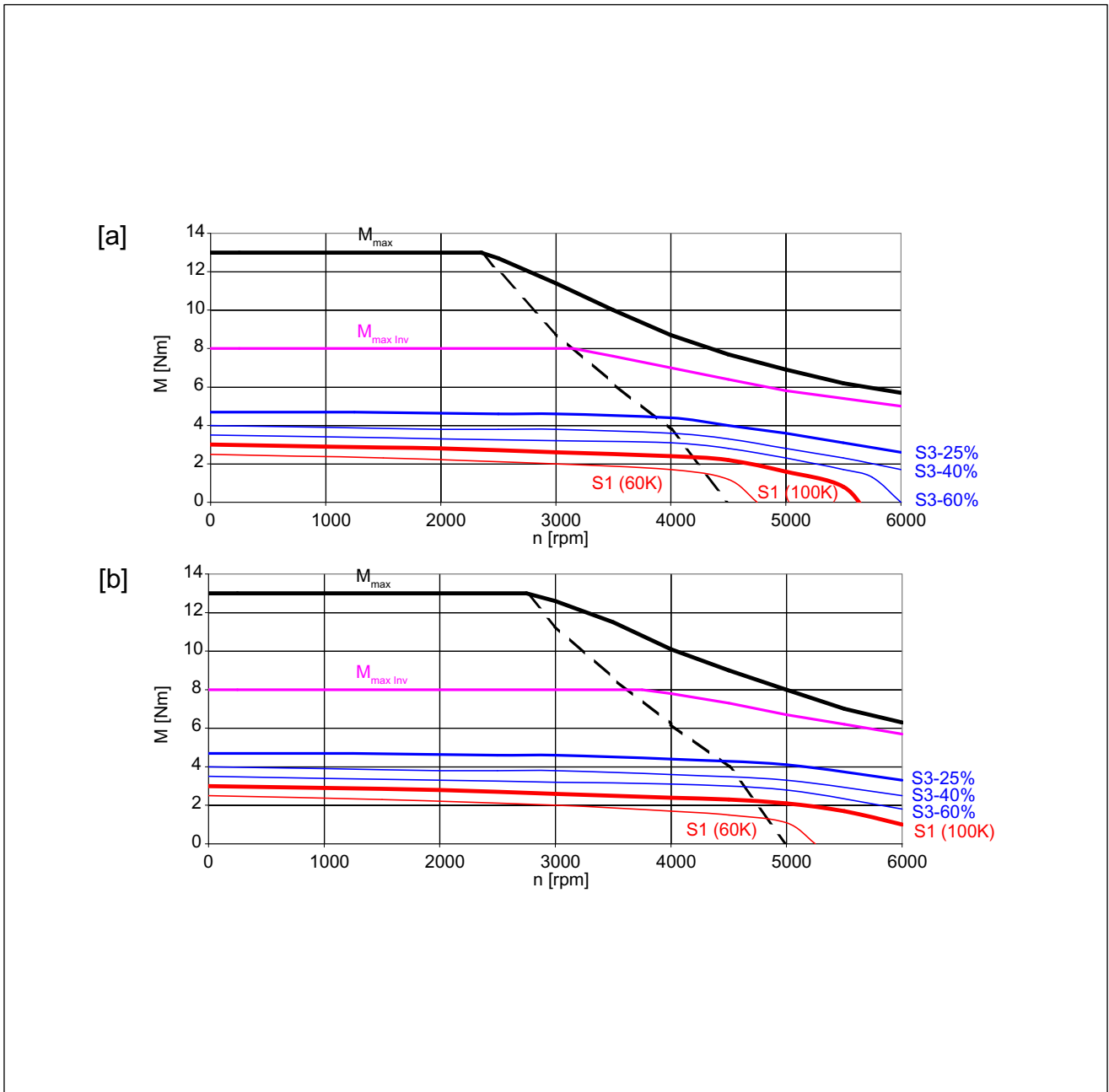

[a] SIMODRIVE 611 (UE), $V_{line} = 400$ V, $V_{mot} = 380$ V_{rms}

[b] SIMODRIVE 611 (ER), $V_{line} = 400$ V, $V_{mot} = 425$ V_{rms}

The characteristic curves are only valid for optimized converter setting data

Figure 4-9 1FT7042-□AF7

4.2 Torque-speed characteristic

Table 4- 6 1FT7042-□AK7

Technical data	Code	Unit	Value
Engineering data			
Rated speed	n_N	RPM	6000
Number of poles	2p	---	6
Rated torque (100 K)	$M_N (100 K)$	Nm	2
Rated current (100 K)	$I_N (100 K)$	A	3
Stall torque (60 K)	$M_0 (60 K)$	Nm	2,4
Stall torque (100 K)	$M_0 (100 K)$	Nm	3
Stall current (60 K)	$I_0 (60 K)$	A	3,1
Stall current (100 K)	$I_0 (100 K)$	A	3,9
Moment of inertia (with brake)	J_{MotBr}	10^{-4} kgm^2	3,68
Moment of inertia (without brake)	J_{mot}	10^{-4} kgm^2	2,81
Optimum operating point			
Optimum speed	n_{opt}	RPM	6000
Optimum power	P_{opt}	kW	1,26
Limit data			
Max. permissible speed (mech.)	$n_{max \text{ mech.}}$	RPM	9000
Max. permissible speed (converter)	$n_{max \text{ conv}}$	RPM	9000
Max. torque	M_{max}	Nm	13
Maximum current	I_{max}	A	21
Physical constants			
Torque constant	k_T	Nm/A	0,77
Voltage constant	k_E	V/1000 RPM	49
Winding resistance at 20° C	R_{ph}	Ω	1,12
Rotating field inductance	L_D	mH	6,5
Electrical time constant	T_{el}	ms	6
Mechanical time constant	T_{mech}	ms	1,6
Thermal time constant	T_{th}	min	20
Shaft torsional stiffness	C_t	Nm/rad	11700
Weight with brake	m_{MotBr}	kg	5,5
Weight without brake	m_{Mot}	kg	4,6

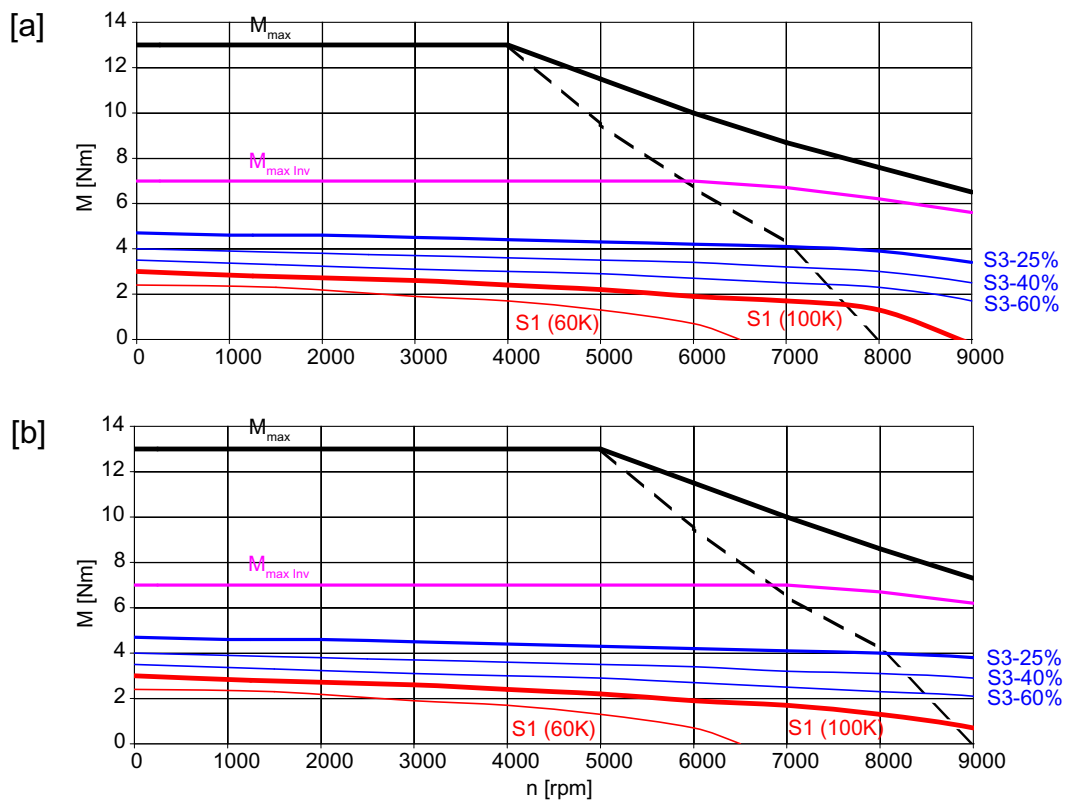

[a] SIMODRIVE 611 (UE), $V_{\text{line}} = 400$ V, $V_{\text{mot}} = 380$ V_{rms}

[b] SIMODRIVE 611 (ER), $V_{\text{line}} = 400$ V, $V_{\text{mot}} = 425$ V_{rms}

The characteristic curves are only valid for optimized converter setting data

Figure 4-10 1FT7042-□AK7

4.2 Torque-speed characteristic

Table 4- 7 1FT7044-□AF7

Technical data	Code	Unit	Value
Engineering data			
Rated speed	n_N	RPM	3000
Number of poles	2p	---	6
Rated torque (100 K)	$M_N (100\text{ K})$	Nm	4,3
Rated current (100 K)	$I_N (100\text{ K})$	A	2,6
Stall torque (60 K)	$M_0 (60\text{ K})$	Nm	4,4
Stall torque (100 K)	$M_0 (100\text{ K})$	Nm	5
Stall current (60 K)	$I_0 (60\text{ K})$	A	2,5
Stall current (100 K)	$I_0 (100\text{ K})$	A	2,8
Moment of inertia (with brake)	J_{MotBr}	10^{-4} kgm^2	6,3
Moment of inertia (without brake)	J_{mot}	10^{-4} kgm^2	5,43
Optimum operating point			
Optimum speed	n_{opt}	RPM	3000
Optimum power	P_{opt}	kW	1,35
Limit data			
Max. permissible speed (mech.)	$n_{max\ mech.}$	RPM	9000
Max. permissible speed (converter)	$n_{max\ conv}$	RPM	5200
Max. torque	M_{max}	Nm	23
Maximum current	I_{max}	A	16
Physical constants			
Torque constant	k_T	Nm/A	1,79
Voltage constant	k_E	V/1000 RPM	111
Winding resistance at 20° C	R_{ph}	Ω	2,3
Rotating field inductance	L_D	mH	15
Electrical time constant	T_{el}	ms	7
Mechanical time constant	T_{mech}	ms	1,2
Thermal time constant	T_{th}	min	35
Shaft torsional stiffness	C_t	Nm/rad	9500
Weight with brake	m_{MotBr}	kg	8,1
Weight without brake	m_{Mot}	kg	7,2

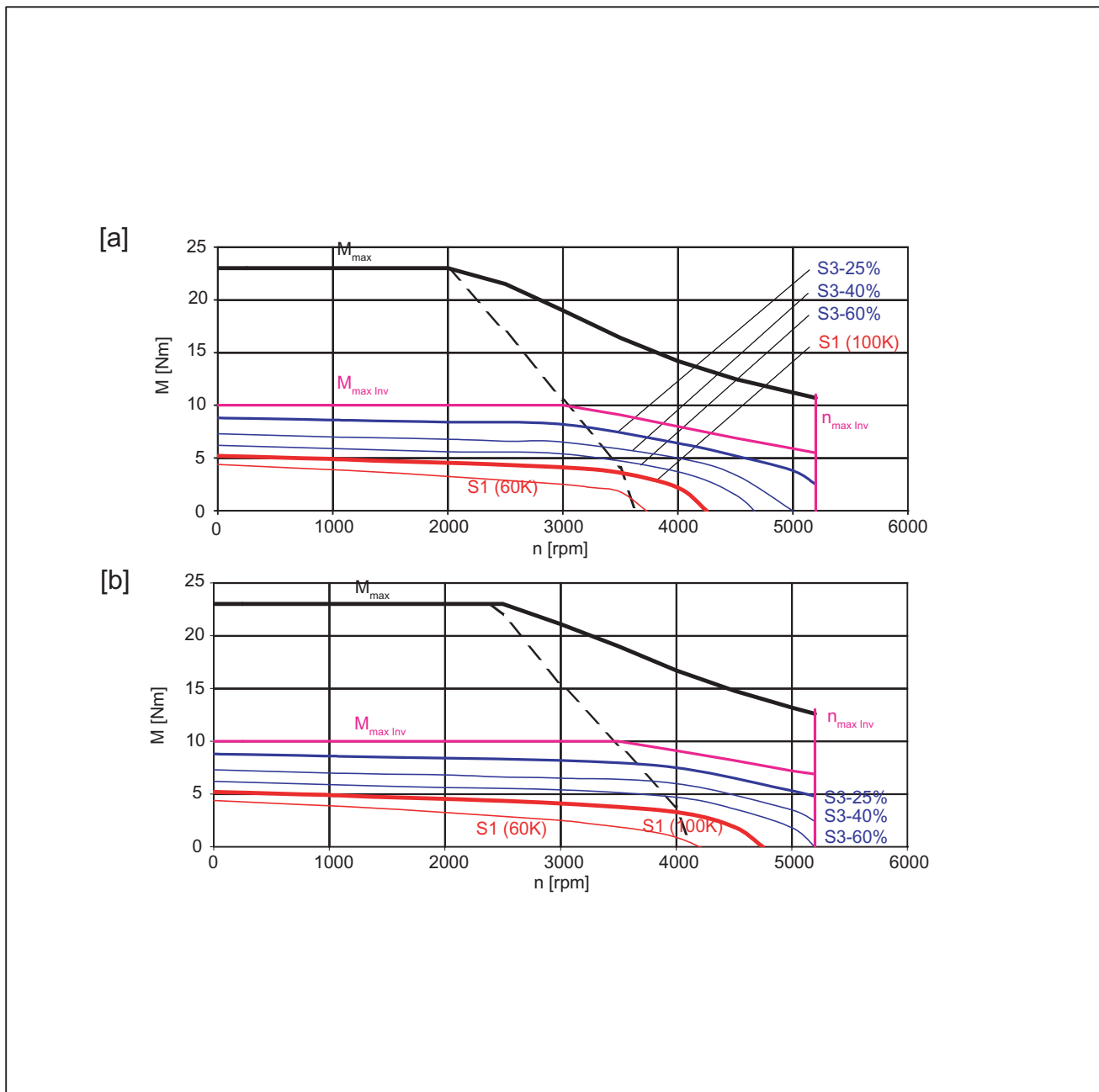

[a] SIMODRIVE 611 (UE), $V_{line} = 400\text{ V}$, $V_{mot} = 380\text{ V}_{rms}$

[b] SIMODRIVE 611 (ER), $V_{line} = 400\text{ V}$, $V_{mot} = 425\text{ V}_{rms}$

The characteristic curves are only valid for optimized converter setting data

Figure 4-11 1FT7044-□AF7

4.2 Torque-speed characteristic

Table 4- 8 1FT7044-□AK7

Technical data	Code	Unit	Value
Engineering data			
Rated speed	n_N	RPM	6000
Number of poles	2p	---	6
Rated torque (100 K)	$M_N (100\text{ K})$	Nm	2
Rated current (100 K)	$I_N (100\text{ K})$	A	2,5
Stall torque (60 K)	$M_0 (60\text{ K})$	Nm	4,4
Stall torque (100 K)	$M_0 (100\text{ K})$	Nm	5
Stall current (60 K)	$I_0 (60\text{ K})$	A	4,8
Stall current (100 K)	$I_0 (100\text{ K})$	A	5,7
Moment of inertia (with brake)	J_{MotBr}	10^{-4} kgm^2	6,3
Moment of inertia (without brake)	J_{mot}	10^{-4} kgm^2	5,43
Optimum operating point			
Optimum speed	n_{opt}	RPM	4500
Optimum power	P_{opt}	kW	1,41
Limit data			
Max. permissible speed (mech.)	$n_{max\ mech.}$	RPM	9000
Max. permissible speed (converter)	$n_{max\ conv}$	RPM	9000
Max. torque	M_{max}	Nm	23
Maximum current	I_{max}	A	30
Physical constants			
Torque constant	k_T	Nm/A	0,88
Voltage constant	k_E	V/1000 RPM	57
Winding resistance at 20° C	R_{ph}	Ω	0,61
Rotating field inductance	L_D	mH	4,2
Electrical time constant	T_{el}	ms	7
Mechanical time constant	T_{mech}	ms	1,3
Thermal time constant	T_{th}	min	35
Shaft torsional stiffness	C_t	Nm/rad	9500
Weight with brake	m_{MotBr}	kg	8,1
Weight without brake	m_{Mot}	kg	7,2

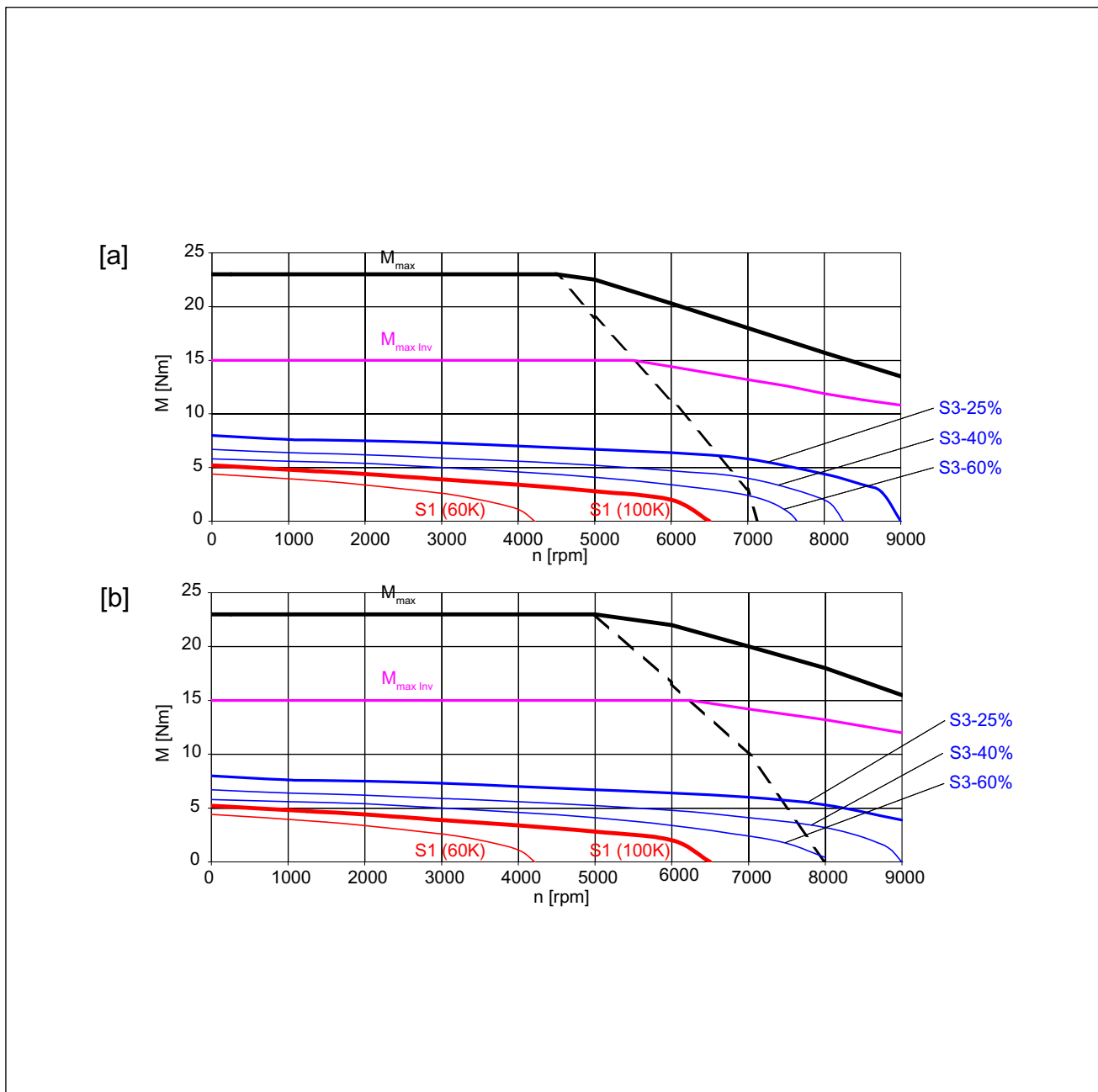

[a] SIMODRIVE 611 (UE), $V_{line} = 400 \text{ V}$, $V_{mot} = 380 \text{ V}_{rms}$

[b] SIMODRIVE 611 (ER), $V_{line} = 400 \text{ V}$, $V_{mot} = 425 \text{ V}_{rms}$

The characteristic curves are only valid for optimized converter setting data

Figure 4-12 1FT7044-□AK7

4.2 Torque-speed characteristic

Table 4- 9 1FT7046-□AF7

Technical data	Code	Unit	Value
Engineering data			
Rated speed	n_N	RPM	3000
Number of poles	2p	---	6
Rated torque (100 K)	$M_N (100 K)$	Nm	5,6
Rated current (100 K)	$I_N (100 K)$	A	3,5
Stall torque (60 K)	$M_0 (60 K)$	Nm	6
Stall torque (100 K)	$M_0 (100 K)$	Nm	7
Stall current (60 K)	$I_0 (60 K)$	A	3,3
Stall current (100 K)	$I_0 (100 K)$	A	4
Moment of inertia (with brake)	J_{MotBr}	10^{-4} kgm^2	8,39
Moment of inertia (without brake)	J_{mot}	10^{-4} kgm^2	7,52
Optimum operating point			
Optimum speed	n_{opt}	RPM	3000
Optimum power	P_{opt}	kW	1,76
Limit data			
Max. permissible speed (mech.)	$n_{max \text{ mech.}}$	RPM	9000
Max. permissible speed (converter)	$n_{max \text{ conv}}$	RPM	5200
Max. torque	M_{max}	Nm	31
Maximum current	I_{max}	A	19
Physical constants			
Torque constant	k_T	Nm/A	1,75
Voltage constant	k_E	V/1000 RPM	111
Winding resistance at 20° C	R_{ph}	Ω	1,55
Rotating field inductance	L_D	mH	11
Electrical time constant	T_{el}	ms	7
Mechanical time constant	T_{mech}	ms	1,1
Thermal time constant	T_{th}	min	35
Shaft torsional stiffness	C_t	Nm/rad	8200
Weight with brake	m_{MotBr}	kg	10,2
Weight without brake	m_{Mot}	kg	9,3

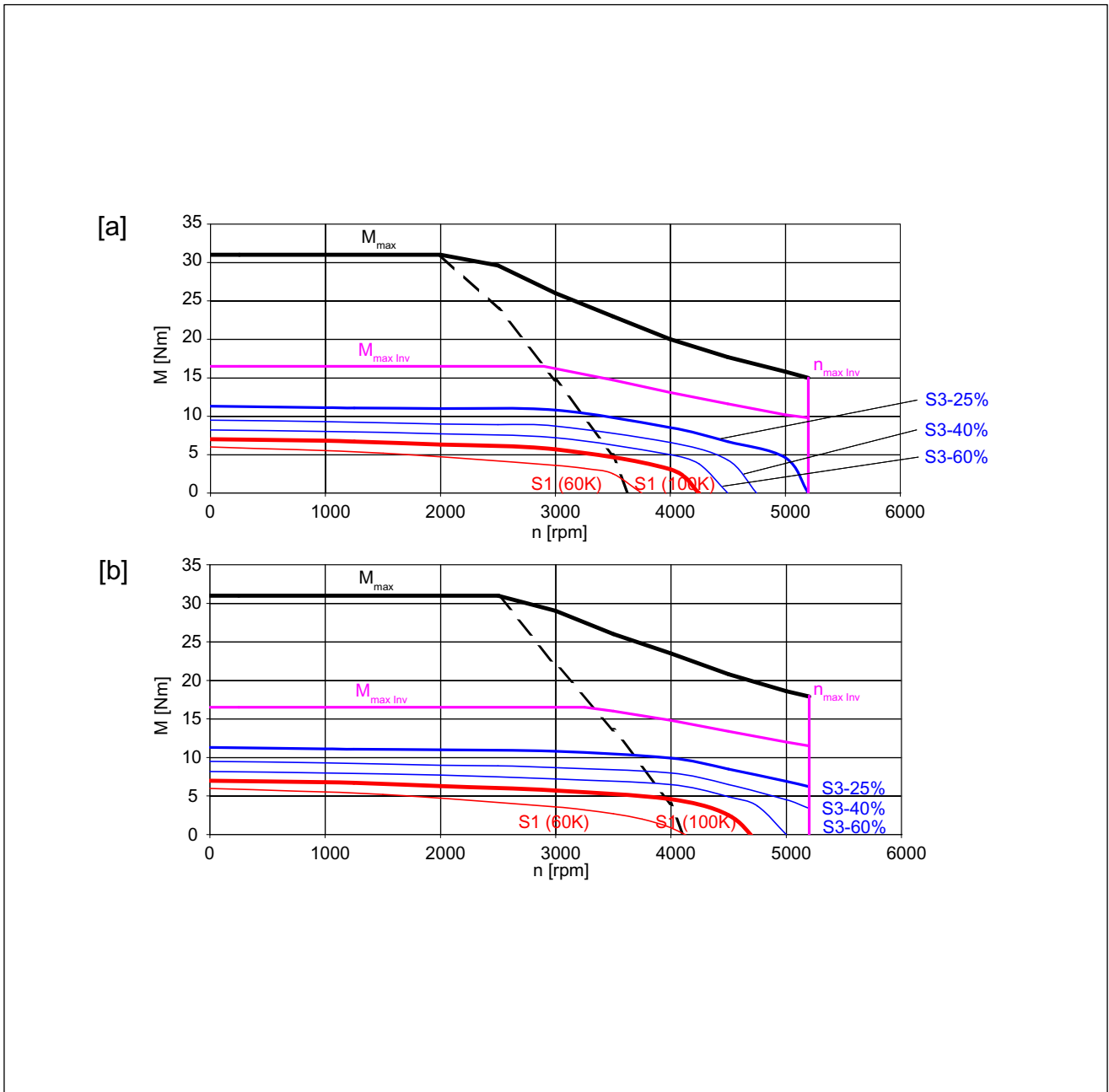

[a] SIMODRIVE 611 (UE), $V_{line} = 400 V$, $V_{mot} = 380 V_{rms}$

[b] SIMODRIVE 611 (ER), $V_{line} = 400 V$, $V_{mot} = 425 V_{rms}$

The characteristic curves are only valid for optimized converter setting data

Figure 4-13 1FT7046-□AF7

4.2 Torque-speed characteristic

Table 4- 10 1FT7046-□AH7

Technical data	Code	Unit	Value
Engineering data			
Rated speed	n_N	RPM	4500
Number of poles	2p	---	6
Rated torque (100 K)	$M_N (100\text{ K})$	Nm	2,4
Rated current (100 K)	$I_N (100\text{ K})$	A	3,2
Stall torque (60 K)	$M_0 (60\text{ K})$	Nm	6
Stall torque (100 K)	$M_0 (100\text{ K})$	Nm	7
Stall current (60 K)	$I_0 (60\text{ K})$	A	6,7
Stall current (100 K)	$I_0 (100\text{ K})$	A	8,1
Moment of inertia (with brake)	J_{MotBr}	10^{-4} kgm^2	8,39
Moment of inertia (without brake)	J_{mot}	10^{-4} kgm^2	7,52
Optimum operating point			
Optimum speed	n_{opt}	RPM	3500
Optimum power	P_{opt}	kW	1,32
Limit data			
Max. permissible speed (mech.)	$n_{max\ mech.}$	RPM	9000
Max. permissible speed (converter)	$n_{max\ conv}$	RPM	9000
Max. torque	M_{max}	Nm	31
Maximum current	I_{max}	A	38
Physical constants			
Torque constant	k_T	Nm/A	0,86
Voltage constant	k_E	V/1000 RPM	57
Winding resistance at 20° C	R_{ph}	Ω	0,42
Rotating field inductance	L_D	mH	2,9
Electrical time constant	T_{el}	ms	7
Mechanical time constant	T_{mech}	ms	1,3
Thermal time constant	T_{th}	min	35
Shaft torsional stiffness	C_t	Nm/rad	8200
Weight with brake	m_{MotBr}	kg	10,2
Weight without brake	m_{Mot}	kg	9,3

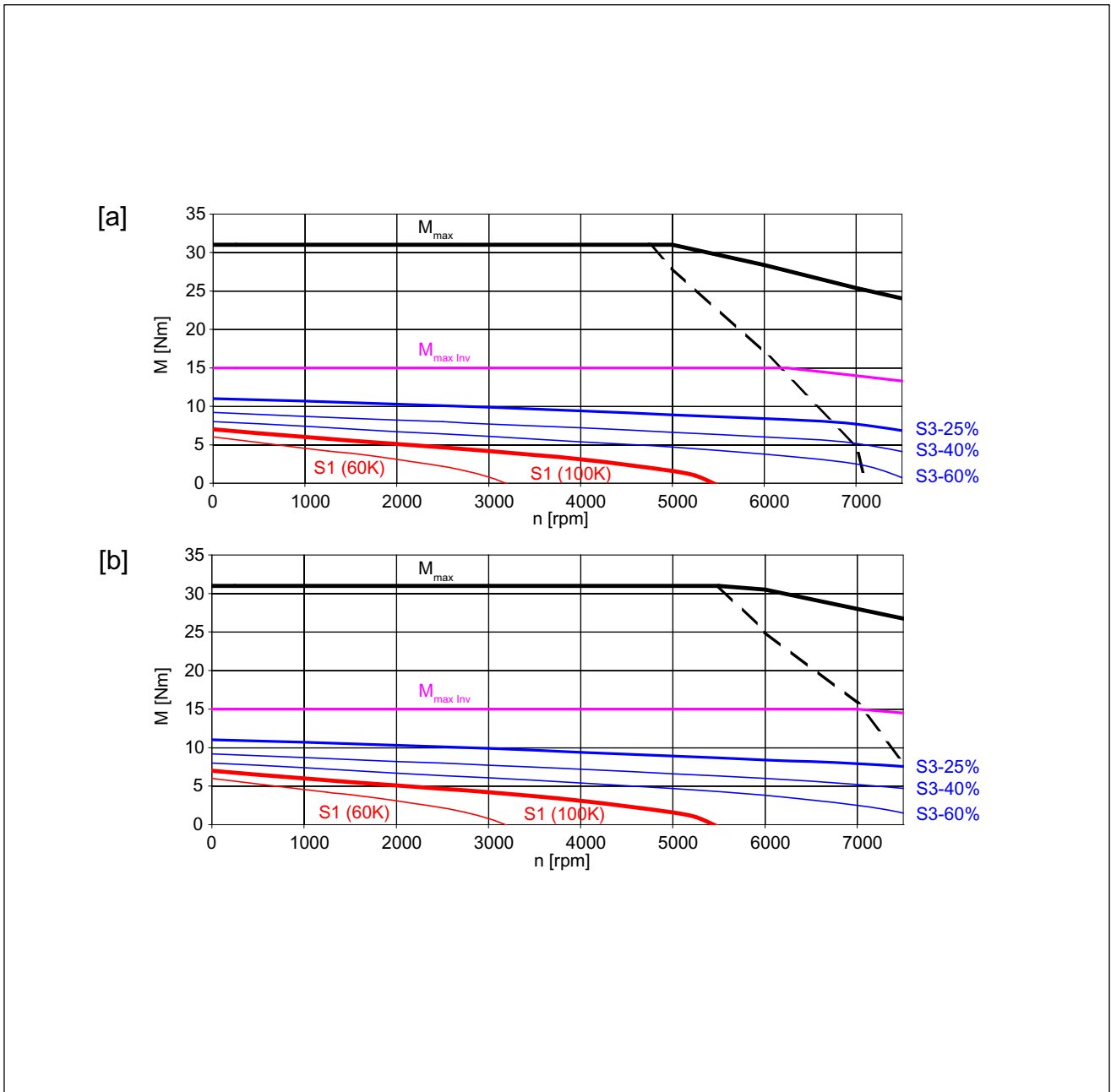

[a] SIMODRIVE 611 (UE), $V_{line} = 400 \text{ V}$, $V_{mot} = 380 \text{ V}_{rms}$

[b] SIMODRIVE 611 (ER), $V_{line} = 400 \text{ V}$, $V_{mot} = 425 \text{ V}_{rms}$

The characteristic curves are only valid for optimized converter setting data

Figure 4-14 1FT7046-□AH7

4.2 Torque-speed characteristic

Table 4- 11 1FT7062-□AF7

Technical data	Code	Unit	Value
Engineering data			
Rated speed	n_N	RPM	3000
Number of poles	2p	---	10
Rated torque (100 K)	$M_N (100\text{ K})$	Nm	5,4
Rated current (100 K)	$I_N (100\text{ K})$	A	3,9
Stall torque (60 K)	$M_0 (60\text{ K})$	Nm	5
Stall torque (100 K)	$M_0 (100\text{ K})$	Nm	6
Stall current (60 K)	$I_0 (60\text{ K})$	A	3,2
Stall current (100 K)	$I_0 (100\text{ K})$	A	3,9
Moment of inertia (with brake)	J_{MotBr}	10^{-4} kgm^2	10,2
Moment of inertia (without brake)	J_{mot}	10^{-4} kgm^2	7,36
Optimum operating point			
Optimum speed	n_{opt}	RPM	3000
Optimum power	P_{opt}	kW	1,70
Limit data			
Max. permissible speed (mech.)	$n_{max\ mech.}$	RPM	9000
Max. permissible speed (converter)	$n_{max\ conv}$	RPM	6100
Max. torque	M_{max}	Nm	24
Maximum current	I_{max}	A	22
Physical constants			
Torque constant	k_T	Nm/A	1,54
Voltage constant	k_E	V/1000 RPM	95
Winding resistance at 20° C	R_{ph}	Ω	1,57
Rotating field inductance	L_D	mH	15,2
Electrical time constant	T_{el}	ms	10
Mechanical time constant	T_{mech}	ms	1,5
Thermal time constant	T_{th}	min	25
Shaft torsional stiffness	C_t	Nm/rad	28000
Weight with brake	m_{MotBr}	kg	8,8
Weight without brake	m_{Mot}	kg	7,1

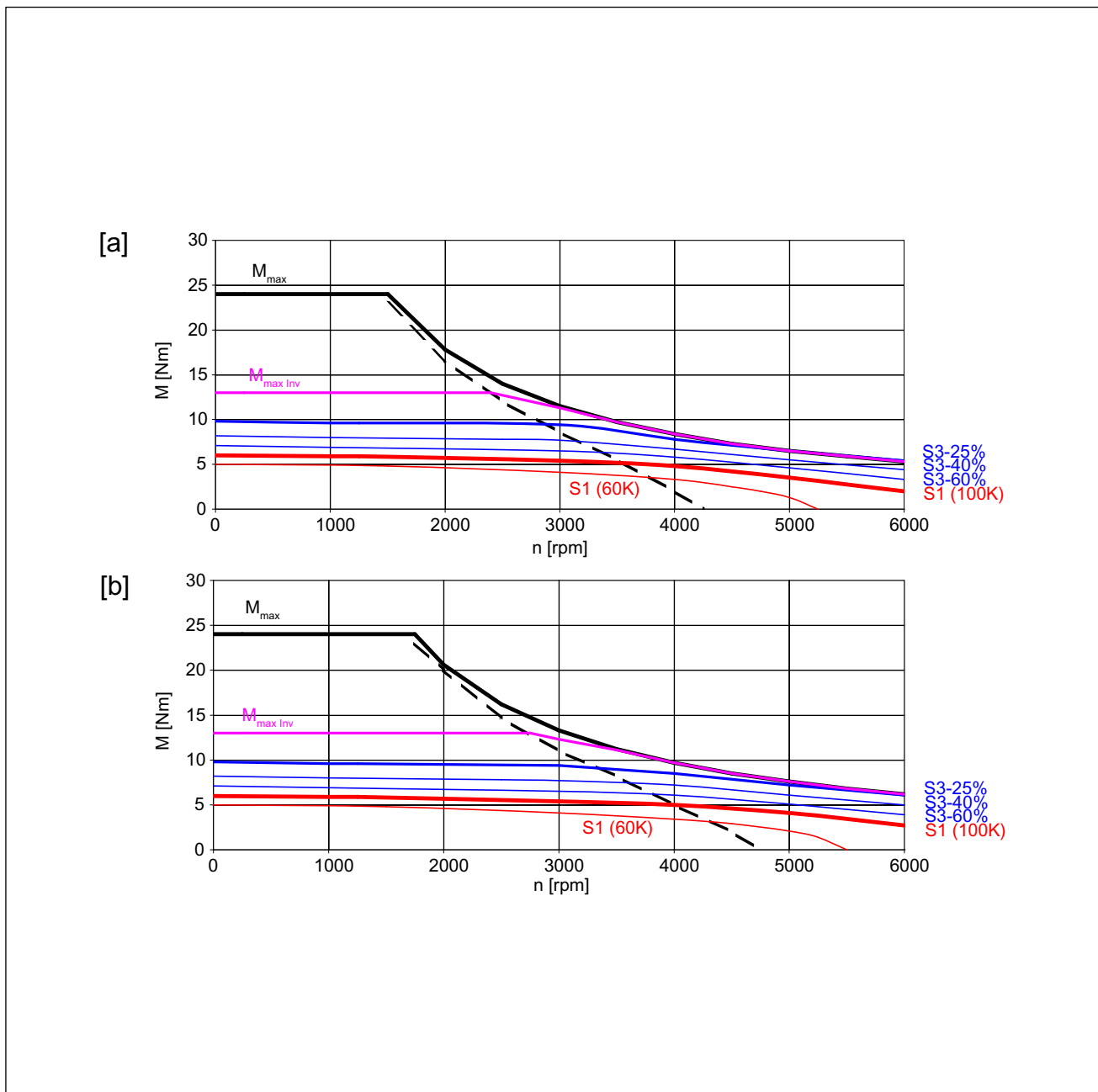

[a] SIMODRIVE 611 (UE), $V_{line} = 400 \text{ V}$, $V_{mot} = 380 \text{ V}_{rms}$

[b] SIMODRIVE 611 (ER), $V_{line} = 400 \text{ V}$, $V_{mot} = 425 \text{ V}_{rms}$

The characteristic curves are only valid for optimized converter setting data

Figure 4-15 1FT7062-□AF7

4.2 Torque-speed characteristic

Table 4- 12 1FT7062-□AK7

Technical data	Code	Unit	Value
Engineering data			
Rated speed	n_N	RPM	6000
Number of poles	2p	---	10
Rated torque (100 K)	$M_N (100\text{ K})$	Nm	3,3
Rated current (100 K)	$I_N (100\text{ K})$	A	5,4
Stall torque (60 K)	$M_0 (60\text{ K})$	Nm	5
Stall torque (100 K)	$M_0 (100\text{ K})$	Nm	6
Stall current (60 K)	$I_0 (60\text{ K})$	A	6,9
Stall current (100 K)	$I_0 (100\text{ K})$	A	8,4
Moment of inertia (with brake)	J_{MotBr}	10^{-4} kgm^2	10,2
Moment of inertia (without brake)	J_{mot}	10^{-4} kgm^2	7,36
Optimum operating point			
Optimum speed	n_{opt}	RPM	5500
Optimum power	P_{opt}	kW	2,13
Limit data			
Max. permissible speed (mech.)	$n_{max\ mech.}$	RPM	9000
Max. permissible speed (converter)	$n_{max\ conv}$	RPM	8000
Max. torque	M_{max}	Nm	24
Maximum current	I_{max}	A	47
Physical constants			
Torque constant	k_T	Nm/A	0,71
Voltage constant	k_E	V/1000 RPM	45
Winding resistance at 20° C	R_{ph}	Ω	0,34
Rotating field inductance	L_D	mH	3,4
Electrical time constant	T_{el}	ms	10
Mechanical time constant	T_{mech}	ms	1,5
Thermal time constant	T_{th}	min	25
Shaft torsional stiffness	C_t	Nm/rad	28000
Weight with brake	m_{MotBr}	kg	8,8
Weight without brake	m_{Mot}	kg	7,1

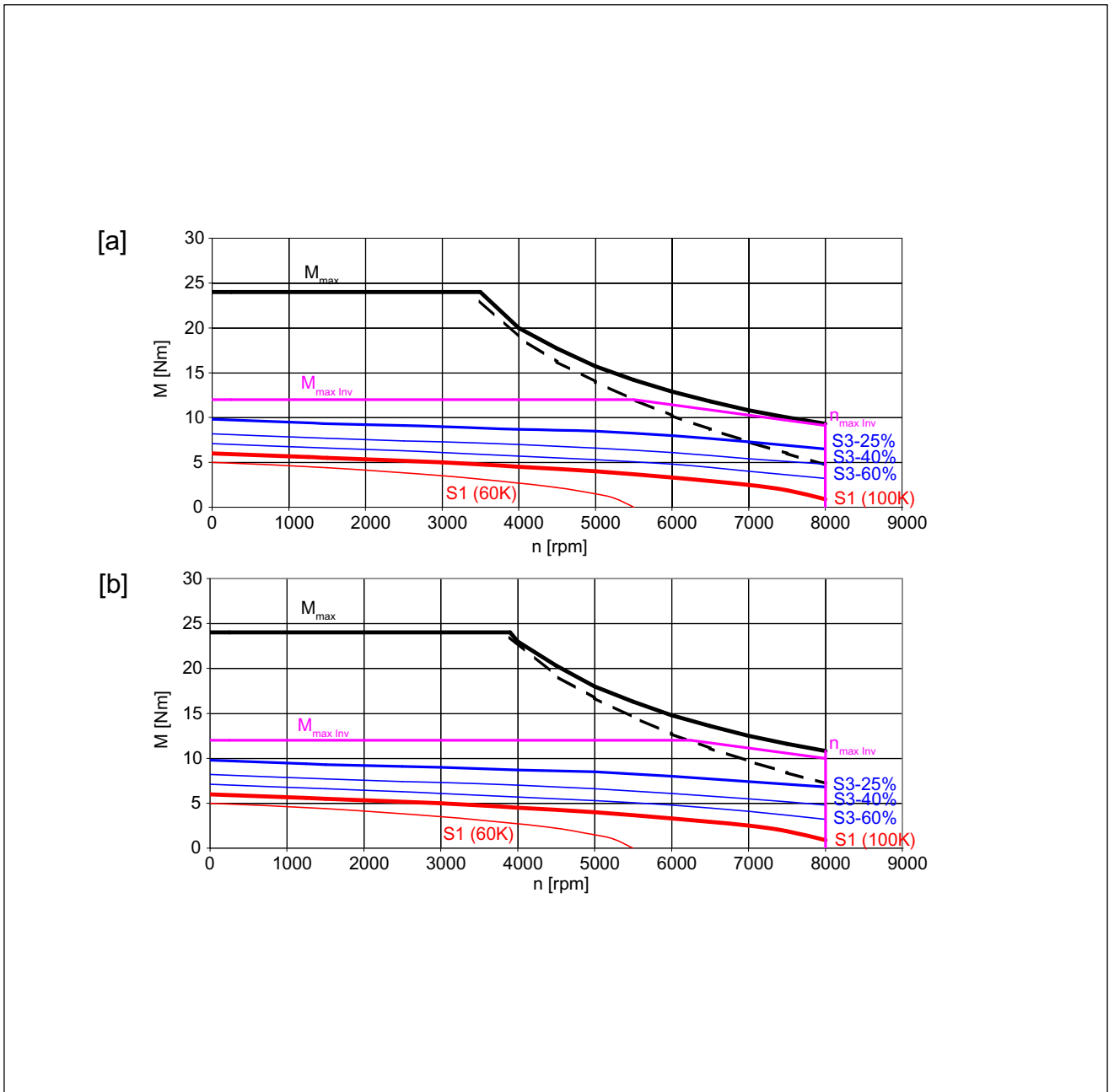

[a] SIMODRIVE 611 (UE), $V_{\text{line}} = 400 \text{ V}$, $V_{\text{mot}} = 380 \text{ V}_{\text{rms}}$

[b] SIMODRIVE 611 (ER), $V_{\text{line}} = 400 \text{ V}$, $V_{\text{mot}} = 425 \text{ V}_{\text{rms}}$

The characteristic curves are only valid for optimized converter setting data

Figure 4-16 1FT7062-□AK7

4.2 Torque-speed characteristic

Table 4- 13 1FT7064-□AF7

Technical data	Code	Unit	Value
Engineering data			
Rated speed	n_N	RPM	3000
Number of poles	2p	---	10
Rated torque (100 K)	$M_N (100\text{ K})$	Nm	7,6
Rated current (100 K)	$I_N (100\text{ K})$	A	5,2
Stall torque (60 K)	$M_0 (60\text{ K})$	Nm	7,7
Stall torque (100 K)	$M_0 (100\text{ K})$	Nm	9
Stall current (60 K)	$I_0 (60\text{ K})$	A	4,7
Stall current (100 K)	$I_0 (100\text{ K})$	A	5,7
Moment of inertia (with brake)	J_{MotBr}	10^{-4} kgm^2	14,7
Moment of inertia (without brake)	J_{mot}	10^{-4} kgm^2	11,9
Optimum operating point			
Optimum speed	n_{opt}	RPM	3000
Optimum power	P_{opt}	kW	2,39
Limit data			
Max. permissible speed (mech.)	$n_{max\ mech.}$	RPM	9000
Max. permissible speed (converter)	$n_{max\ conv}$	RPM	5700
Max. torque	M_{max}	Nm	36
Maximum current	I_{max}	A	29
Physical constants			
Torque constant	k_T	Nm/A	1,58
Voltage constant	k_E	V/1000 RPM	100
Winding resistance at 20° C	R_{ph}	Ω	0,9
Rotating field inductance	L_D	mH	10
Electrical time constant	T_{el}	ms	11
Mechanical time constant	T_{mech}	ms	1,3
Thermal time constant	T_{th}	min	30
Shaft torsional stiffness	C_t	Nm/rad	26000
Weight with brake	m_{MotBr}	kg	11,4
Weight without brake	m_{Mot}	kg	9,7

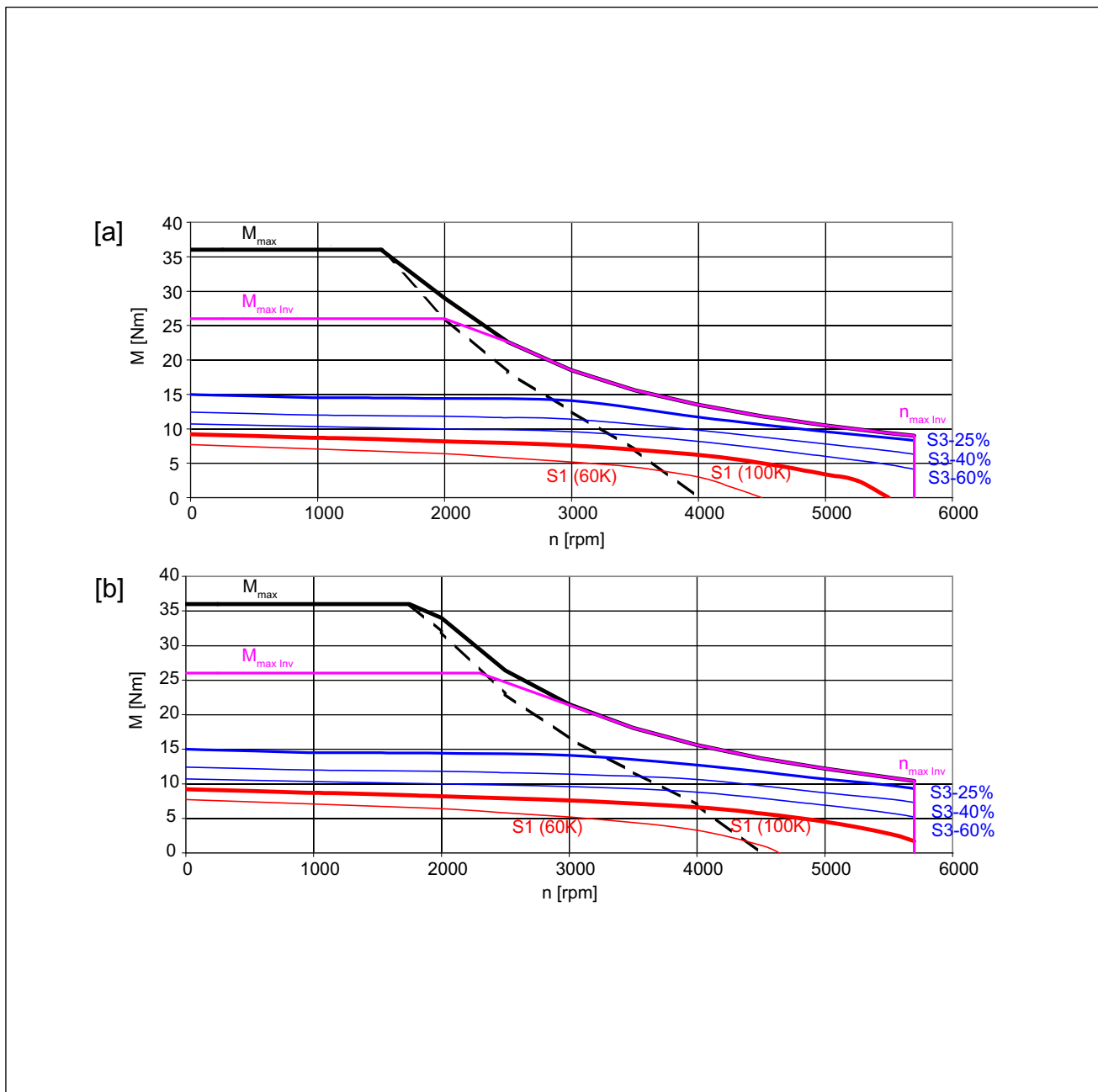

[a] SIMODRIVE 611 (UE), $V_{line} = 400 \text{ V}$, $V_{mot} = 380 \text{ V}_{rms}$

[b] SIMODRIVE 611 (ER), $V_{line} = 400 \text{ V}$, $V_{mot} = 425 \text{ V}_{rms}$

The characteristic curves are only valid for optimized converter setting data

Figure 4-17 1FT7064-□AF7

4.2 Torque-speed characteristic

Table 4- 14 1FT7064-□AK7

Technical data	Code	Unit	Value
Engineering data			
Rated speed	n_N	RPM	6000
Number of poles	2p	---	10
Rated torque (100 K)	$M_N (100\text{ K})$	Nm	2,9
Rated current (100 K)	$I_N (100\text{ K})$	A	3,4
Stall torque (60 K)	$M_0 (60\text{ K})$	Nm	7,7
Stall torque (100 K)	$M_0 (100\text{ K})$	Nm	9
Stall current (60 K)	$I_0 (60\text{ K})$	A	7,4
Stall current (100 K)	$I_0 (100\text{ K})$	A	9
Moment of inertia (with brake)	J_{MotBr}	10^{-4} kgm^2	14,7
Moment of inertia (without brake)	J_{mot}	10^{-4} kgm^2	11,9
Optimum operating point			
Optimum speed	n_{opt}	RPM	4500
Optimum power	P_{opt}	kW	2,59
Limit data			
Max. permissible speed (mech.)	$n_{max\ mech.}$	RPM	9000
Max. permissible speed (converter)	$n_{max\ conv}$	RPM	8000
Max. torque	M_{max}	Nm	36
Maximum current	I_{max}	A	45
Physical constants			
Torque constant	k_T	Nm/A	1,00
Voltage constant	k_E	V/1000 RPM	64
Winding resistance at 20° C	R_{ph}	Ω	0,38
Rotating field inductance	L_D	mH	4,1
Electrical time constant	T_{el}	ms	11
Mechanical time constant	T_{mech}	ms	1,4
Thermal time constant	T_{th}	min	30
Shaft torsional stiffness	C_t	Nm/rad	26000
Weight with brake	m_{MotBr}	kg	11,4
Weight without brake	m_{Mot}	kg	9,7

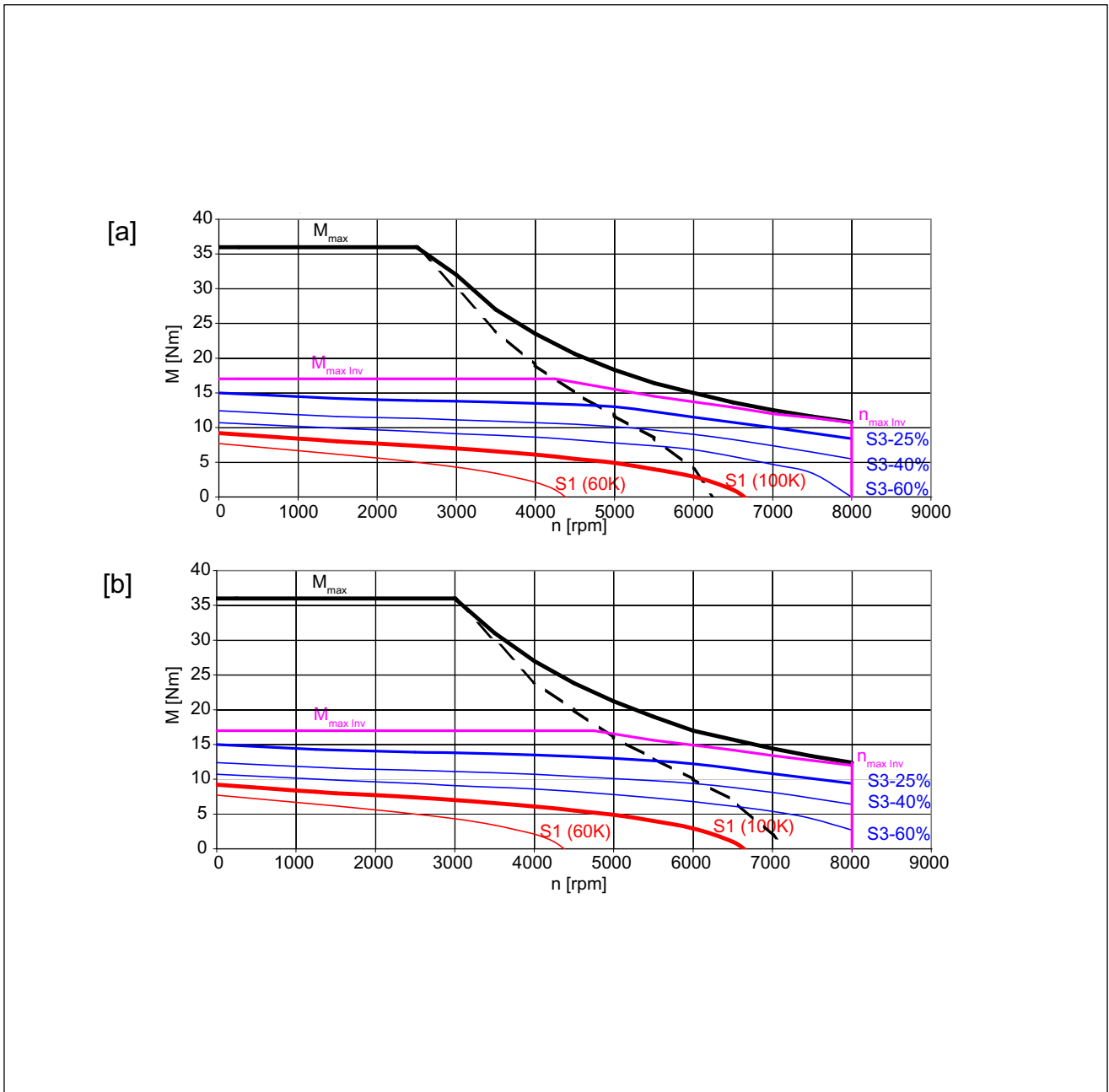

[a] SIMODRIVE 611 (UE), $V_{line} = 400 \text{ V}$, $V_{mot} = 380 \text{ V}_{rms}$

[b] SIMODRIVE 611 (ER), $V_{line} = 400 \text{ V}$, $V_{mot} = 425 \text{ V}_{rms}$

The characteristic curves are only valid for optimized converter setting data

Figure 4-18 1FT7064-□AK7

4.2 Torque-speed characteristic

Table 4- 15 1FT7066-□AF7

Technical data	Code	Unit	Value
Engineering data			
Rated speed	n_N	RPM	3000
Number of poles	2p	---	10
Rated torque (100 K)	$M_N (100\text{ K})$	Nm	9,3
Rated current (100 K)	$I_N (100\text{ K})$	A	7,2
Stall torque (60 K)	$M_0 (60\text{ K})$	Nm	10
Stall torque (100 K)	$M_0 (100\text{ K})$	Nm	12
Stall current (60 K)	$I_0 (60\text{ K})$	A	7
Stall current (100 K)	$I_0 (100\text{ K})$	A	8,4
Moment of inertia (with brake)	J_{MotBr}	10^{-4} kgm^2	19,3
Moment of inertia (without brake)	J_{mot}	10^{-4} kgm^2	16,4
Optimum operating point			
Optimum speed	n_{opt}	RPM	3000
Optimum power	P_{opt}	kW	2,92
Limit data			
Max. permissible speed (mech.)	$n_{max\ mech.}$	RPM	9000
Max. permissible speed (converter)	$n_{max\ conv}$	RPM	6500
Max. torque	M_{max}	Nm	49
Maximum current	I_{max}	A	44
Physical constants			
Torque constant	k_T	Nm/A	1,43
Voltage constant	k_E	V/1000 RPM	89,5
Winding resistance at 20° C	R_{ph}	Ω	0,49
Rotating field inductance	L_D	mH	5,5
Electrical time constant	T_{el}	ms	11
Mechanical time constant	T_{mech}	ms	1,2
Thermal time constant	T_{th}	min	40
Shaft torsional stiffness	C_t	Nm/rad	24000
Weight with brake	m_{MotBr}	kg	14,1
Weight without brake	m_{Mot}	kg	12,3

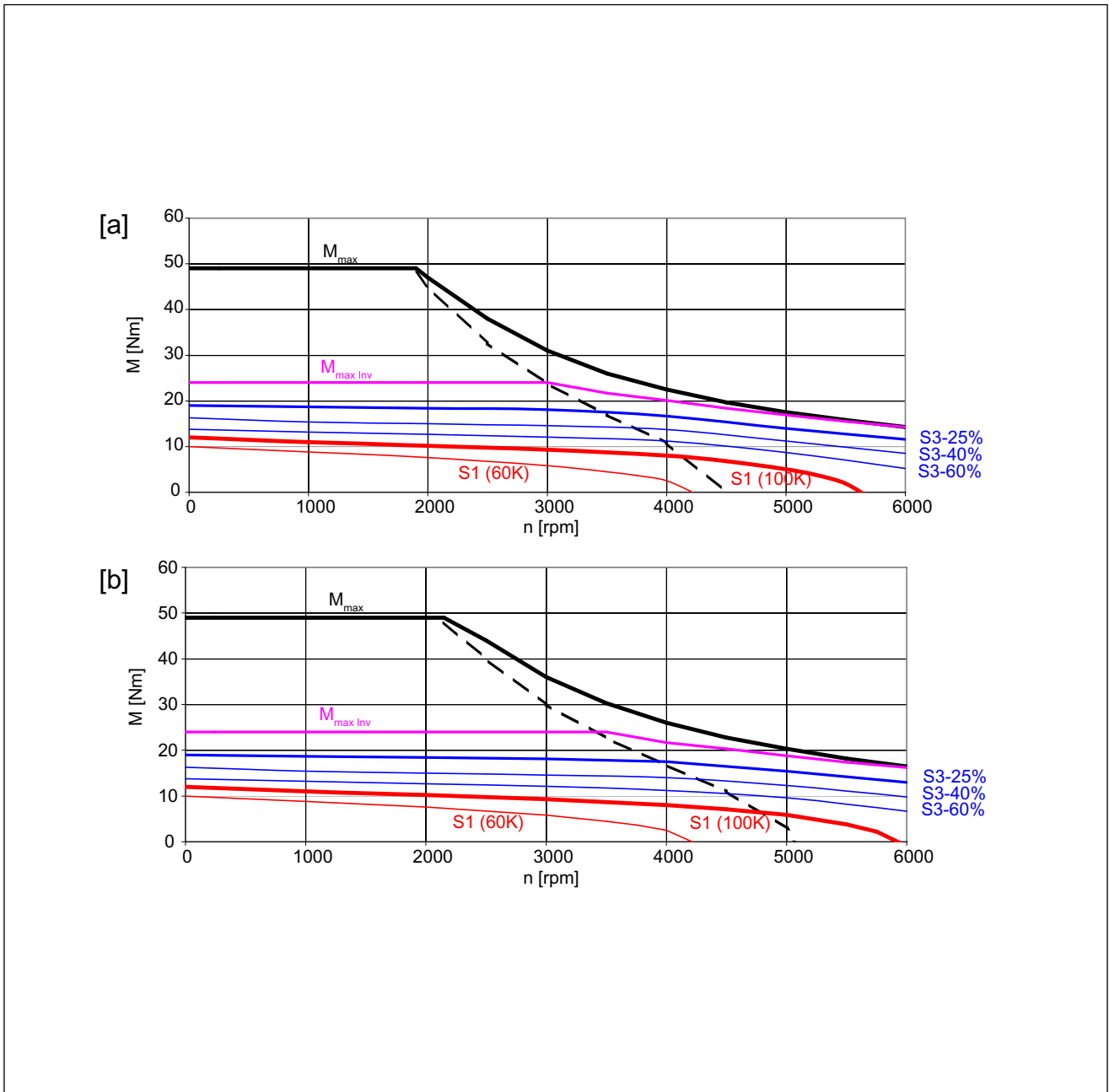

[a] SIMODRIVE 611 (UE), $V_{line} = 400 V$, $V_{mot} = 380 V_{rms}$

[b] SIMODRIVE 611 (ER), $V_{line} = 400 V$, $V_{mot} = 425 V_{rms}$

The characteristic curves are only valid for optimized converter setting data

Figure 4-19 1FT7066-□AF7

4.2 Torque-speed characteristic

Table 4- 16 1FT7066-□AH7

Technical data	Code	Unit	Value
Engineering data			
Rated speed	n_N	RPM	4500
Number of poles	2p	---	10
Rated torque (100 K)	$M_N (100\text{ K})$	Nm	5
Rated current (100 K)	$I_N (100\text{ K})$	A	6,3
Stall torque (60 K)	$M_0 (60\text{ K})$	Nm	10
Stall torque (100 K)	$M_0 (100\text{ K})$	Nm	12
Stall current (60 K)	$I_0 (60\text{ K})$	A	10,1
Stall current (100 K)	$I_0 (100\text{ K})$	A	13,6
Moment of inertia (with brake)	J_{MotBr}	10^{-4} kgm^2	19,3
Moment of inertia (without brake)	J_{mot}	10^{-4} kgm^2	16,4
Optimum operating point			
Optimum speed	n_{opt}	RPM	4000
Optimum power	P_{opt}	kW	2,55
Limit data			
Max. permissible speed (mech.)	$n_{max\ mech.}$	RPM	9000
Max. permissible speed (converter)	$n_{max\ conv}$	RPM	8000
Max. torque	M_{max}	Nm	49
Maximum current	I_{max}	A	70
Physical constants			
Torque constant	k_T	Nm/A	0,88
Voltage constant	k_E	V/1000 RPM	56,5
Winding resistance at 20° C	R_{ph}	Ω	0,185
Rotating field inductance	L_D	mH	2,3
Electrical time constant	T_{el}	ms	12
Mechanical time constant	T_{mech}	ms	1,2
Thermal time constant	T_{th}	min	40
Shaft torsional stiffness	C_t	Nm/rad	24000
Weight with brake	m_{MotBr}	kg	14,1
Weight without brake	m_{Mot}	kg	12,3

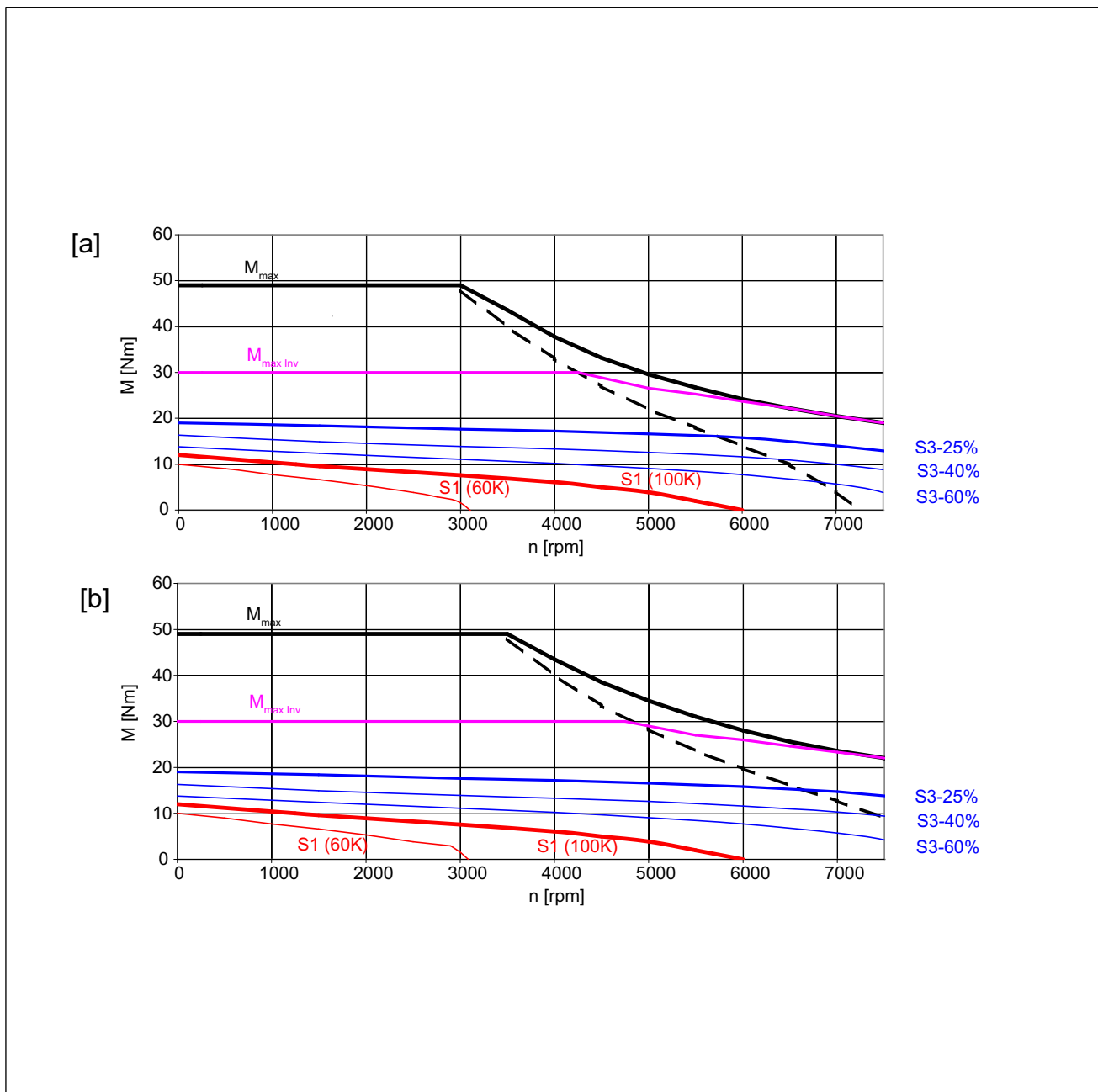

[a] SIMODRIVE 611 (UE), $V_{line} = 400 \text{ V}$, $V_{mot} = 380 \text{ V}_{rms}$

[b] SIMODRIVE 611 (ER), $V_{line} = 400 \text{ V}$, $V_{mot} = 425 \text{ V}_{rms}$

The characteristic curves are only valid for optimized converter setting data

Figure 4-20 1FT7066-□AH7

4.2 Torque-speed characteristic

Table 4- 17 1FT7068-□AF7

Technical data	Code	Unit	Value
Engineering data			
Rated speed	n_N	RPM	3000
Number of poles	2p	---	10
Rated torque (100 K)	$M_N (100 K)$	Nm	10,9
Rated current (100 K)	$I_N (100 K)$	A	6,7
Stall torque (60 K)	$M_0 (60 K)$	Nm	13
Stall torque (100 K)	$M_0 (100 K)$	Nm	15
Stall current (60 K)	$I_0 (60 K)$	A	7,1
Stall current (100 K)	$I_0 (100 K)$	A	8,3
Moment of inertia (with brake)	J_{MotBr}	10^{-4} kgm ²	26,1
Moment of inertia (without brake)	J_{mot}	10^{-4} kgm ²	23,2
Optimum operating point			
Optimum speed	n_{opt}	RPM	3000
Optimum power	P_{opt}	kW	3,42
Limit data			
Max. permissible speed (mech.)	$n_{max mech.}$	RPM	9000
Max. permissible speed (converter)	$n_{max conv}$	RPM	5100
Max. torque	M_{max}	Nm	63
Maximum current	I_{max}	A	43
Physical constants			
Torque constant	k_T	Nm/A	1,81
Voltage constant	k_E	V/1000 RPM	114
Winding resistance at 20° C	R_{ph}	Ω	0,53
Rotating field inductance	L_D	mH	6,4
Electrical time constant	T_{el}	ms	12
Mechanical time constant	T_{mech}	ms	1,1
Thermal time constant	T_{th}	min	45
Shaft torsional stiffness	C_t	Nm/rad	21400
Weight with brake	m_{MotBr}	kg	18
Weight without brake	m_{Mot}	kg	16,3

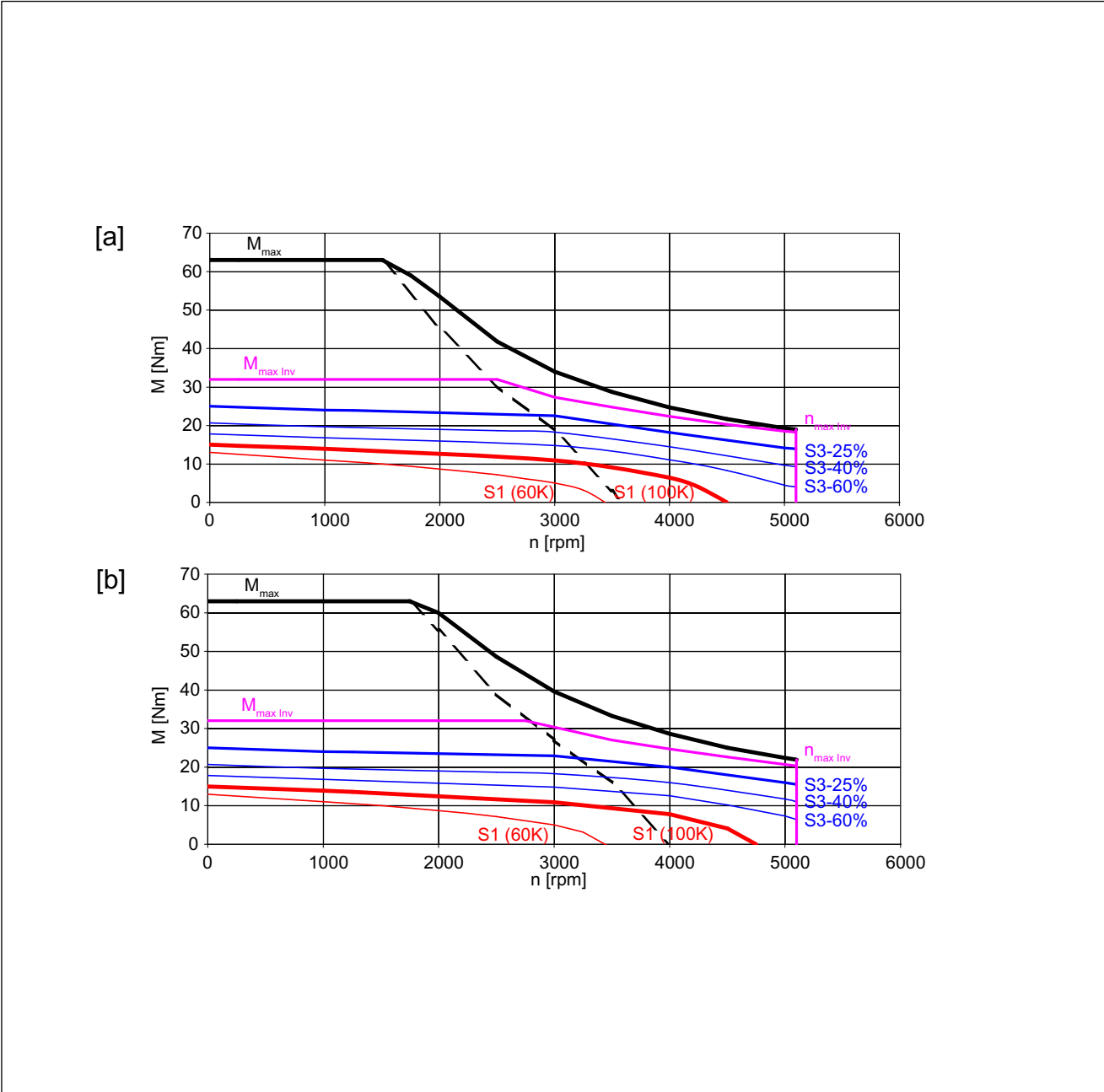

[a] SIMODRIVE 611 (UE), $V_{line} = 400 \text{ V}$, $V_{mot} = 380 \text{ V}_{rms}$

[b] SIMODRIVE 611 (ER), $V_{line} = 400 \text{ V}$, $V_{mot} = 425 \text{ V}_{rms}$

The characteristic curves are only valid for optimized converter setting data

Figure 4-21 1FT7068-□AF7

4.2 Torque-speed characteristic

Table 4- 18 1FT7082-□AC7

Technical data	Code	Unit	Value
Configuration data			
Rated speed	n_N	rpm	2000
Number of poles	2p	---	10
Rated torque (100 K)	$M_N (100\text{ K})$	Nm	11.4
Rated current (100 K)	$I_N (100\text{ K})$	A	4.9
Static torque (60 K)	$M_0 (60\text{ K})$	Nm	10.6
Static torque (100 K)	$M_0 (100\text{ K})$	Nm	13
Stall current (60 K)	$I_0 (60\text{ K})$	A	4
Stall current (100 K)	$I_0 (100\text{ K})$	A	5
Moment of inertia (with brake)	J_{MotBr}	10^{-4} kgm^2	41.9
Moment of inertia (without brake)	J_{Mot}	10^{-4} kgm^2	26.5
Optimum operating point			
Optimum speed	n_{opt}	rpm	2000
Optimum power	P_{opt}	kW	2.39
Limiting data			
Max. permissible speed (mech.)	$n_{max\ mech}$	rpm	8000
Max. permissible speed (inverter)	$n_{max\ inv}$	rpm	3500
Maximum torque	M_{max}	Nm	52
Maximum current	I_{max}	A	26
Physical constants			
Torque constant	k_T	Nm/A	2.60
Voltage constant	k_E	V/1000 rpm	162
Winding resistance at 20 °C	R_{St}	Ω	1.38
Rotating field inductance	L_D	mH	21
Electrical time constant	T_{el}	ms	15
Mechanical time constant	T_{mech}	ms	1.7
Thermal time constant	T_{th}	min	40
Shaft torsional stiffness	C_t	Nm/rad	75700
Weight with brake	m_{MotBr}	kg	18.3
Weight without brake	m_{Mot}	kg	14

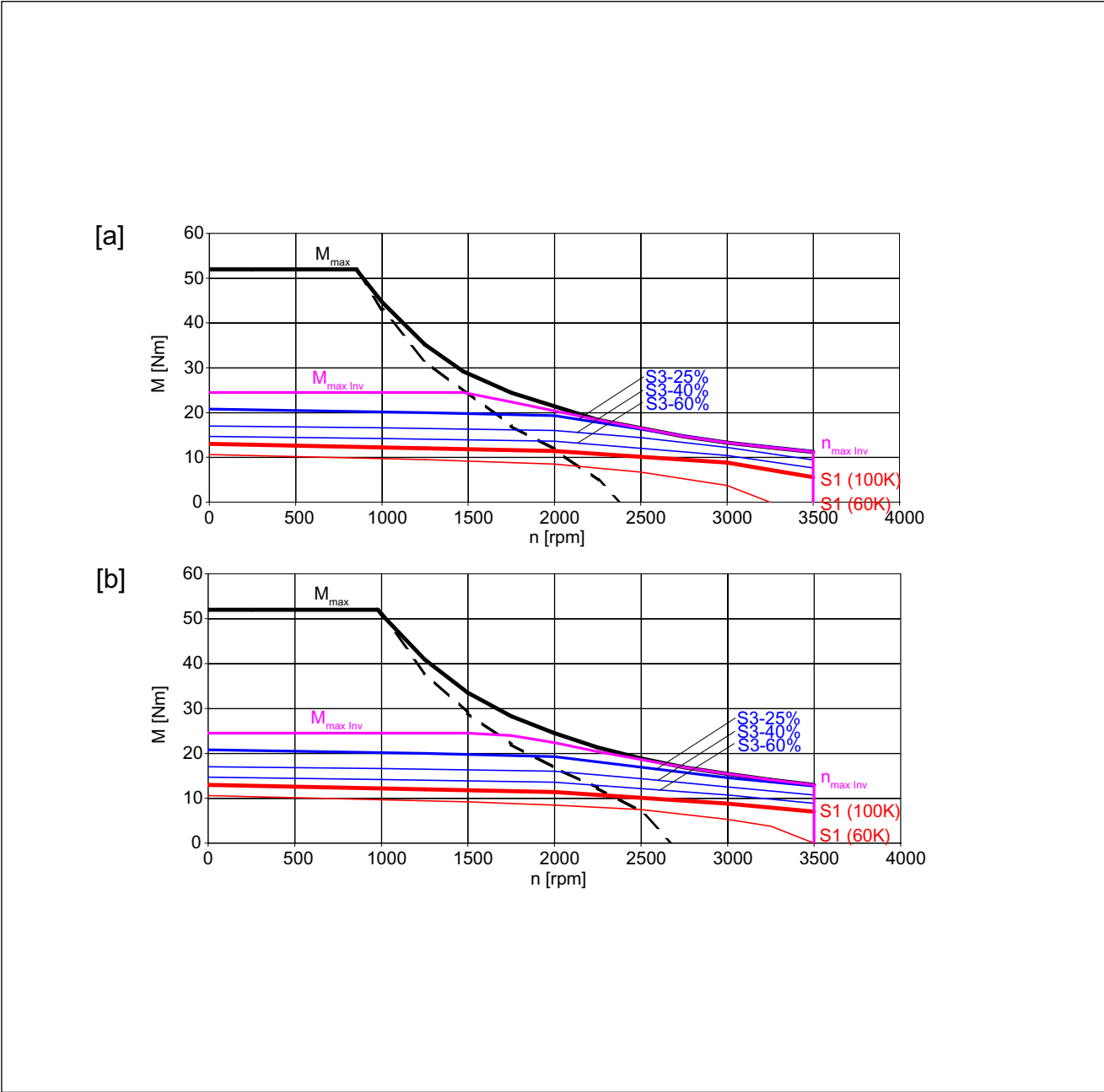

[a] SIMODRIVE 611 (UE), $V_{line} = 400 \text{ V}$, $V_{mot} = 380 \text{ V}_{rms}$

[b] SIMODRIVE 611 (ER), $V_{line} = 400 \text{ V}$, $V_{mot} = 425 \text{ V}_{rms}$

The characteristic curves are only valid for optimized inverter setting data

Figure 4-22 1FT7082-□AC7

4.2 Torque-speed characteristic

Table 4- 19 1FT7082-□AF7

Technical data	Code	Unit	Value
Configuration data			
Rated speed	n_N	rpm	3000
Number of poles	2p	---	10
Rated torque (100 K)	$M_N (100 K)$	Nm	10.3
Rated current (100 K)	$I_N (100 K)$	A	6.6
Static torque (60 K)	$M_0 (60 K)$	Nm	10.6
Static torque (100 K)	$M_0 (100 K)$	Nm	13
Stall current (60 K)	$I_0 (60 K)$	A	6.1
Stall current (100 K)	$I_0 (100 K)$	A	7.6
Moment of inertia (with brake)	J_{MotBr}	10^{-4} kgm^2	41.9
Moment of inertia (without brake)	J_{Mot}	10^{-4} kgm^2	26.5
Optimum operating point			
Optimum speed	n_{opt}	rpm	3000
Optimum power	P_{opt}	kW	3.24
Limiting data			
Max. permissible speed (mech.)	$n_{max \text{ mech}}$	rpm	8000
Max. permissible speed (inverter)	$n_{max \text{ Inv}}$	rpm	5400
Maximum torque	M_{max}	Nm	52
Maximum current	I_{max}	A	39
Physical constants			
Torque constant	k_T	Nm/A	1.71
Voltage constant	k_E	V/1000 rpm	108
Winding resistance at 20 °C	R_{St}	Ω	0.59
Rotating field inductance	L_D	mH	9.3
Electrical time constant	T_{el}	ms	16
Mechanical time constant	T_{mech}	ms	1.6
Thermal time constant	T_{th}	min	40
Shaft torsional stiffness	C_t	Nm/rad	75700
Weight with brake	m_{MotBr}	kg	18.3
Weight without brake	m_{Mot}	kg	14

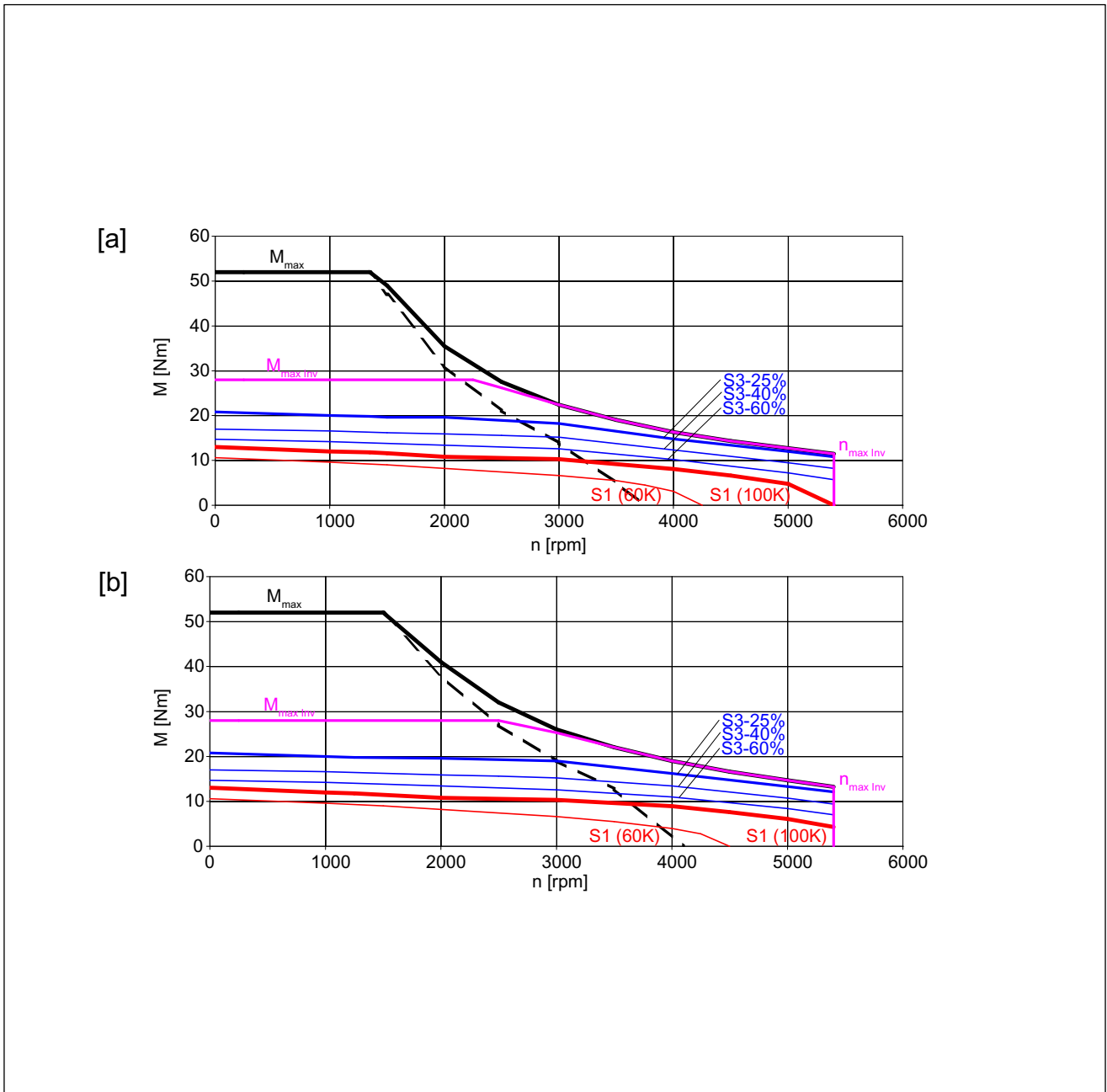

[a] SIMODRIVE 611 (UE), $V_{line} = 400\text{ V}$, $V_{mot} = 380\text{ V}_{rms}$

[b] SIMODRIVE 611 (ER), $V_{line} = 400\text{ V}$, $V_{mot} = 425\text{ V}_{rms}$

The characteristic curves are only valid for optimized inverter setting data

Figure 4-23 1FT7082-□AF7

4.2 Torque-speed characteristic

Table 4- 20 1FT7082-□AH7

Technical data	Code	Unit	Value
Configuration data			
Rated speed	n_N	rpm	4500
Number of poles	$2p$	---	10
Rated torque (100 K)	$M_N (100\text{ K})$	Nm	8
Rated current (100 K)	$I_N (100\text{ K})$	A	7.8
Static torque (60 K)	$M_0 (60\text{ K})$	Nm	10.6
Static torque (100 K)	$M_0 (100\text{ K})$	Nm	13
Stall current (60 K)	$I_0 (60\text{ K})$	A	10
Stall current (100 K)	$I_0 (100\text{ K})$	A	12.3
Moment of inertia (with brake)	J_{MotBr}	10^{-4} kgm^2	41.9
Moment of inertia (without brake)	J_{Mot}	10^{-4} kgm^2	26.5
Optimum operating point			
Optimum speed	n_{opt}	rpm	4500
Optimum power	P_{opt}	kW	3.77
Limiting data			
Max. permissible speed (mech.)	$n_{max\ mech}$	rpm	8000
Max. permissible speed (inverter)	$n_{max\ Inv}$	rpm	8000
Maximum torque	M_{max}	Nm	52
Maximum current	I_{max}	A	63
Physical constants			
Torque constant	k_T	Nm/A	1.06
Voltage constant	k_E	V/1000 rpm	66.5
Winding resistance at 20 °C	R_{Str}	Ω	0.23
Rotating field inductance	L_D	mH	3.5
Electrical time constant	T_{el}	ms	15
Mechanical time constant	T_{mech}	ms	1.6
Thermal time constant	T_{th}	min	40
Shaft torsional stiffness	C_t	Nm/rad	75700
Weight with brake	m_{MotBr}	kg	18.3
Weight without brake	m_{Mot}	kg	14

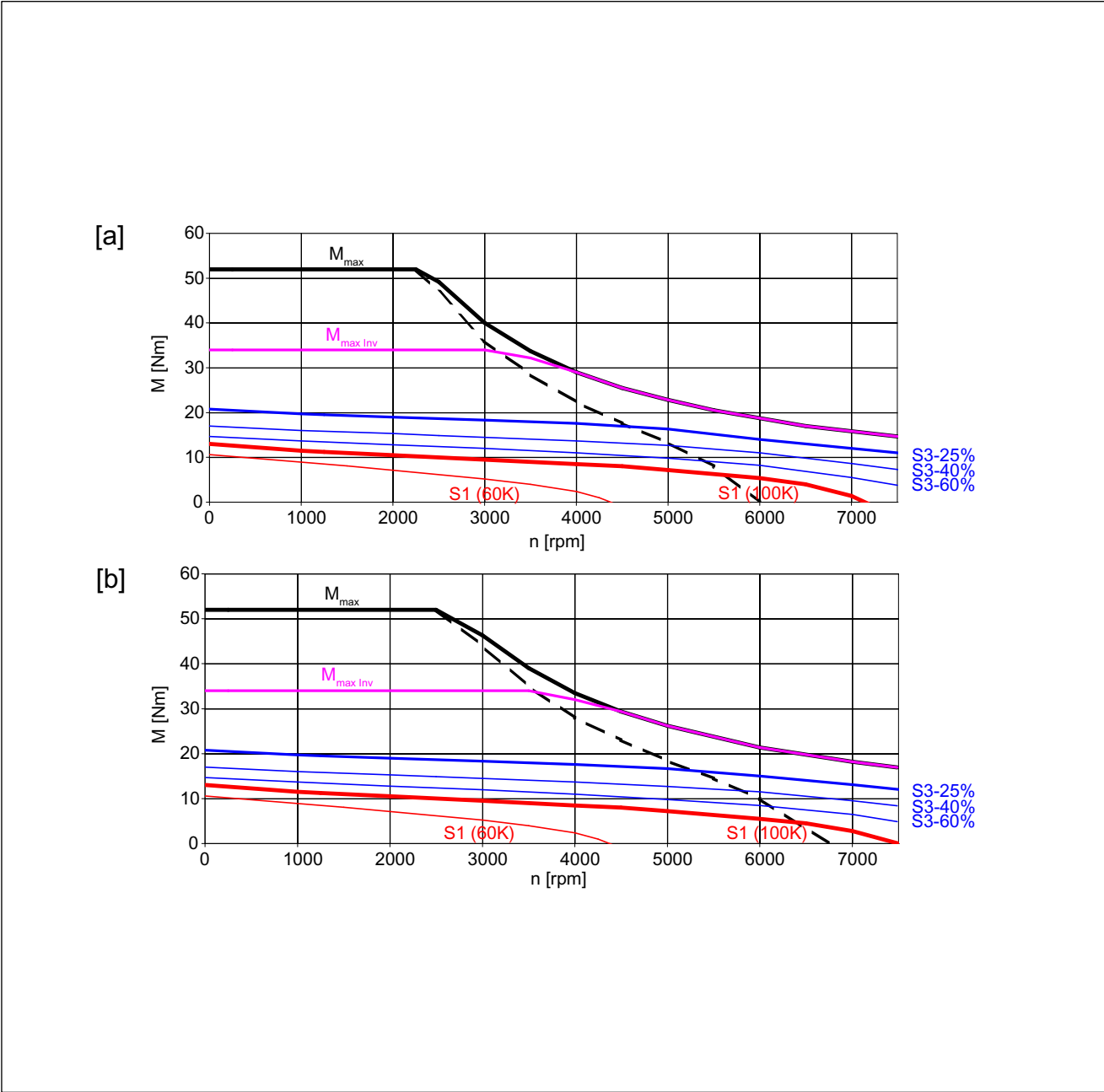

[a] SIMODRIVE 611 (UE), $V_{line} = 400 \text{ V}$, $V_{mot} = 380 \text{ V}_{rms}$

[b] SIMODRIVE 611 (ER), $V_{line} = 400 \text{ V}$, $V_{mot} = 425 \text{ V}_{rms}$

The characteristic curves are only valid for optimized inverter setting data

Figure 4-24 1FT7082-□AH7

4.2 Torque-speed characteristic

Table 4- 21 1FT7084-□AC7

Technical data	Code	Unit	Value
Configuration data			
Rated speed	n_N	rpm	2000
Number of poles	2p	---	10
Rated torque (100 K)	$M_N (100\text{ K})$	Nm	16.9
Rated current (100 K)	$I_N (100\text{ K})$	A	8.4
Static torque (60 K)	$M_0 (60\text{ K})$	Nm	16.8
Static torque (100 K)	$M_0 (100\text{ K})$	Nm	20
Stall current (60 K)	$I_0 (60\text{ K})$	A	7.4
Stall current (100 K)	$I_0 (100\text{ K})$	A	9
Moment of inertia (with brake)	J_{MotBr}	10^{-4} kgm^2	60.4
Moment of inertia (without brake)	J_{Mot}	10^{-4} kgm^2	45.1
Optimum operating point			
Optimum speed	n_{opt}	rpm	2000
Optimum power	P_{opt}	kW	3.54
Limiting data			
Max. permissible speed (mech.)	$n_{max\ mech}$	rpm	8000
Max. permissible speed (inverter)	$n_{max\ inv}$	rpm	4000
Maximum torque	M_{max}	Nm	81
Maximum current	I_{max}	A	46
Physical constants			
Torque constant	k_T	Nm/A	2.22
Voltage constant	k_E	V/1000 rpm	142
Winding resistance at 20 °C	R_{St}	Ω	0.52
Rotating field inductance	L_D	mH	8.5
Electrical time constant	T_{el}	ms	16
Mechanical time constant	T_{mech}	ms	1.5
Thermal time constant	T_{th}	min	55
Shaft torsional stiffness	C_t	Nm/rad	65100
Weight with brake	m_{MotBr}	kg	25.1
Weight without brake	m_{Mot}	kg	20.8

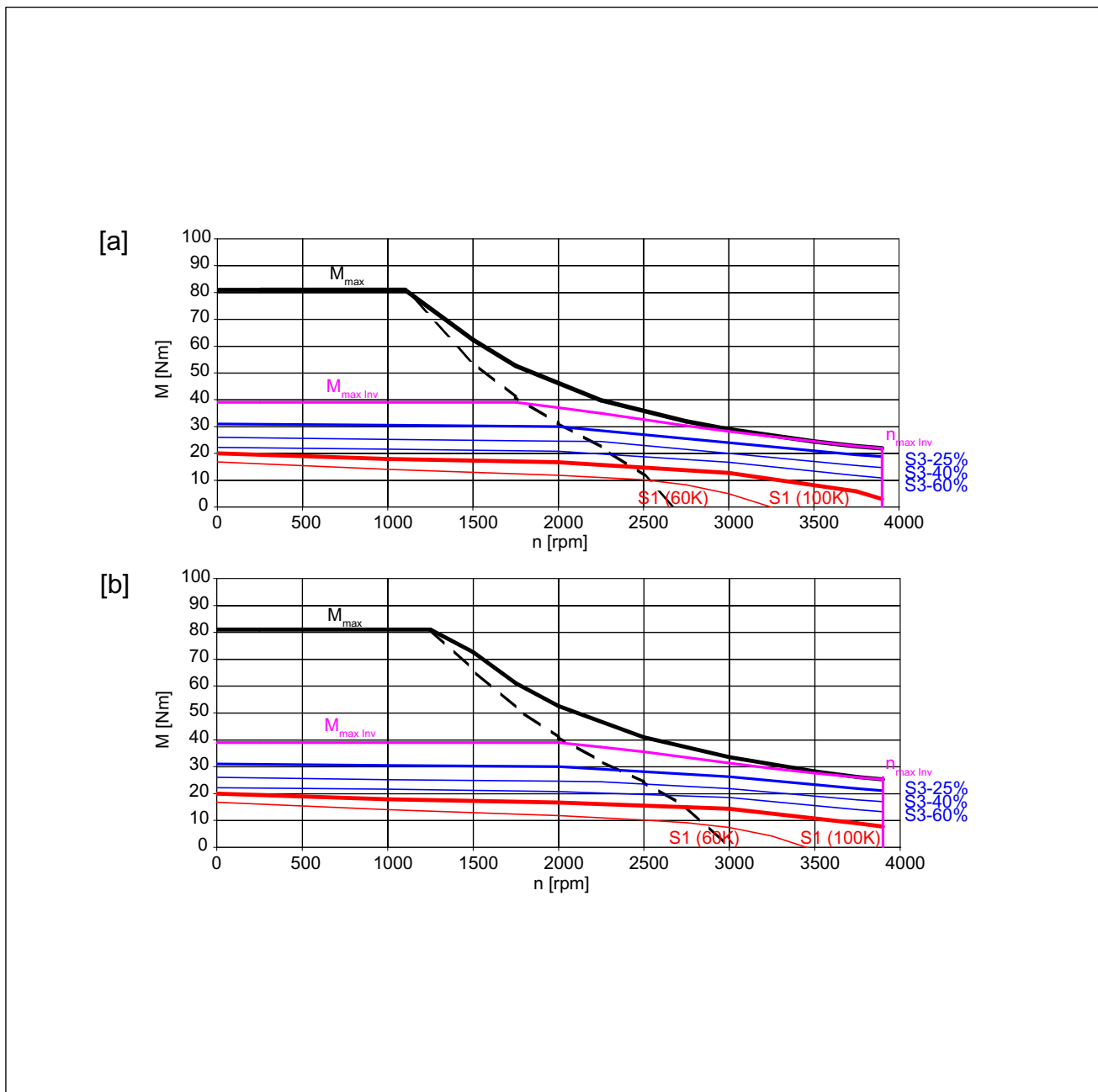

4.2 Torque-speed characteristic

Table 4- 22 1FT7084-□AF7

Technical data	Code	Unit	Value
Configuration data			
Rated speed	n_N	rpm	3000
Number of poles	2p	---	10
Rated torque (100 K)	$M_N (100 K)$	Nm	14.5
Rated current (100 K)	$I_N (100 K)$	A	8.5
Static torque (60 K)	$M_0 (60 K)$	Nm	16.8
Static torque (100 K)	$M_0 (100 K)$	Nm	20
Stall current (60 K)	$I_0 (60 K)$	A	8.5
Stall current (100 K)	$I_0 (100 K)$	A	11
Moment of inertia (with brake)	J_{MotBr}	10^{-4} kgm^2	60.4
Moment of inertia (without brake)	J_{Mot}	10^{-4} kgm^2	45.1
Optimum operating point			
Optimum speed	n_{opt}	rpm	3000
Optimum power	P_{opt}	kW	4.55
Limiting data			
Max. permissible speed (mech.)	$n_{max \text{ mech}}$	rpm	8000
Max. permissible speed (inverter)	$n_{max \text{ Inv}}$	rpm	5000
Maximum torque	M_{max}	Nm	81
Maximum current	I_{max}	A	55
Physical constants			
Torque constant	k_T	Nm/A	1.82
Voltage constant	k_E	V/1000 rpm	116
Winding resistance at 20 °C	R_{St}	Ω	0.34
Rotating field inductance	L_D	mH	6
Electrical time constant	T_{el}	ms	18
Mechanical time constant	T_{mech}	ms	1.4
Thermal time constant	T_{th}	min	55
Shaft torsional stiffness	C_t	Nm/rad	65100
Weight with brake	m_{MotBr}	kg	25.1
Weight without brake	m_{Mot}	kg	20.8

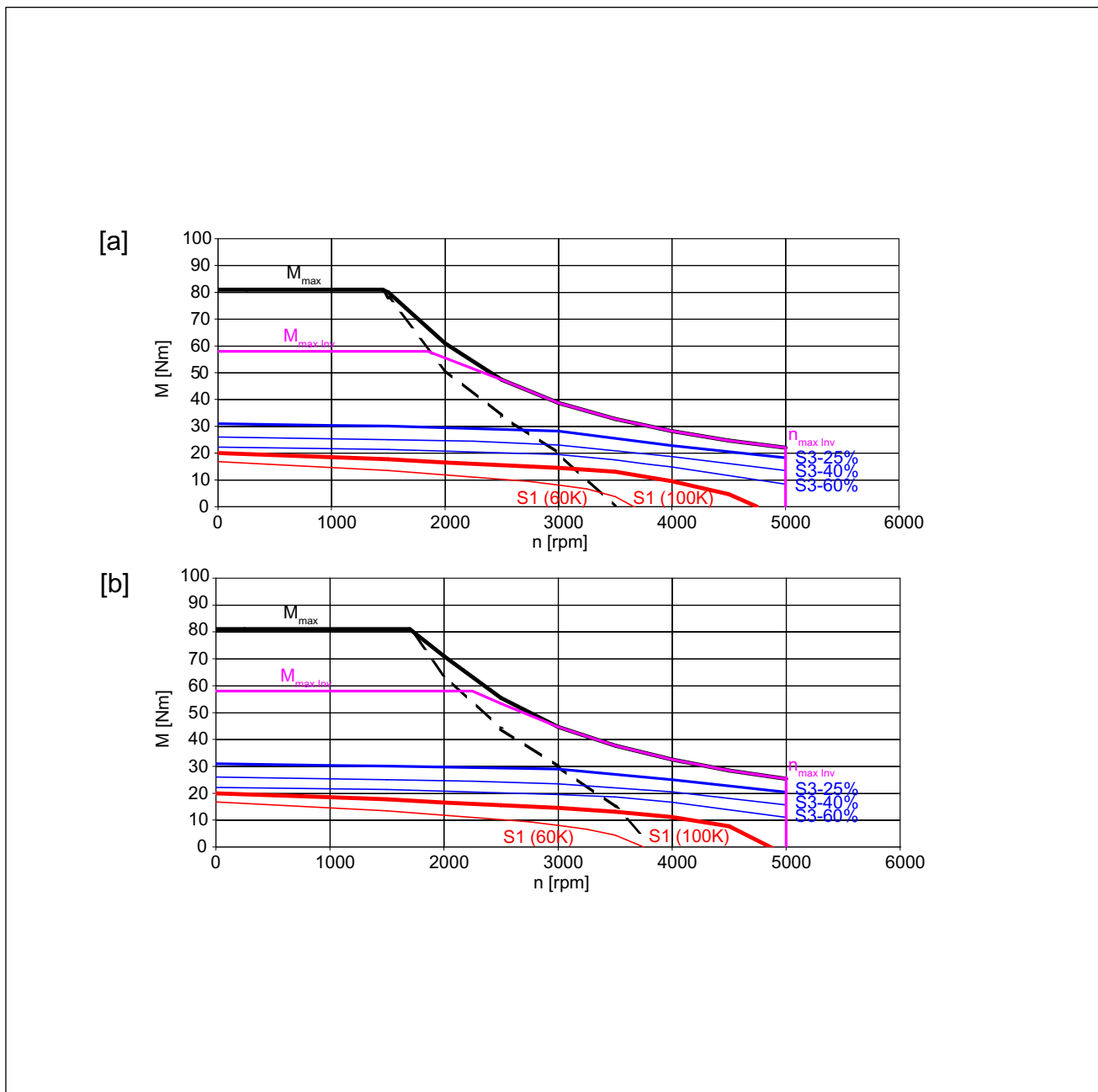

[a] SIMODRIVE 611 (UE), $V_{line} = 400 \text{ V}$, $V_{mot} = 380 \text{ V}_{rms}$

[b] SIMODRIVE 611 (ER), $V_{line} = 400 \text{ V}$, $V_{mot} = 425 \text{ V}_{rms}$

The characteristic curves are only valid for optimized inverter setting data

Figure 4-26 1FT7084-□AF7

4.2 Torque-speed characteristic

Table 4- 23 1FT7084-□AH7

Technical data	Code	Unit	Value
Configuration data			
Rated speed	n_N	rpm	4500
Number of poles	$2p$	---	10
Rated torque (100 K)	$M_N (100 K)$	Nm	9.5
Rated current (100 K)	$I_N (100 K)$	A	7.8
Static torque (60 K)	$M_0 (60 K)$	Nm	16.8
Static torque (100 K)	$M_0 (100 K)$	Nm	20
Stall current (60 K)	$I_0 (60 K)$	A	13
Stall current (100 K)	$I_0 (100 K)$	A	15.6
Moment of inertia (with brake)	J_{MotBr}	10^{-4} kgm ²	60.4
Moment of inertia (without brake)	J_{Mot}	10^{-4} kgm ²	45.1
Optimum operating point			
Optimum speed	n_{opt}	rpm	4000
Optimum power	P_{opt}	kW	4.82
Limiting data			
Max. permissible speed (mech.)	$n_{max mech}$	rpm	8000
Max. permissible speed (inverter)	$n_{max Inv}$	rpm	7200
Maximum torque	M_{max}	Nm	81
Maximum current	I_{max}	A	80
Physical constants			
Torque constant	k_T	Nm/A	1.28
Voltage constant	k_E	V/1000 rpm	80
Winding resistance at 20 °C	R_{Str}	Ω	0.17
Rotating field inductance	L_D	mH	2.9
Electrical time constant	T_{el}	ms	17
Mechanical time constant	T_{mech}	ms	1.4
Thermal time constant	T_{th}	min	55
Shaft torsional stiffness	C_t	Nm/rad	65100
Weight with brake	m_{MotBr}	kg	25.1
Weight without brake	m_{Mot}	kg	20.8

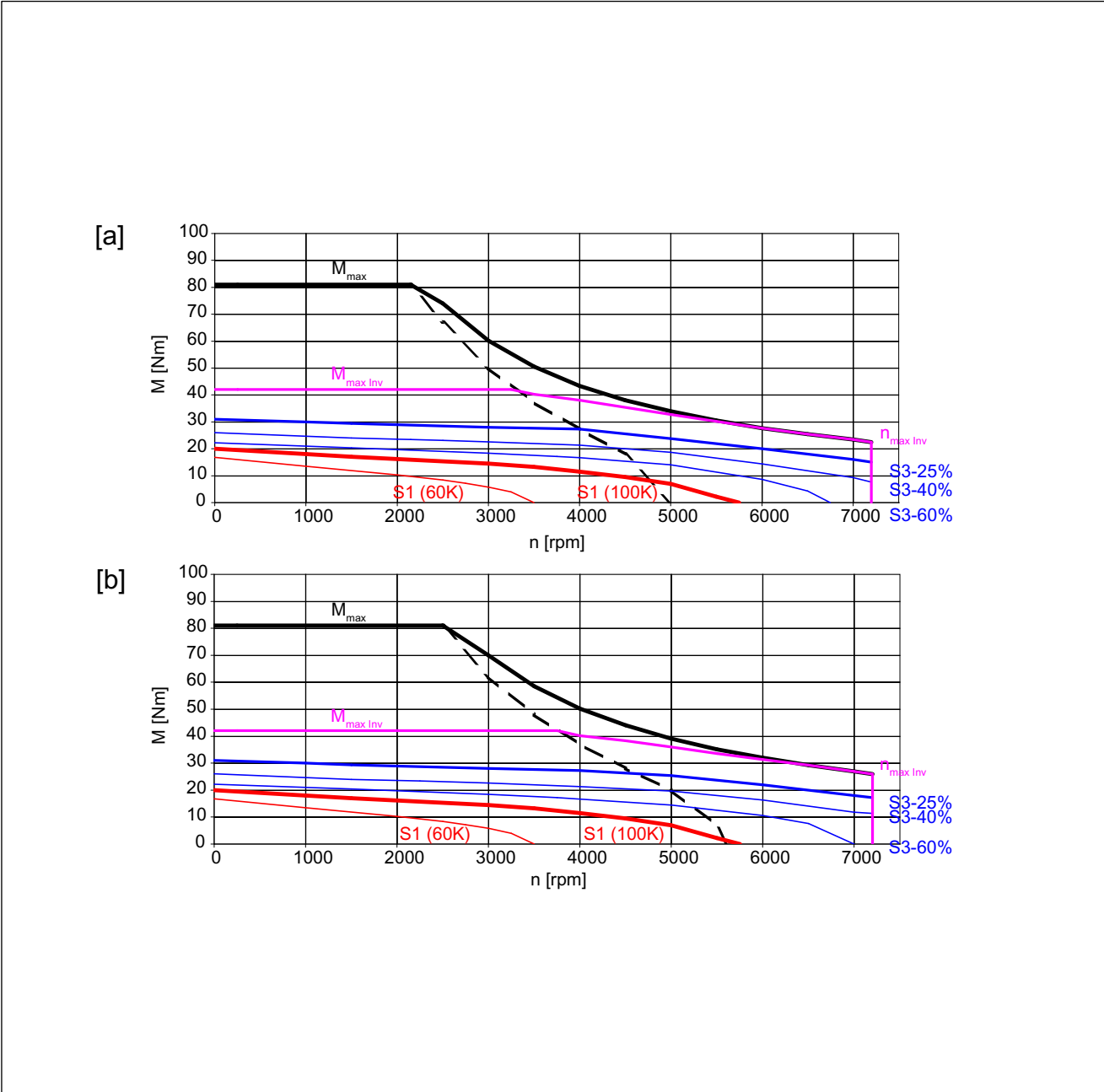

[a] SIMODRIVE 611 (UE), $V_{line} = 400 V$, $V_{mot} = 380 V_{rms}$
 [b] SIMODRIVE 611 (ER), $V_{line} = 400 V$, $V_{mot} = 425 V_{rms}$
 The characteristic curves are only valid for optimized inverter setting data

Figure 4-27 1FT7084-□AH7

4.2 Torque-speed characteristic

Table 4- 24 1FT7086-□AC7

Technical data	Code	Unit	Value
Configuration data			
Rated speed	n_N	rpm	2000
Number of poles	2p	---	10
Rated torque (100 K)	$M_N (100 K)$	Nm	22.5
Rated current (100 K)	$I_N (100 K)$	A	9.2
Static torque (60 K)	$M_0 (60 K)$	Nm	23
Static torque (100 K)	$M_0 (100 K)$	Nm	28
Stall current (60 K)	$I_0 (60 K)$	A	8.6
Stall current (100 K)	$I_0 (100 K)$	A	10.6
Moment of inertia (with brake)	J_{MotBr}	10^{-4} kgm^2	79
Moment of inertia (without brake)	J_{Mot}	10^{-4} kgm^2	63.6
Optimum operating point			
Optimum speed	n_{opt}	rpm	2000
Optimum power	P_{opt}	kW	4.71
Limiting data			
Max. permissible speed (mech.)	$n_{max \text{ mech}}$	rpm	8000
Max. permissible speed (inverter)	$n_{max \text{ Inv}}$	rpm	3500
Maximum torque	M_{max}	Nm	120
Maximum current	I_{max}	A	54
Physical constants			
Torque constant	k_T	Nm/A	2.64
Voltage constant	k_E	V/1000 rpm	166
Winding resistance at 20 °C	R_{St}	Ω	0.46
Rotating field inductance	L_D	mH	8.5
Electrical time constant	T_{el}	ms	18
Mechanical time constant	T_{mech}	ms	1.3
Thermal time constant	T_{th}	min	60
Shaft torsional stiffness	C_t	Nm/rad	57000
Weight with brake	m_{MotBr}	kg	31.8
Weight without brake	m_{Mot}	kg	27.5

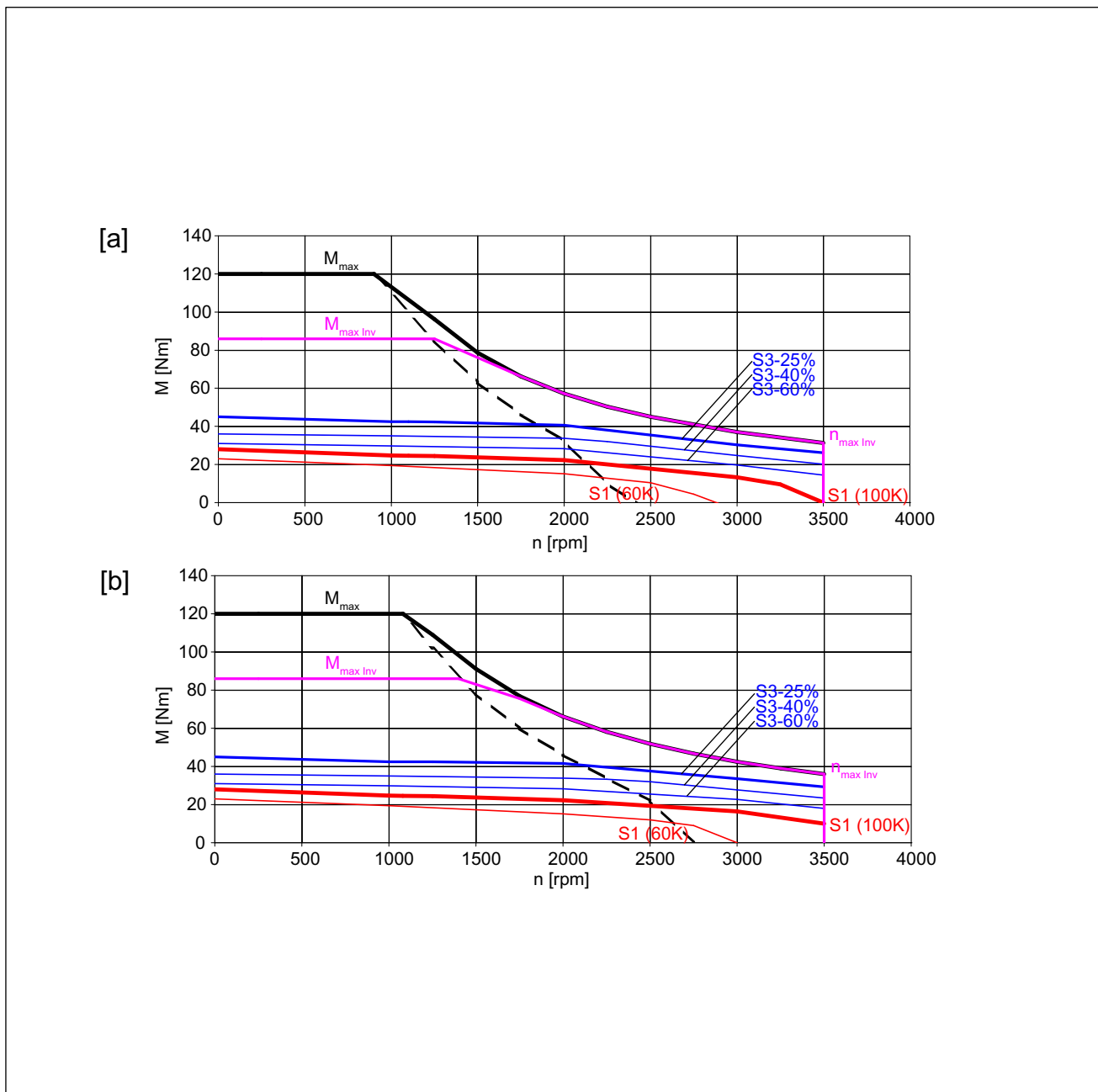

[a] SIMODRIVE 611 (UE), $V_{line} = 400 \text{ V}$, $V_{mot} = 380 \text{ V}_{rms}$

[b] SIMODRIVE 611 (ER), $V_{line} = 400 \text{ V}$, $V_{mot} = 425 \text{ V}_{rms}$

The characteristic curves are only valid for optimized converter setting data

Figure 4-28 1FT7086-□AC7

4.2 Torque-speed characteristic

Table 4- 25 1FT7086-□AF7

Technical data	Code	Unit	Value
Configuration data			
Rated speed	n_N	rpm	3000
Number of poles	2p	---	10
Rated torque (100 K)	$M_N (100 K)$	Nm	18
Rated current (100 K)	$I_N (100 K)$	A	11
Static torque (60 K)	$M_0 (60 K)$	Nm	23
Static torque (100 K)	$M_0 (100 K)$	Nm	28
Stall current (60 K)	$I_0 (60 K)$	A	12.5
Stall current (100 K)	$I_0 (100 K)$	A	15.5
Moment of inertia (with brake)	J_{MotBr}	10^{-4} kgm^2	79
Moment of inertia (without brake)	J_{Mot}	10^{-4} kgm^2	63.6
Optimum operating point			
Optimum speed	n_{opt}	rpm	3000
Optimum power	P_{opt}	kW	5.65
Limiting data			
Max. permissible speed (mech.)	$n_{max \text{ mech}}$	rpm	8000
Max. permissible speed (inverter)	$n_{max \text{ Inv}}$	rpm	5100
Maximum torque	M_{max}	Nm	120
Maximum current	I_{max}	A	78
Physical constants			
Torque constant	k_T	Nm/A	1.81
Voltage constant	k_E	V/1000 rpm	114
Winding resistance at 20 °C	R_{St}	Ω	0.23
Rotating field inductance	L_D	mH	4
Electrical time constant	T_{el}	ms	17
Mechanical time constant	T_{mech}	ms	1.3
Thermal time constant	T_{th}	min	60
Shaft torsional stiffness	C_t	Nm/rad	57000
Weight with brake	m_{MotBr}	kg	31.8
Weight without brake	m_{Mot}	kg	27.5

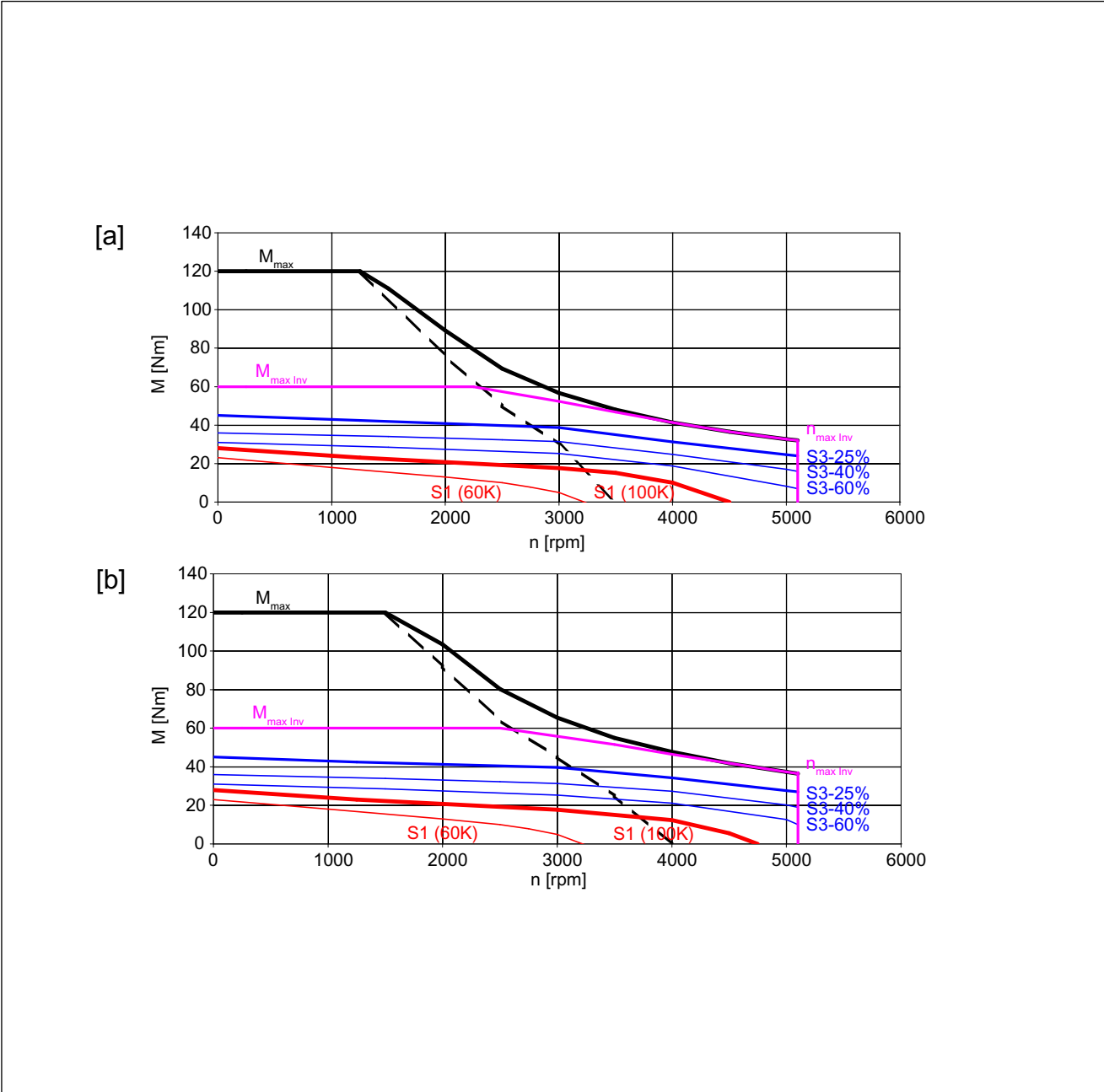

[a] SIMODRIVE 611 (UE), $V_{line} = 400 \text{ V}$, $V_{mot} = 380 \text{ V}_{rms}$

[b] SIMODRIVE 611 (ER), $V_{line} = 400 \text{ V}$, $V_{mot} = 425 \text{ V}_{rms}$

The characteristic curves are only valid for optimized inverter setting data

Figure 4-29 1FT7086-□AF7

4.2 Torque-speed characteristic

Table 4- 26 1FT7086-□AH7

Technical data	Code	Unit	Value
Configuration data			
Rated speed	n_N	rpm	4500
Number of poles	2p	---	10
Rated torque (100 K)	$M_N (100\text{ K})$	Nm	10
Rated current (100 K)	$I_N (100\text{ K})$	A	10
Static torque (60 K)	$M_0 (60\text{ K})$	Nm	23
Static torque (100 K)	$M_0 (100\text{ K})$	Nm	28
Stall current (60 K)	$I_0 (60\text{ K})$	A	18
Stall current (100 K)	$I_0 (100\text{ K})$	A	22.4
Moment of inertia (with brake)	J_{MotBr}	10^{-4} kgm^2	79
Moment of inertia (without brake)	J_{Mot}	10^{-4} kgm^2	63.6
Optimum operating point			
Optimum speed	n_{opt}	rpm	4500
Optimum power	P_{opt}	kW	4.71
Limiting data			
Max. permissible speed (mech.)	$n_{max\ mech}$	rpm	8000
Max. permissible speed (inverter)	$n_{max\ inv}$	rpm	7200
Maximum torque	M_{max}	Nm	120
Maximum current	I_{max}	A	110
Physical constants			
Torque constant	k_T	Nm/A	1.25
Voltage constant	k_E	V/1000 rpm	80
Winding resistance at 20 °C	R_{St}	Ω	0.11
Rotating field inductance	L_D	mH	2
Electrical time constant	T_{el}	ms	18
Mechanical time constant	T_{mech}	ms	1.3
Thermal time constant	T_{th}	min	60
Shaft torsional stiffness	C_t	Nm/rad	57000
Weight with brake	m_{MotBr}	kg	31.8
Weight without brake	m_{Mot}	kg	27.5

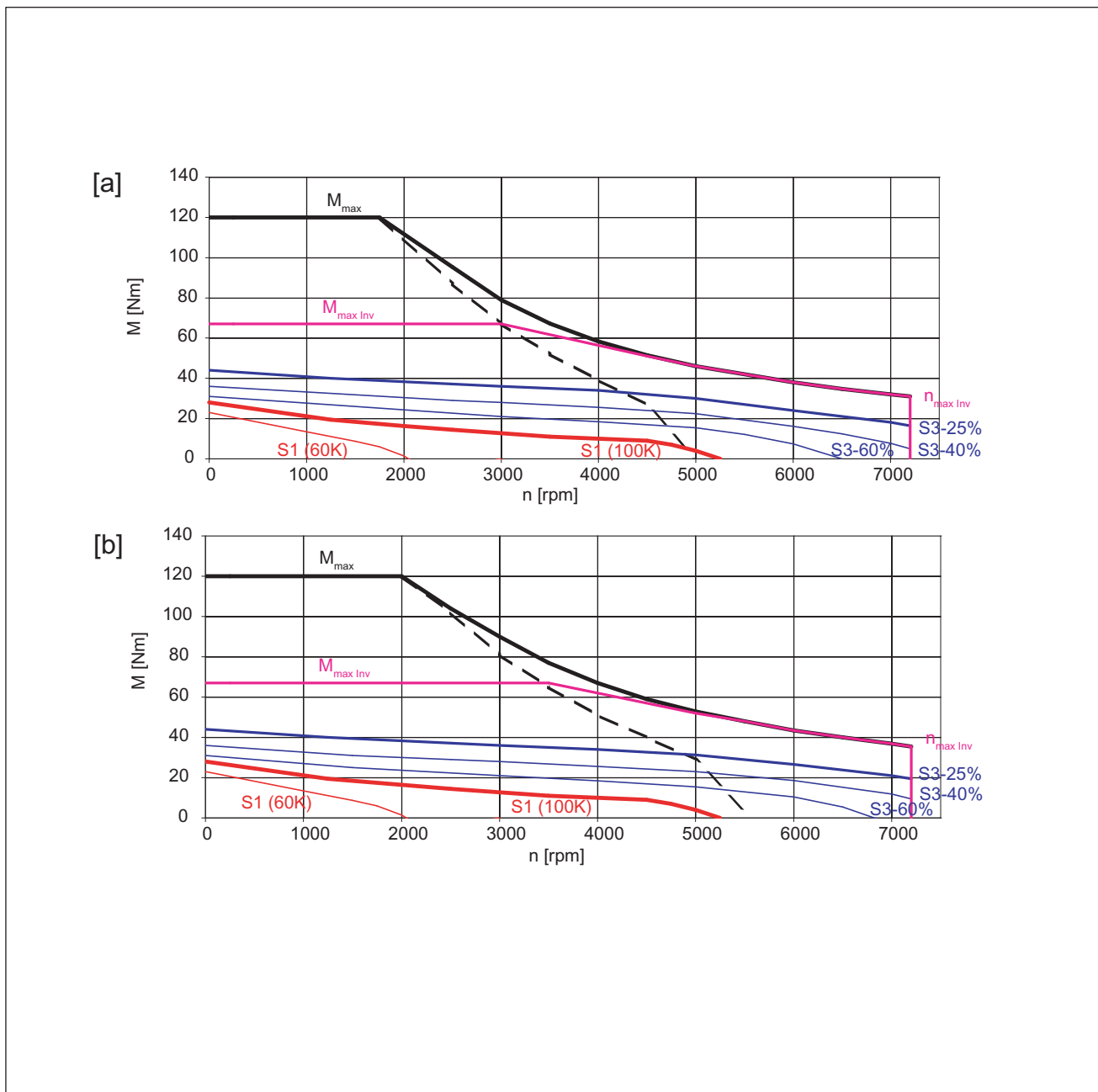

[a] SIMODRIVE 611 (UE), $V_{line} = 400 V$, $V_{mot} = 380 V_{rms}$

[b] SIMODRIVE 611 (ER), $V_{line} = 400 V$, $V_{mot} = 425 V_{rms}$

The characteristic curves are only valid for optimized inverter setting data

Figure 4-30 1FT7086-□AH7

4.2 Torque-speed characteristic

Table 4- 27 1FT7102-□AB7

Technical data	Code	Unit	Value
Configuration data			
Rated speed	n_N	rpm	1500
Number of poles	2p	---	10
Rated torque (100 K)	$M_N (100 K)$	Nm	26
Rated current (100 K)	$I_N (100 K)$	A	8
Static torque (60 K)	$M_0 (60 K)$	Nm	25
Static torque (100 K)	$M_0 (100 K)$	Nm	30
Stall current (60 K)	$I_0 (60 K)$	A	7.5
Stall current (100 K)	$I_0 (100 K)$	A	9
Moment of inertia (with brake)	J_{MotBr}	10^{-4} kgm^2	119
Moment of inertia (without brake)	J_{Mot}	10^{-4} kgm^2	91.4
Optimum operating point			
Optimum speed	n_{opt}	rpm	1500
Optimum power	P_{opt}	kW	4.08
Limiting data			
Max. permissible speed (mech.)	$n_{max \text{ mech}}$	rpm	6000
Max. permissible speed (inverter)	$n_{max \text{ Inv}}$	rpm	2680
Maximum torque	M_{max}	Nm	120
Maximum current	I_{max}	A	45
Physical constants			
Torque constant	k_T	Nm/A	3.33
Voltage constant	k_E	V/1000 rpm	216
Winding resistance at 20 °C	R_{St}	Ω	0.59
Rotating field inductance	L_D	mH	12.5
Electrical time constant	T_{el}	ms	21
Mechanical time constant	T_{mech}	ms	1.5
Thermal time constant	T_{th}	min	70
Shaft torsional stiffness	C_t	Nm/rad	124000
Weight with brake	m_{MotBr}	kg	32.3
Weight without brake	m_{Mot}	kg	26.1

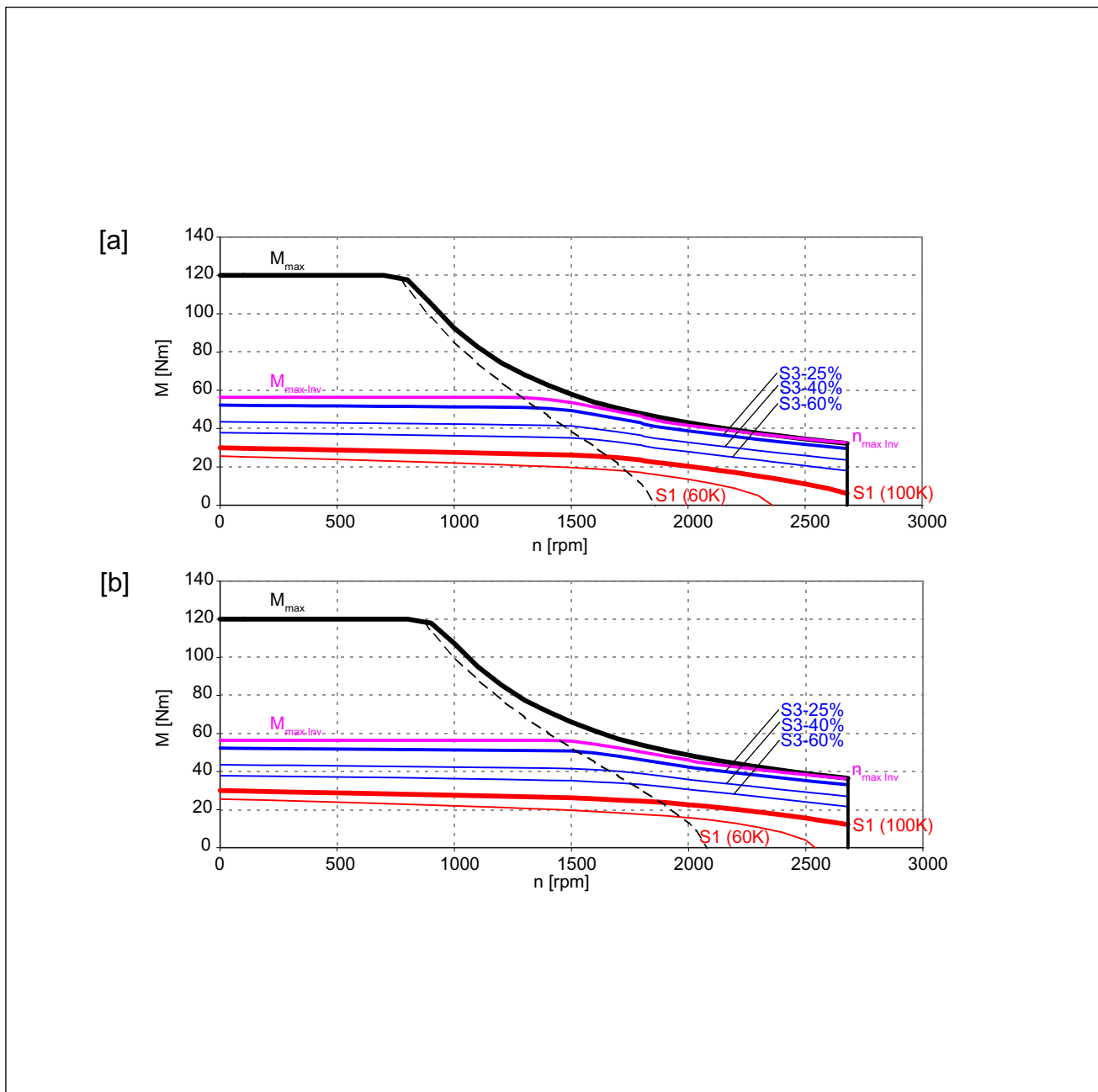
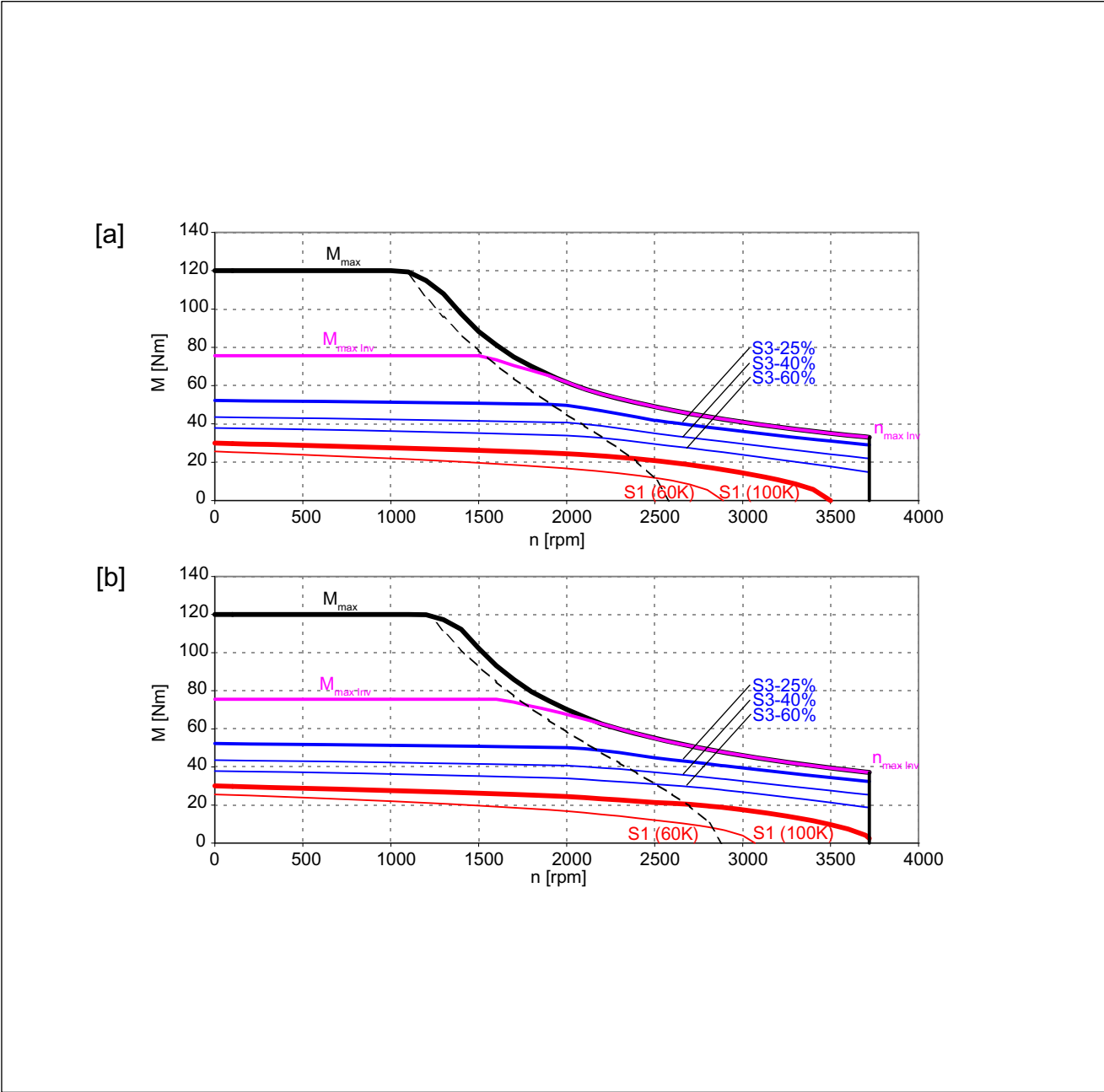

Figure 4-31 1FT7102-□AB7

4.2 Torque-speed characteristic

Table 4- 28 1FT7102-□AC7

Technical data	Code	Unit	Value
Configuration data			
Rated speed	n_N	rpm	2000
Number of poles	2p	---	10
Rated torque (100 K)	$M_N (100 K)$	Nm	24
Rated current (100 K)	$I_N (100 K)$	A	10
Static torque (60 K)	$M_0 (60 K)$	Nm	25
Static torque (100 K)	$M_0 (100 K)$	Nm	30
Stall current (60 K)	$I_0 (60 K)$	A	10.5
Stall current (100 K)	$I_0 (100 K)$	A	12.5
Moment of inertia (with brake)	J_{MotBr}	10^{-4} kgm^2	119
Moment of inertia (without brake)	J_{Mot}	10^{-4} kgm^2	91.4
Optimum operating point			
Optimum speed	n_{opt}	rpm	2000
Optimum power	P_{opt}	kW	5.03
Limiting data			
Max. permissible speed (mech.)	$n_{max \text{ mech}}$	rpm	6000
Max. permissible speed (inverter)	$n_{max \text{ Inv}}$	rpm	3800
Maximum torque	M_{max}	Nm	120
Maximum current	I_{max}	A	64
Physical constants			
Torque constant	k_T	Nm/A	2.40
Voltage constant	k_E	V/1000 rpm	152
Winding resistance at 20 °C	R_{St}	Ω	0.3
Rotating field inductance	L_D	mH	6.2
Electrical time constant	T_{el}	ms	21
Mechanical time constant	T_{mech}	ms	1.4
Thermal time constant	T_{th}	min	70
Shaft torsional stiffness	C_t	Nm/rad	124000
Weight with brake	m_{MotBr}	kg	32.3
Weight without brake	m_{Mot}	kg	26.1



[a] SIMODRIVE 611 (UE), $V_{line} = 400\text{ V}$, $V_{mot} = 380\text{ V}_{rms}$

[b] SIMODRIVE 611 (ER), $V_{line} = 400\text{ V}$, $V_{mot} = 425\text{ V}_{rms}$

The characteristic curves are only valid for optimized inverter setting data

Figure 4-32 1FT7102-□AC7

4.2 Torque-speed characteristic

Table 4- 29 1FT7102-□AF7

Technical data	Code	Unit	Value
Configuration data			
Rated speed	n_N	rpm	3000
Number of poles	2p	---	10
Rated torque (100 K)	$M_N (100\text{ K})$	Nm	20
Rated current (100 K)	$I_N (100\text{ K})$	A	12
Static torque (60 K)	$M_0 (60\text{ K})$	Nm	25
Static torque (100 K)	$M_0 (100\text{ K})$	Nm	30
Stall current (60 K)	$I_0 (60\text{ K})$	A	15
Stall current (100 K)	$I_0 (100\text{ K})$	A	18
Moment of inertia (with brake)	J_{MotBr}	10^{-4} kgm^2	119
Moment of inertia (without brake)	J_{Mot}	10^{-4} kgm^2	91.4
Optimum operating point			
Optimum speed	n_{opt}	rpm	3000
Optimum power	P_{opt}	kW	6.28
Limiting data			
Max. permissible speed (mech.)	$n_{max\ mech}$	rpm	6000
Max. permissible speed (inverter)	$n_{max\ inv}$	rpm	5360
Maximum torque	M_{max}	Nm	120
Maximum current	I_{max}	A	90
Physical constants			
Torque constant	k_T	Nm/A	1.67
Voltage constant	k_E	V/1000 rpm	108
Winding resistance at 20 °C	R_{St}	Ω	0.15
Rotating field inductance	L_D	mH	3.1
Electrical time constant	T_{el}	ms	21
Mechanical time constant	T_{mech}	ms	1.5
Thermal time constant	T_{th}	min	70
Shaft torsional stiffness	C_t	Nm/rad	124000
Weight with brake	m_{MotBr}	kg	32.3
Weight without brake	m_{Mot}	kg	26.1

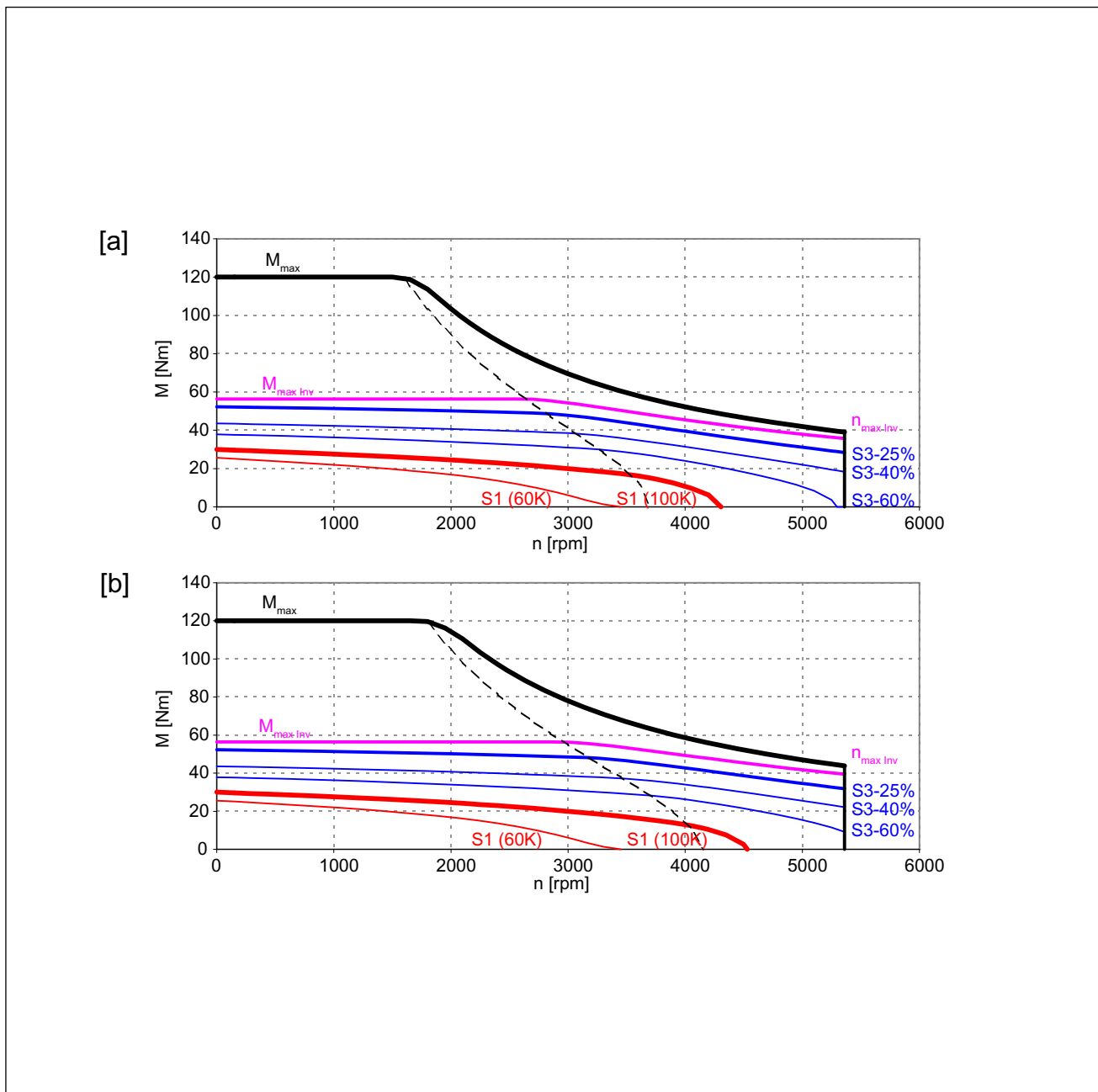

[a] SIMODRIVE 611 (UE), $V_{line} = 400 \text{ V}$, $V_{mot} = 380 \text{ V}_{rms}$

[b] SIMODRIVE 611 (ER), $V_{line} = 400 \text{ V}$, $V_{mot} = 425 \text{ V}_{rms}$

The characteristic curves are only valid for optimized inverter setting data

Figure 4-33 1FT7102-□AF7

4.2 Torque-speed characteristic

Table 4- 30 1FT7105-□AB7

Technical data	Code	Unit	Value
Configuration data			
Rated speed	n_N	rpm	1500
Number of poles	2p	---	10
Rated torque (100 K)	$M_N (100\text{ K})$	Nm	42
Rated current (100 K)	$I_N (100\text{ K})$	A	13
Static torque (60 K)	$M_0 (60\text{ K})$	Nm	41
Static torque (100 K)	$M_0 (100\text{ K})$	Nm	50
Stall current (60 K)	$I_0 (60\text{ K})$	A	12
Stall current (100 K)	$I_0 (100\text{ K})$	A	15
Moment of inertia (with brake)	J_{MotBr}	10^{-4} kgm^2	206
Moment of inertia (without brake)	J_{Mot}	10^{-4} kgm^2	178
Optimum operating point			
Optimum speed	n_{opt}	rpm	1500
Optimum power	P_{opt}	kW	6.60
Limiting data			
Max. permissible speed (mech.)	$n_{max\ mech}$	rpm	6000
Max. permissible speed (inverter)	$n_{max\ inv}$	rpm	2670
Maximum torque	M_{max}	Nm	200
Maximum current	I_{max}	A	67
Physical constants			
Torque constant	k_T	Nm/A	3.33
Voltage constant	k_E	V/1000 rpm	217
Winding resistance at 20 °C	R_{St}	Ω	0.25
Rotating field inductance	L_D	mH	6.8
Electrical time constant	T_{el}	ms	27
Mechanical time constant	T_{mech}	ms	1.2
Thermal time constant	T_{th}	min	80
Shaft torsional stiffness	C_t	Nm/rad	107000
Weight with brake	m_{MotBr}	kg	50.4
Weight without brake	m_{Mot}	kg	44.2

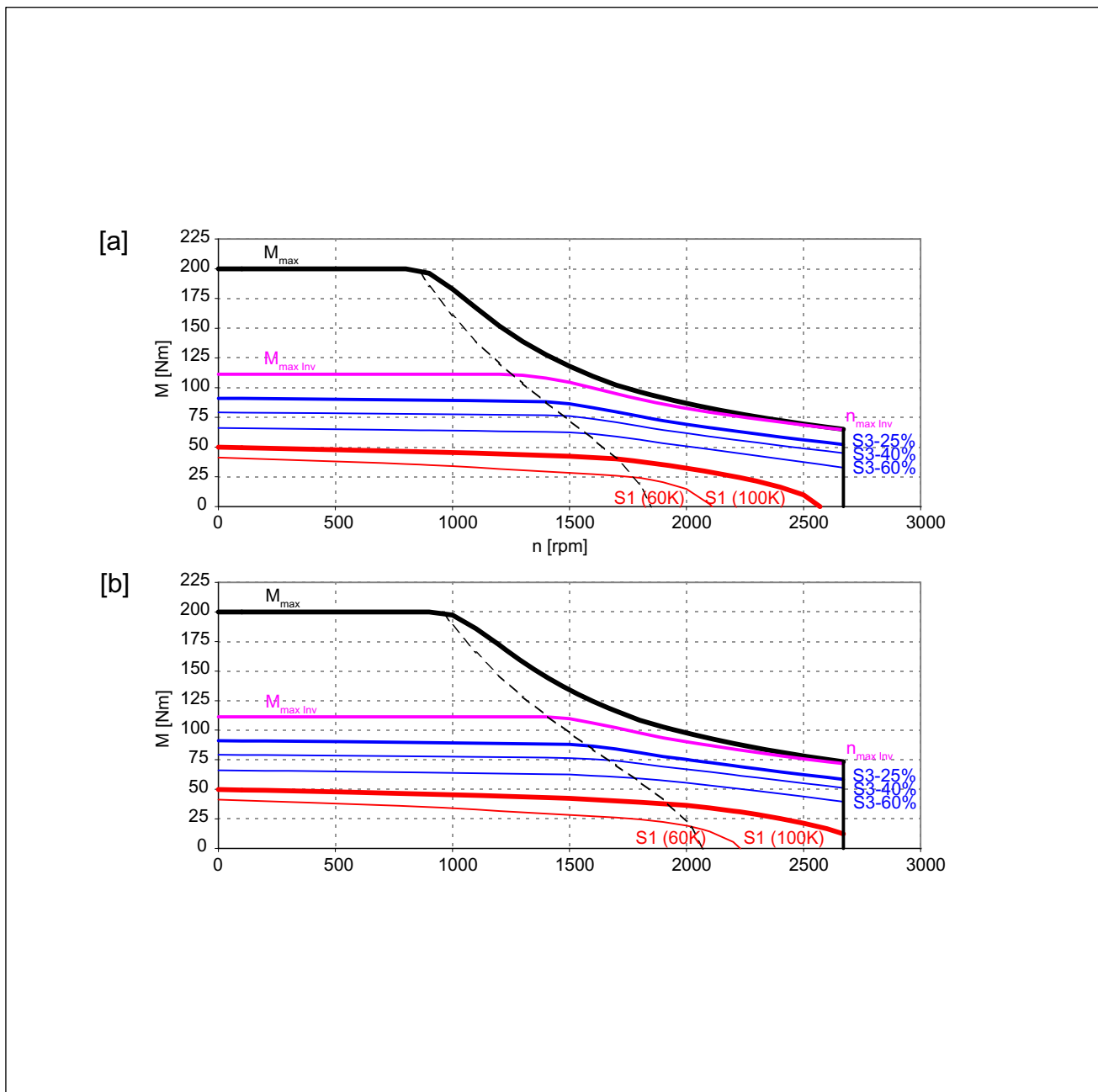

[a] SIMODRIVE 611 (UE), $V_{line} = 400 V$, $V_{mot} = 380 V_{rms}$

[b] SIMODRIVE 611 (ER), $V_{line} = 400 V$, $V_{mot} = 425 V_{rms}$

The characteristic curves are only valid for optimized inverter setting data

Figure 4-34 1FT7105-□AB7

4.2 Torque-speed characteristic

Table 4- 31 1FT7105-□AC7

Technical data	Code	Unit	Value
Configuration data			
Rated speed	n_N	rpm	2000
Number of poles	2p	---	10
Rated torque (100 K)	$M_N (100\text{ K})$	Nm	38
Rated current (100 K)	$I_N (100\text{ K})$	A	15
Static torque (60 K)	$M_0 (60\text{ K})$	Nm	41
Static torque (100 K)	$M_0 (100\text{ K})$	Nm	50
Stall current (60 K)	$I_0 (60\text{ K})$	A	15
Stall current (100 K)	$I_0 (100\text{ K})$	A	18
Moment of inertia (with brake)	J_{MotBr}	10^{-4} kgm^2	206
Moment of inertia (without brake)	J_{Mot}	10^{-4} kgm^2	178
Optimum operating point			
Optimum speed	n_{opt}	rpm	2000
Optimum power	P_{opt}	kW	7.96
Limiting data			
Max. permissible speed (mech.)	$n_{max\ mech}$	rpm	6000
Max. permissible speed (inverter)	$n_{max\ inv}$	rpm	3350
Maximum torque	M_{max}	Nm	200
Maximum current	I_{max}	A	84
Physical constants			
Torque constant	k_T	Nm/A	2.78
Voltage constant	k_E	V/1000 rpm	173
Winding resistance at 20 °C	R_{St}	Ω	0.15
Rotating field inductance	L_D	mH	4.3
Electrical time constant	T_{el}	ms	29
Mechanical time constant	T_{mech}	ms	1.0
Thermal time constant	T_{th}	min	80
Shaft torsional stiffness	C_t	Nm/rad	107000
Weight with brake	m_{MotBr}	kg	50.4
Weight without brake	m_{Mot}	kg	44.2

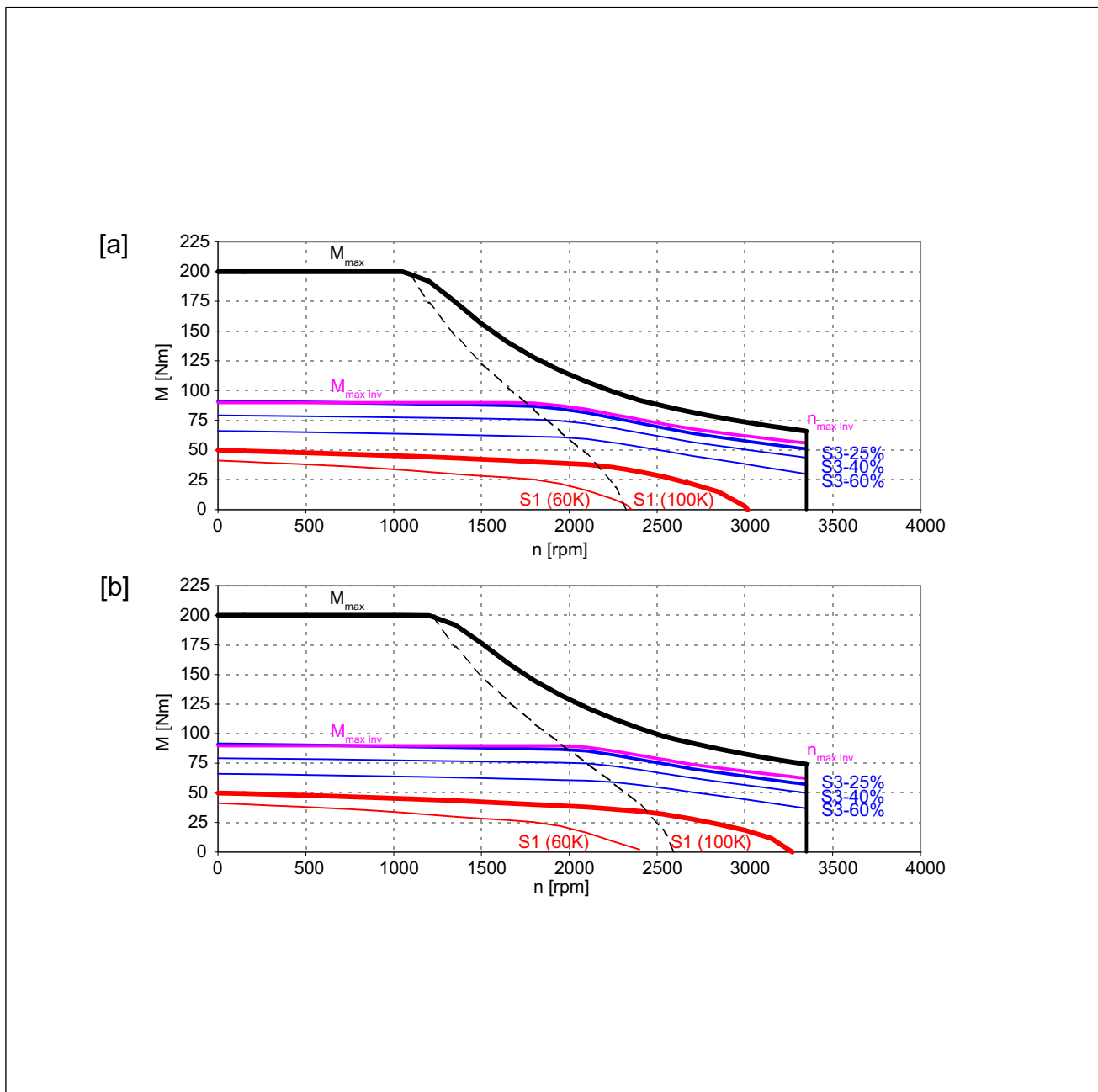

[a] SIMODRIVE 611 (UE), $V_{line} = 400 V$, $V_{mot} = 380 V_{rms}$

[b] SIMODRIVE 611 (ER), $V_{line} = 400 V$, $V_{mot} = 425 V_{rms}$

The characteristic curves are only valid for optimized inverter setting data

Figure 4-35 1FT7105-□AC7

4.2 Torque-speed characteristic

Table 4- 32 1FT7105-□AF7

Technical data	Code	Unit	Value
Configuration data			
Rated speed	n_N	rpm	3000
Number of poles	2p	---	10
Rated torque (100 K)	$M_N (100\text{ K})$	Nm	28
Rated current (100 K)	$I_N (100\text{ K})$	A	15
Static torque (60 K)	$M_0 (60\text{ K})$	Nm	41
Static torque (100 K)	$M_0 (100\text{ K})$	Nm	50
Stall current (60 K)	$I_0 (60\text{ K})$	A	21
Stall current (100 K)	$I_0 (100\text{ K})$	A	26
Moment of inertia (with brake)	J_{MotBr}	10^{-4} kgm^2	206
Moment of inertia (without brake)	J_{Mot}	10^{-4} kgm^2	178
Optimum operating point			
Optimum speed	n_{opt}	rpm	3000
Optimum power	P_{opt}	kW	8.8
Limiting data			
Max. permissible speed (mech.)	$n_{max\ mech}$	rpm	6000
Max. permissible speed (inverter)	$n_{max\ Inv}$	rpm	4630
Maximum torque	M_{max}	Nm	200
Maximum current	I_{max}	A	116
Physical constants			
Torque constant	k_T	Nm/A	1.92
Voltage constant	k_E	V/1000 rpm	125
Winding resistance at 20 °C	R_{Str}	Ω	0.08
Rotating field inductance	L_D	mH	2.3
Electrical time constant	T_{el}	ms	29
Mechanical time constant	T_{mech}	ms	1.2
Thermal time constant	T_{th}	min	80
Shaft torsional stiffness	C_t	Nm/rad	107000
Weight with brake	m_{MotBr}	kg	50.4
Weight without brake	m_{Mot}	kg	44.2

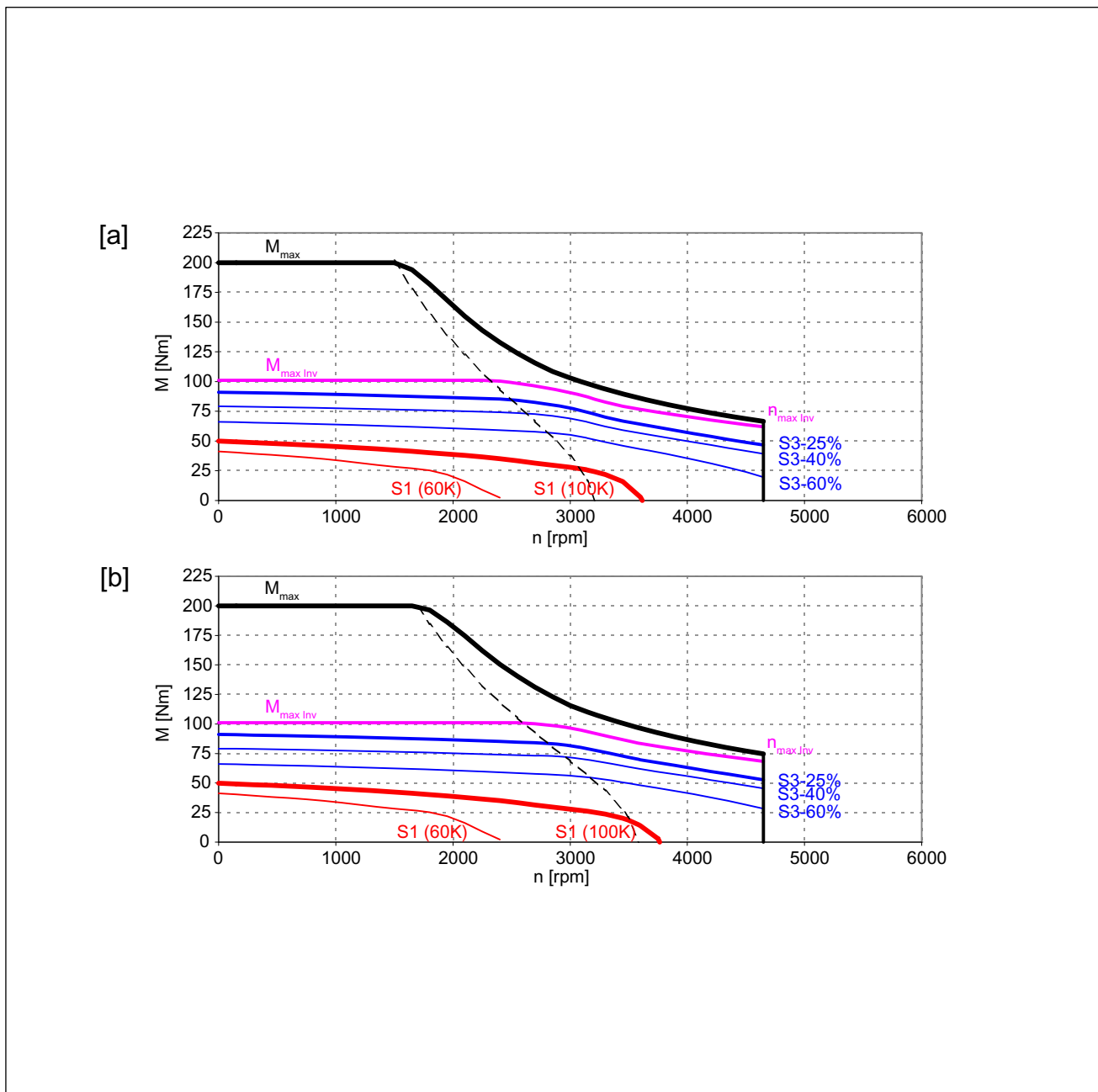

[a] SIMODRIVE 611 (UE), $V_{line} = 400 V$, $V_{mot} = 380 V_{rms}$

[b] SIMODRIVE 611 (ER), $V_{line} = 400 V$, $V_{mot} = 425 V_{rms}$

The characteristic curves are only valid for optimized inverter setting data

Figure 4-36 1FT7105-□AF7

4.2 Torque-speed characteristic

Table 4- 33 1FT7108-□AB7

Technical data	Code	Unit	Value
Engineering data			
Rated speed	n_N	RPM	1500
Number of poles	2p	---	10
Rated torque (100 K)	$M_N (100\text{ K})$	Nm	61
Rated current (100 K)	$I_N (100\text{ K})$	A	16
Stall torque (60 K)	$M_0 (60\text{ K})$	Nm	58
Stall torque (100 K)	$M_0 (100\text{ K})$	Nm	70
Stall current (60 K)	$I_0 (60\text{ K})$	A	15
Stall current (100 K)	$I_0 (100\text{ K})$	A	18
Moment of inertia (with brake)	J_{MotBr}	10^{-4} kgm^2	276
Moment of inertia (without brake)	J_{mot}	10^{-4} kgm^2	248
Optimum operating point			
Optimum speed	n_{opt}	RPM	1500
Optimum power	P_{opt}	kW	9,58
Limit data			
Max. permissible speed (mech.)	$n_{max\ mech.}$	RPM	6000
Max. permissible speed (converter)	$n_{max\ conv}$	RPM	2390
Max. torque	M_{max}	Nm	280
Maximum current	I_{max}	A	87
Physical constants			
Torque constant	k_T	Nm/A	3,89
Voltage constant	k_E	V/1000 RPM	242
Winding resistance at 20° C	R_{ph}	Ω	0,2
Rotating field inductance	L_D	mH	6
Electrical time constant	T_{el}	ms	30
Mechanical time constant	T_{mech}	ms	1,0
Thermal time constant	T_{th}	min	95
Shaft torsional stiffness	C_t	Nm/rad	95700
Weight with brake	m_{MotBr}	kg	65,1
Weight without brake	m_{Mot}	kg	59

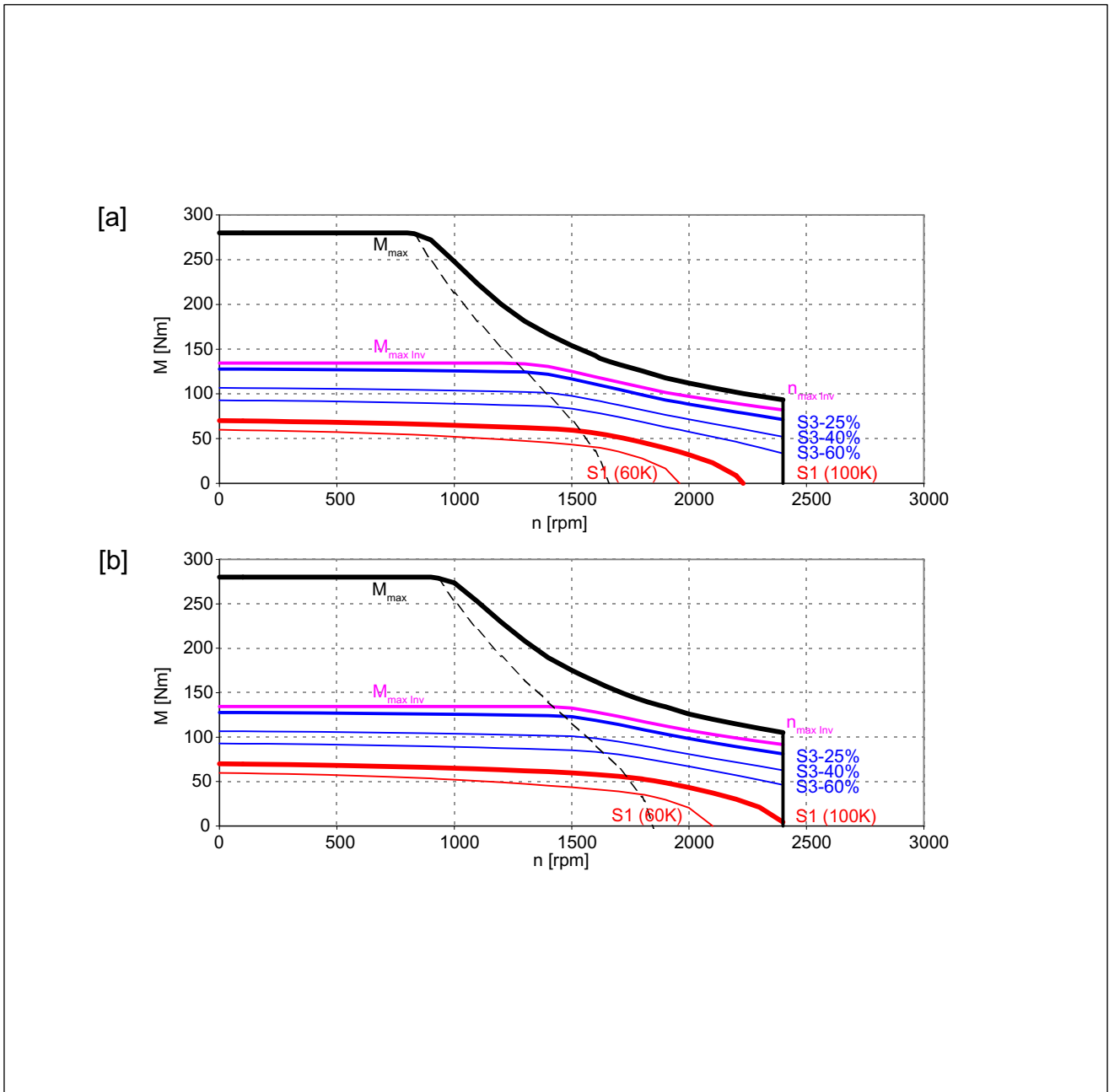

[a] SIMODRIVE 611 (UE), $U_{line} = 400 \text{ V}$, $U_{mot} = 380 \text{ V}_{rms}$

[b] SIMODRIVE 611 (ER), $U_{line} = 400 \text{ V}$, $U_{mot} = 425 \text{ V}_{rms}$

The characteristic curves are only valid for optimized converter setting data

Figure 4-37 1FT7108-□AB7

4.2 Torque-speed characteristic

Table 4- 34 1FT7108-□AC7

Technical data	Code	Unit	Value
Engineering data			
Rated speed	n_N	RPM	2000
Number of poles	2p	---	10
Rated torque (100 K)	$M_N (100 K)$	Nm	50
Rated current (100 K)	$I_N (100 K)$	A	18
Stall torque (60 K)	$M_0 (60 K)$	Nm	58
Stall torque (100 K)	$M_0 (100 K)$	Nm	70
Stall current (60 K)	$I_0 (60 K)$	A	21
Stall current (100 K)	$I_0 (100 K)$	A	25
Moment of inertia (with brake)	J_{MotBr}	10^{-4} kgm^2	276
Moment of inertia (without brake)	J_{mot}	10^{-4} kgm^2	248
Optimum operating point			
Optimum speed	n_{opt}	RPM	2000
Optimum power	P_{opt}	kW	10,5
Limit data			
Max. permissible speed (mech.)	$n_{max \text{ mech.}}$	RPM	6000
Max. permissible speed (converter)	$n_{max \text{ conv}}$	RPM	3310
Max. torque	M_{max}	Nm	280
Maximum current	I_{max}	A	120
Physical constants			
Torque constant	k_T	Nm/A	2,80
Voltage constant	k_E	V/1000 RPM	175
Winding resistance at 20° C	R_{ph}	Ω	0,11
Rotating field inductance	L_D	mH	3,1
Electrical time constant	T_{el}	ms	28
Mechanical time constant	T_{mech}	ms	1,0
Thermal time constant	T_{th}	min	95
Shaft torsional stiffness	C_t	Nm/rad	95700
Weight with brake	m_{MotBr}	kg	65,1
Weight without brake	m_{Mot}	kg	59

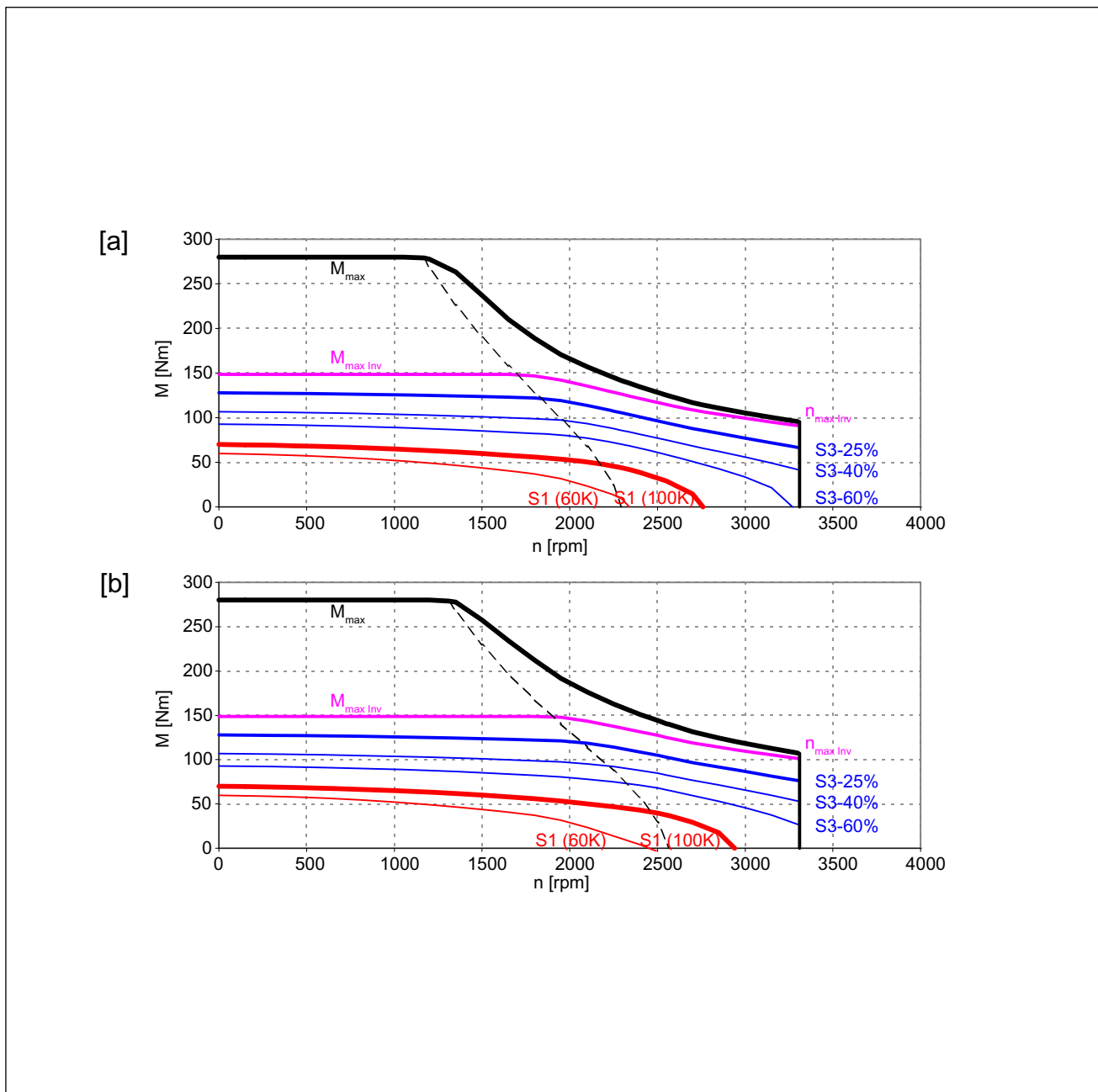

[a] SIMODRIVE 611 (UE), $V_{line} = 400 \text{ V}$, $V_{mot} = 380 \text{ V}_{rms}$

[b] SIMODRIVE 611 (ER), $V_{line} = 400 \text{ V}$, $V_{mot} = 425 \text{ V}_{rms}$

The characteristic curves are only valid for optimized converter setting data

Figure 4-38 1FT7108-□AC7

4.2 Torque-speed characteristic

Table 4- 35 1FT7108-□AF7

Technical data	Code	Unit	Value
Engineering data			
Rated speed	n_N	RPM	3000
Number of poles	2p	---	10
Rated torque (100 K)	$M_N (100 K)$	Nm	20
Rated current (100 K)	$I_N (100 K)$	A	12
Stall torque (60 K)	$M_0 (60 K)$	Nm	58
Stall torque (100 K)	$M_0 (100 K)$	Nm	70
Stall current (60 K)	$I_0 (60 K)$	A	28
Stall current (100 K)	$I_0 (100 K)$	A	36
Moment of inertia (with brake)	J_{MotBr}	10^{-4} kgm^2	276
Moment of inertia (without brake)	J_{mot}	10^{-4} kgm^2	248
Optimum operating point			
Optimum speed	n_{opt}	RPM	2000
Optimum power	P_{opt}	kW	8,17
Limit data			
Max. permissible speed (mech.)	$n_{max \text{ mech.}}$	RPM	6000
Max. permissible speed (converter)	$n_{max \text{ conv}}$	RPM	4500
Max. torque	M_{max}	Nm	280
Maximum current	I_{max}	A	165
Physical constants			
Torque constant	k_T	Nm/A	1,94
Voltage constant	k_E	V/1000 RPM	128
Winding resistance at 20° C	R_{ph}	Ω	0,065
Rotating field inductance	L_D	mH	1,7
Electrical time constant	T_{el}	ms	26
Mechanical time constant	T_{mech}	ms	1,3
Thermal time constant	T_{th}	min	95
Shaft torsional stiffness	C_t	Nm/rad	95700
Weight with brake	m_{MotBr}	kg	65,1
Weight without brake	m_{Mot}	kg	59

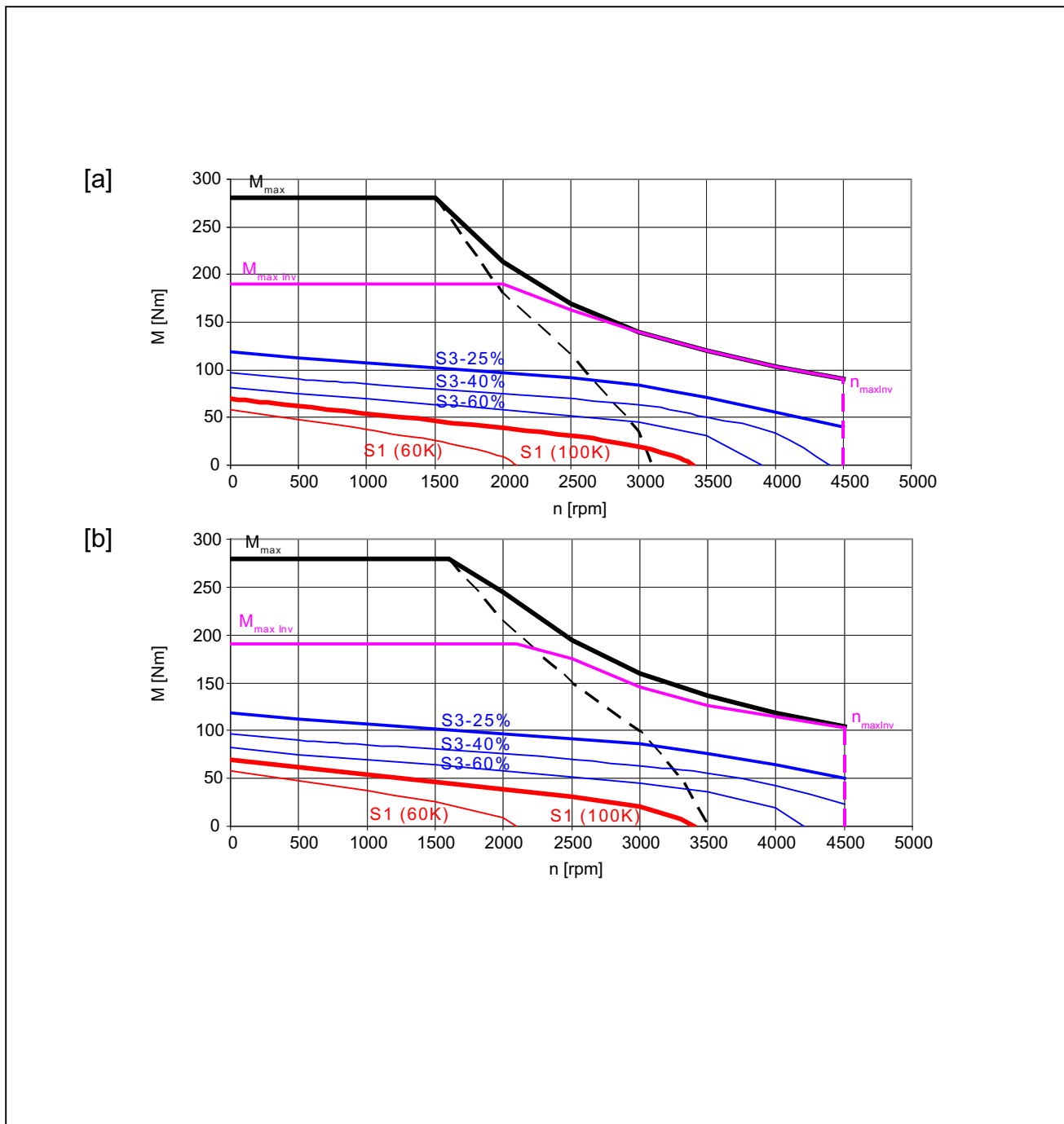

[a] SIMODRIVE 611 (UE), $V_{line} = 400$ V, $V_{mot} = 380$ V_{rms}

[b] SIMODRIVE 611 (ER), $V_{line} = 400$ V, $V_{mot} = 425$ V_{rms}

The characteristic curves are only valid for optimized converter setting data

Figure 4-39 1FT7108-□AF

4.2 Torque-speed characteristic

4.2.2 1FT7 synchronous motors with forced ventilation

Table 4- 36 1FT7084-5SC7

Technical data	Code	Unit	Value
Configuration data			
Rated speed	n_N	rpm	2000
Number of poles	$2p$	---	10
Rated torque (100 K)	$M_N (100\text{ K})$	Nm	24
Rated current (100 K)	$I_N (100\text{ K})$	A	13.5
Static torque (60 K)	$M_0 (60\text{ K})$	Nm	21.5
Static torque (100 K)	$M_0 (100\text{ K})$	Nm	27
Stall current (60 K)	$I_0 (60\text{ K})$	A	12
Stall current (100 K)	$I_0 (100\text{ K})$	A	15
Moment of inertia (with brake)	J_{MotBr}	10^{-4} kgm^2	60
Moment of inertia (without brake)	J_{Mot}	10^{-4} kgm^2	45
Optimum operating point			
Optimum speed	n_{opt}	rpm	2000
Optimum power	P_{opt}	kW	5.0
Limiting data			
Max. permissible speed (mech.)	$n_{max\ mech}$	rpm	8000
Max. permissible speed (inverter)	$n_{max\ Inv}$	rpm	5000
Maximum torque	M_{max}	Nm	81
Maximum current	I_{max}	A	55
Physical constants			
Torque constant	k_T	Nm/A	1.80
Voltage constant	k_E	V/1000 rpm	115
Winding resistance at 20 °C	R_{Str}	Ω	0.34
Rotating field inductance	L_D	mH	5.4
Electrical time constant	T_{el}	ms	16
Mechanical time constant	T_{mech}	ms	1.4
Thermal time constant	T_{th}	min	35
Shaft torsional stiffness	C_t	Nm/rad	65100
Weight with brake	m_{MotBr}	kg	29
Weight without brake	m_{Mot}	kg	25

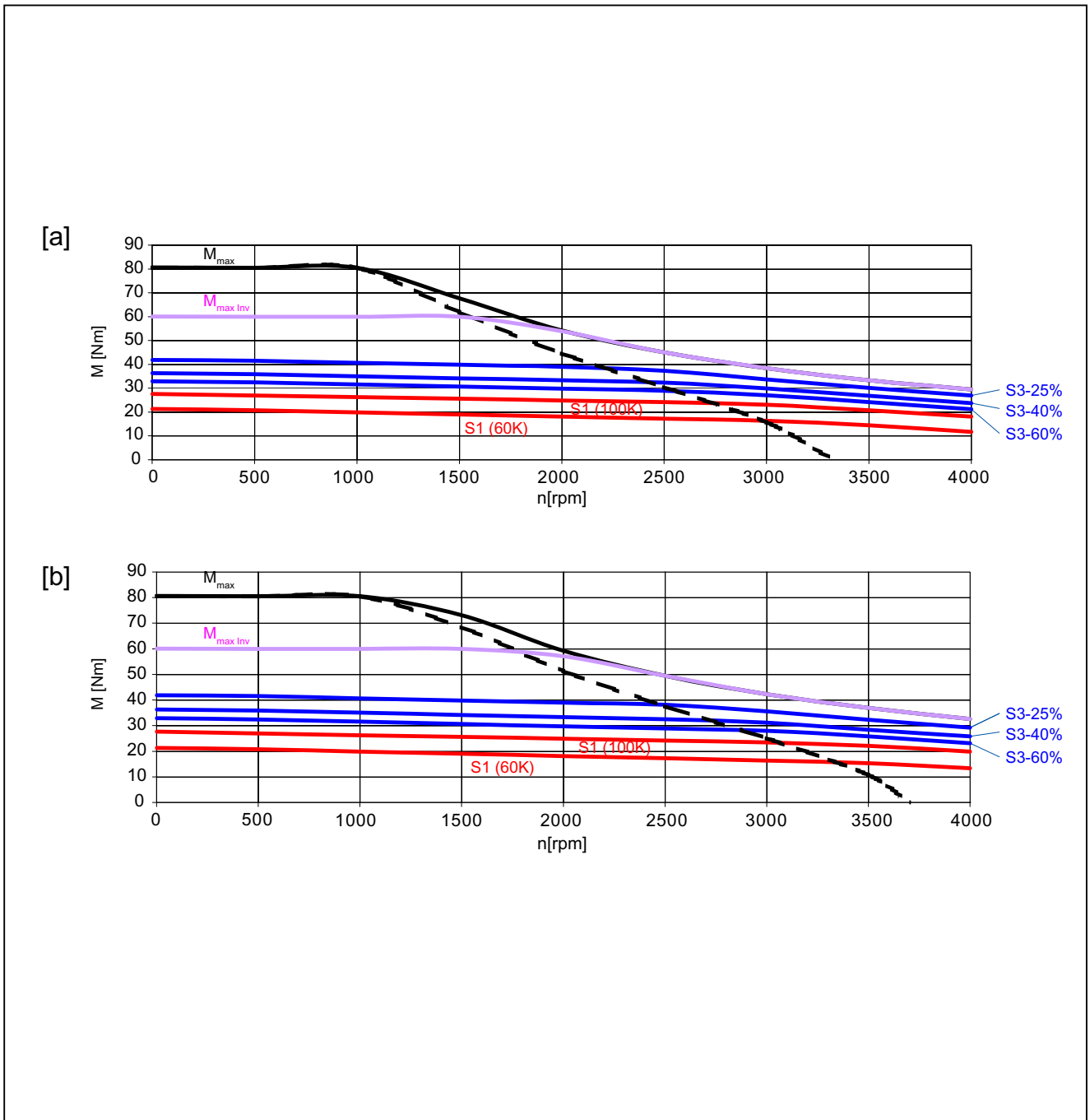

[a] SIMODRIVE 611 (UE) 400 V

[b] SIMODRIVE 611 (E/R) 400 V

The characteristic curves are only valid for optimized inverter setting data

Figure 4-40 1FT7084-5SC7

4.2 Torque-speed characteristic

Table 4- 37 1FT7084-5SF7

Technical data	Code	Unit	Value
Configuration data			
Rated speed	n_N	rpm	3000
Number of poles	2p	---	10
Rated torque (100 K)	$M_N (100\text{ K})$	Nm	23
Rated current (100 K)	$I_N (100\text{ K})$	A	18.5
Static torque (60 K)	$M_0 (60\text{ K})$	Nm	21.5
Static torque (100 K)	$M_0 (100\text{ K})$	Nm	27
Stall current (60 K)	$I_0 (60\text{ K})$	A	16.5
Stall current (100 K)	$I_0 (100\text{ K})$	A	21
Moment of inertia (with brake)	J_{MotBr}	10^{-4} kgm^2	60
Moment of inertia (without brake)	J_{Mot}	10^{-4} kgm^2	45
Optimum operating point			
Optimum speed	n_{opt}	rpm	3000
Optimum power	P_{opt}	kW	7.20
Limiting data			
Max. permissible speed (mech.)	$n_{max\ mech}$	rpm	8000
Max. permissible speed (inverter)	$n_{max\ Inv}$	rpm	7000
Maximum torque	M_{max}	Nm	81
Maximum current	I_{max}	A	77
Physical constants			
Torque constant	k_T	Nm/A	1.30
Voltage constant	k_E	V/1000 rpm	83
Winding resistance at 20 °C	R_{Str}	Ω	0.18
Rotating field inductance	L_D	mH	2.8
Electrical time constant	T_{el}	ms	16
Mechanical time constant	T_{mech}	ms	1.4
Thermal time constant	T_{th}	min	35
Shaft torsional stiffness	c_t	Nm/rad	65100
Weight with brake	m_{MotBr}	kg	29
Weight without brake	m_{Mot}	kg	25

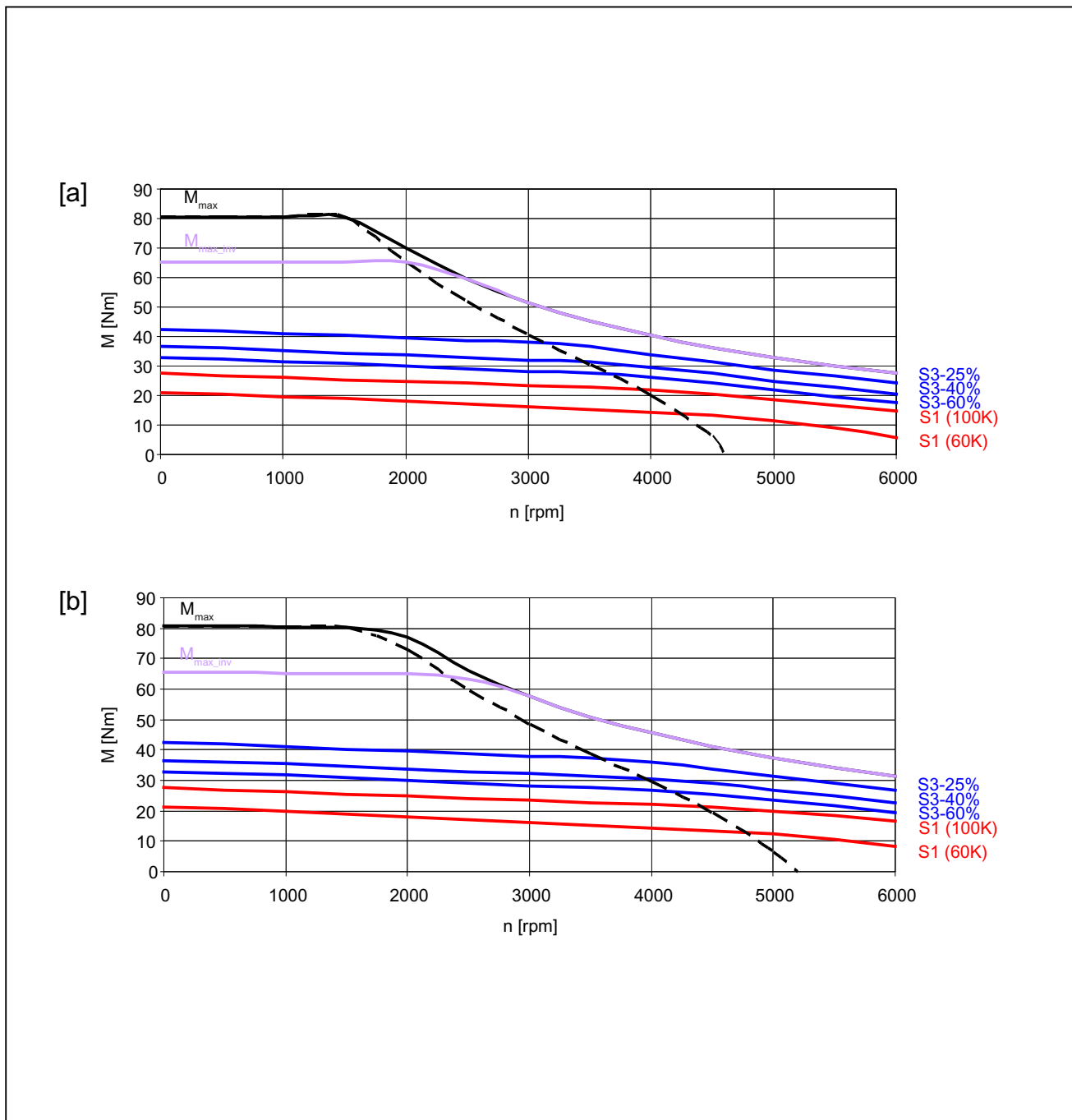

[a] SIMODRIVE 611 (UE) 400 V

[b] SIMODRIVE 611 (E/R) 400 V

The characteristic curves are only valid for optimized inverter setting data

Figure 4-41 1FT7084-5SF7

4.2 Torque-speed characteristic

Table 4- 38 1FT7084-5SH7

Technical data	Code	Unit	Value
Configuration data			
Rated speed	n_N	rpm	4500
Number of poles	2p	---	10
Rated torque (100 K)	$M_N (100\text{ K})$	Nm	21
Rated current (100 K)	$I_N (100\text{ K})$	A	24.5
Static torque (60 K)	$M_0 (60\text{ K})$	Nm	21.5
Static torque (100 K)	$M_0 (100\text{ K})$	Nm	27
Stall current (60 K)	$I_0 (60\text{ K})$	A	24
Stall current (100 K)	$I_0 (100\text{ K})$	A	30.5
Moment of inertia (with brake)	J_{MotBr}	10^{-4} kgm^2	60
Moment of inertia (without brake)	J_{Mot}	10^{-4} kgm^2	45
Optimum operating point			
Optimum speed	n_{opt}	rpm	4500
Optimum power	P_{opt}	kW	9.90
Limiting data			
Max. permissible speed (mech.)	$n_{max\ mech}$	rpm	8000
Max. permissible speed (inverter)	$n_{max\ Inv}$	rpm	8000
Maximum torque	M_{max}	Nm	81
Maximum current	I_{max}	A	114
Physical constants			
Torque constant	k_T	Nm/A	0.88
Voltage constant	k_E	V/1000 rpm	56
Winding resistance at 20 °C	R_{Str}	Ω	0.08
Rotating field inductance	L_D	mH	1.4
Electrical time constant	T_{el}	ms	18
Mechanical time constant	T_{mech}	ms	1.4
Thermal time constant	T_{th}	min	35
Shaft torsional stiffness	C_t	Nm/rad	65100
Weight with brake	m_{MotBr}	kg	29
Weight without brake	m_{Mot}	kg	25

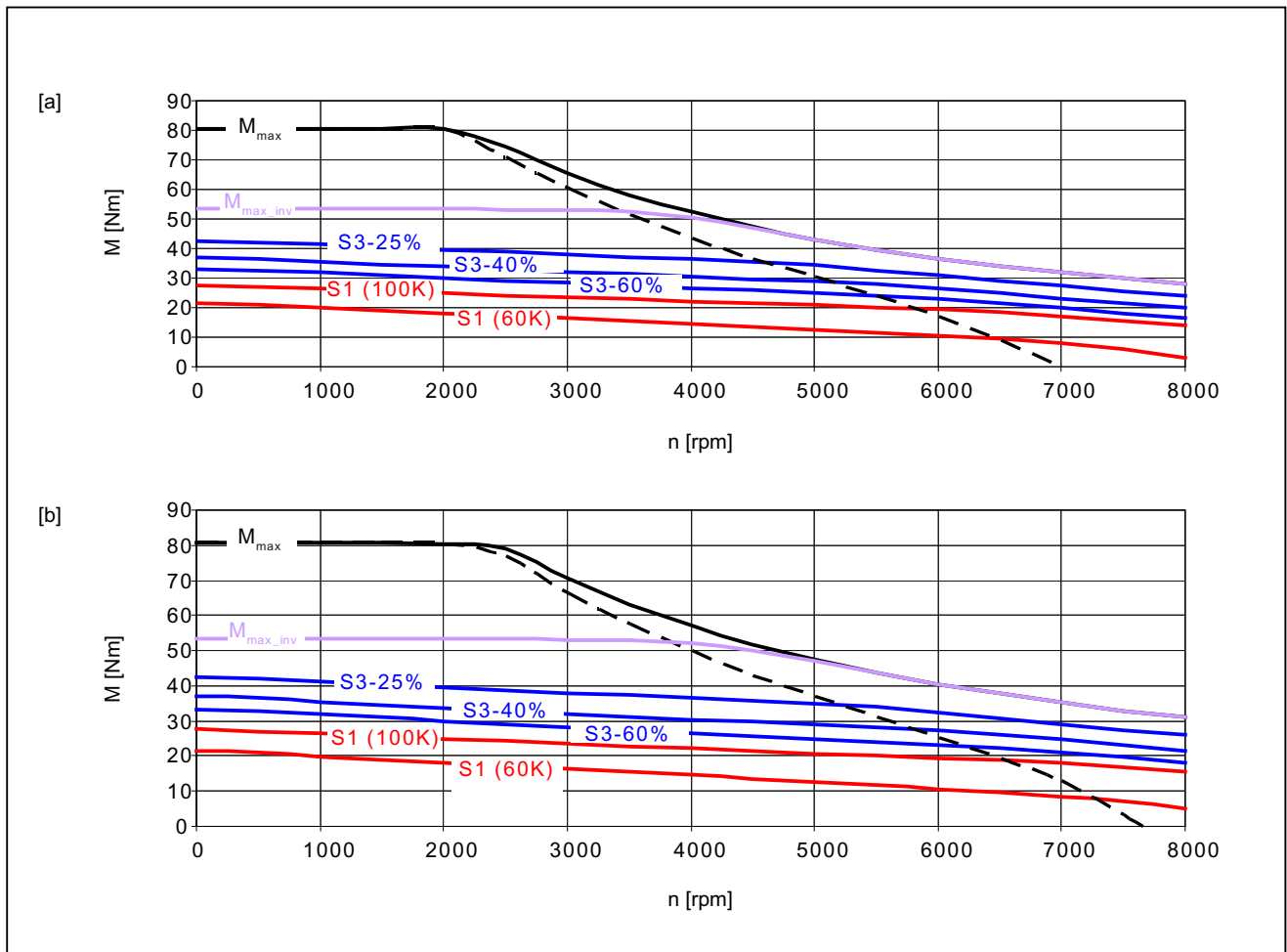

[a] SIMODRIVE 611 (UE) 400 V

[b] SIMODRIVE 611 (E/R) 400 V

The characteristic curves are only valid for optimized inverter setting data

Figure 4-42 1FT7084-5SH7

Table 4- 39 1FT7086-5SC7

Technical data	Code	Unit	Value
Configuration data			
Rated speed	n_N	rpm	2000
Number of poles	$2p$	---	10
Rated torque (100 K)	$M_N(100\text{ K})$	Nm	32
Rated current (100 K)	$I_N(100\text{ K})$	A	17
Static torque (60 K)	$M_0(60\text{ K})$	Nm	30
Static torque (100 K)	$M_0(100\text{ K})$	Nm	36
Stall current (60 K)	$I_0(60\text{ K})$	A	16
Stall current (100 K)	$I_0(100\text{ K})$	A	19.5
Moment of inertia (with brake)	J_{MotBr}	10^{-4} kgm^2	79
Moment of inertia (without brake)	J_{Mot}	10^{-4} kgm^2	64

Technical data and characteristics

4.2 Torque-speed characteristic

Technical data	Code	Unit	Value
Optimum operating point			
Optimum speed	n_{opt}	rpm	2000
Optimum power	P_{opt}	kW	6.7
Limiting data			
Max. permissible speed (mech.)	$n_{max\ mech}$	rpm	8000
Max. permissible speed (inverter)	$n_{max\ Inv}$	rpm	4900
Maximum torque	M_{max}	Nm	120
Maximum current	I_{max}	A	74
Physical constants			
Torque constant	k_T	Nm/A	1.86
Voltage constant	k_E	V/1000 rpm	119
Winding resistance at 20 °C	R_{Str}	Ω	0.24
Rotating field inductance	L_D	mH	4.4
Electrical time constant	T_{el}	ms	18
Mechanical time constant	T_{mech}	ms	1.3
Thermal time constant	T_{th}	min	40
Shaft torsional stiffness	C_t	Nm/rad	57000
Weight with brake	m_{MotBr}	kg	32
Weight without brake	m_{Mot}	kg	36

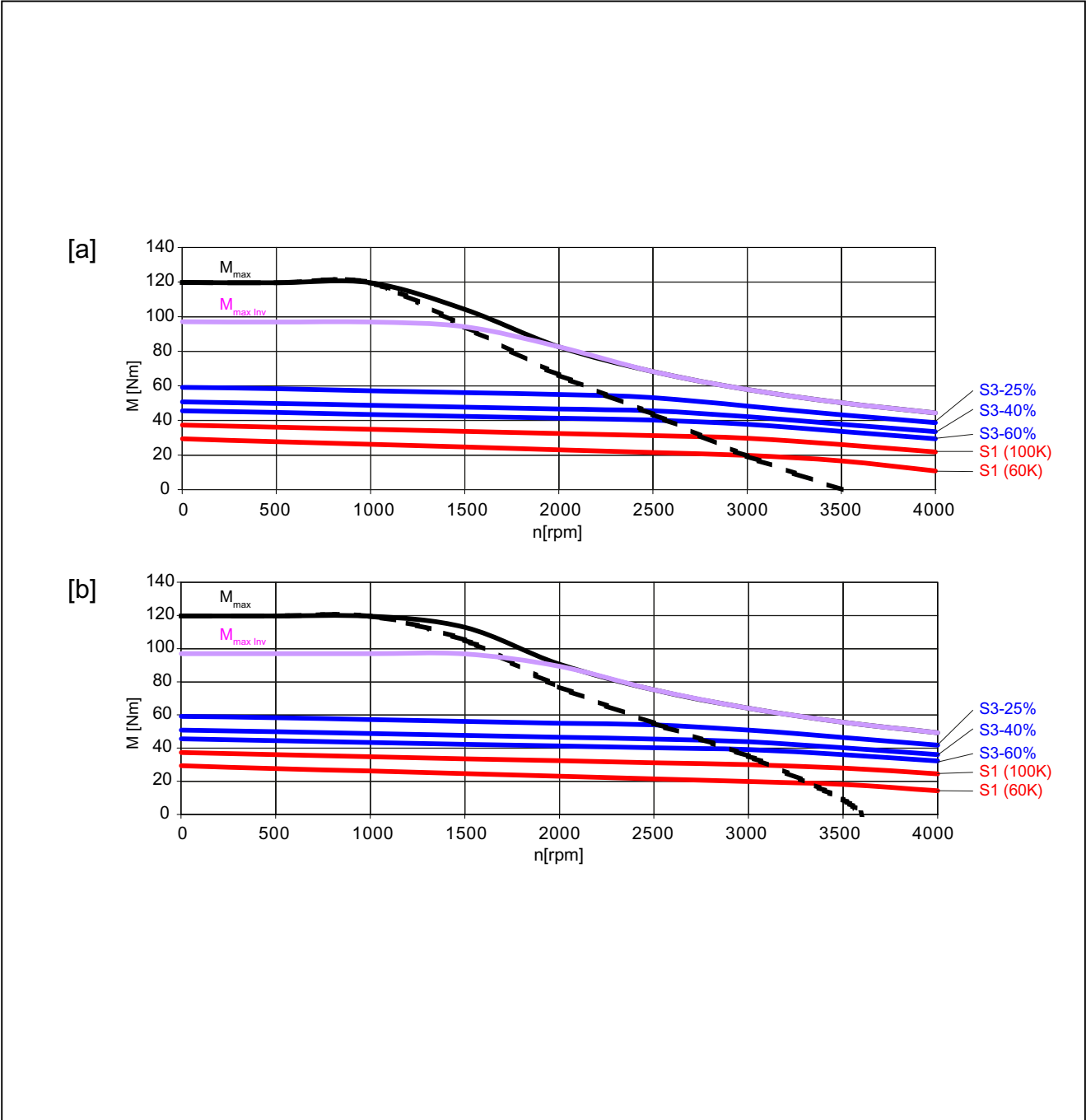

[a] SIMODRIVE 611 (UE) 400 V

[b] SIMODRIVE 611 (E/R) 400 V

The characteristic curves are only valid for optimized inverter setting data

Figure 4-43 1FT7086-5SC7

4.2 Torque-speed characteristic

Table 4- 40 1FT7086-5SF7

Technical data	Code	Unit	Value
Configuration data			
Rated speed	n_N	rpm	3000
Number of poles	$2p$	---	10
Rated torque (100 K)	$M_N (100 K)$	Nm	29
Rated current (100 K)	$I_N (100 K)$	A	24
Static torque (60 K)	$M_0 (60 K)$	Nm	30
Static torque (100 K)	$M_0 (100 K)$	Nm	36
Stall current (60 K)	$I_0 (60 K)$	A	24
Stall current (100 K)	$I_0 (100 K)$	A	29
Moment of inertia (with brake)	J_{MotBr}	10^{-4} kgm ²	79
Moment of inertia (without brake)	J_{Mot}	10^{-4} kgm ²	64
Optimum operating point			
Optimum speed	n_{opt}	rpm	3000
Optimum power	P_{opt}	kW	9.1
Limiting data			
Max. permissible speed (mech.)	$n_{max mech}$	rpm	8000
Max. permissible speed (inverter)	$n_{max Inv}$	rpm	7200
Maximum torque	M_{max}	Nm	120
Maximum current	I_{max}	A	110
Physical constants			
Torque constant	k_T	Nm/A	1.25
Voltage constant	k_E	V/1000 rpm	80
Winding resistance at 20 °C	R_{Str}	Ω	0.11
Rotating field inductance	L_D	mH	2
Electrical time constant	T_{el}	ms	18
Mechanical time constant	T_{mech}	ms	1.4
Thermal time constant	T_{th}	min	40
Shaft torsional stiffness	C_t	Nm/rad	57000
Weight with brake	m_{MotBr}	kg	32
Weight without brake	m_{Mot}	kg	36

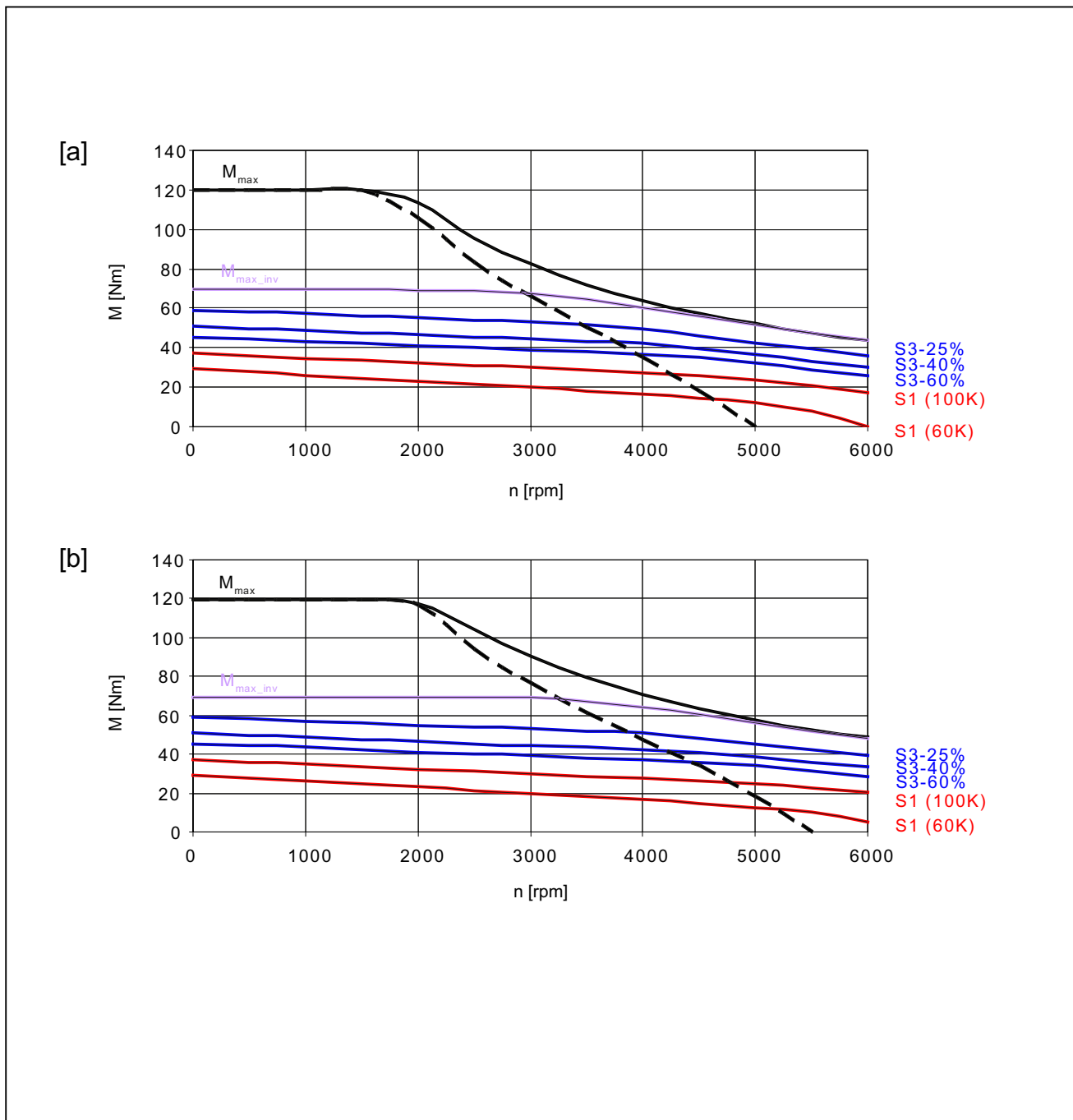

[a] SIMODRIVE 611 (UE) 400 V

[b] SIMODRIVE 611 (E/R) 400 V

The characteristic curves are only valid for optimized inverter setting data

Figure 4-44 1FT7086-5SF7

4.2 Torque-speed characteristic

Table 4- 41 1FT7086-5SH7

Technical data	Code	Unit	Value
Configuration data			
Rated speed	n_N	rpm	4500
Number of poles	2p	---	10
Rated torque (100 K)	$M_N (100\text{ K})$	Nm	25
Rated current (100 K)	$I_N (100\text{ K})$	A	25
Static torque (60 K)	$M_0 (60\text{ K})$	Nm	30
Static torque (100 K)	$M_0 (100\text{ K})$	Nm	36
Stall current (60 K)	$I_0 (60\text{ K})$	A	28
Stall current (100 K)	$I_0 (100\text{ K})$	A	34
Moment of inertia (with brake)	J_{MotBr}	10^{-4} kgm^2	79
Moment of inertia (without brake)	J_{Mot}	10^{-4} kgm^2	64
Optimum operating point			
Optimum speed	n_{opt}	rpm	4500
Optimum power	P_{opt}	kW	11.8
Limiting data			
Max. permissible speed (mech.)	$n_{max\ mech}$	rpm	8000
Max. permissible speed (inverter)	$n_{max\ Inv}$	rpm	8000
Maximum torque	M_{max}	Nm	120
Maximum current	I_{max}	A	131
Physical constants			
Torque constant	k_T	Nm/A	1.05
Voltage constant	k_E	V/1000 rpm	67
Winding resistance at 20 °C	R_{Str}	Ω	0.08
Rotating field inductance	L_D	mH	1.4
Electrical time constant	T_{el}	ms	18
Mechanical time constant	T_{mech}	ms	1.4
Thermal time constant	T_{th}	min	40
Shaft torsional stiffness	c_t	Nm/rad	57000
Weight with brake	m_{MotBr}	kg	32
Weight without brake	m_{Mot}	kg	36

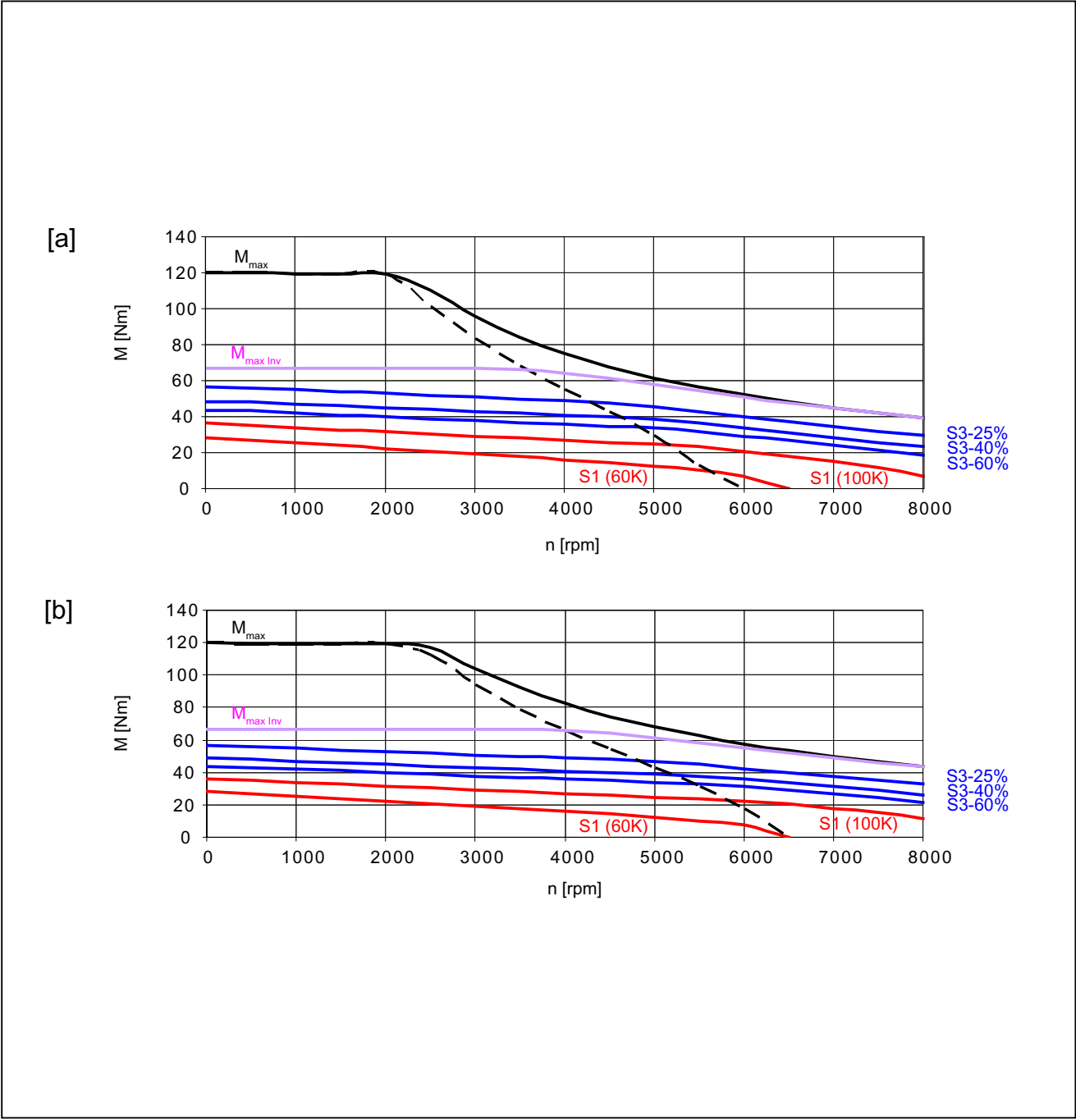

[a] SIMODRIVE 611 (UE) 400 V

[b] SIMODRIVE 611 (E/R) 400 V

The characteristic curves are only valid for optimized inverter setting data

Figure 4-45 1FT7086-5SH7

4.2 Torque-speed characteristic

Table 4- 42 1FT7105-5SC7

Technical data	Code	Unit	Value
Configuration data			
Rated speed	n_N	rpm	2000
Number of poles	$2p$	---	10
Rated torque (100 K)	$M_N (100 K)$	Nm	56
Rated current (100 K)	$I_N (100 K)$	A	29
Static torque (60 K)	$M_0 (60 K)$	Nm	51
Static torque (100 K)	$M_0 (100 K)$	Nm	65
Stall current (60 K)	$I_0 (60 K)$	A	24
Stall current (100 K)	$I_0 (100 K)$	A	31
Moment of inertia (with brake)	J_{MotBr}	10^{-4} kgm ²	206
Moment of inertia (without brake)	J_{Mot}	10^{-4} kgm ²	178
Optimum operating point			
Optimum speed	n_{opt}	rpm	2000
Optimum power	P_{opt}	kW	11.7
Limiting data			
Max. permissible speed (mech.)	$n_{max mech}$	rpm	6000
Max. permissible speed (inverter)	$n_{max Inv}$	rpm	4250
Maximum torque	M_{max}	Nm	200
Maximum current	I_{max}	A	107
Physical constants			
Torque constant	k_T	Nm/A	2.13
Voltage constant	k_E	V/1000 rpm	136
Winding resistance at 20 °C	R_{Str}	Ω	0.1
Rotating field inductance	L_D	mH	2.7
Electrical time constant	T_{el}	ms	27
Mechanical time constant	T_{mech}	ms	1.2
Thermal time constant	T_{th}	min	50
Shaft torsional stiffness	C_t	Nm/rad	107000
Weight with brake	m_{MotBr}	kg	56
Weight without brake	m_{Mot}	kg	50

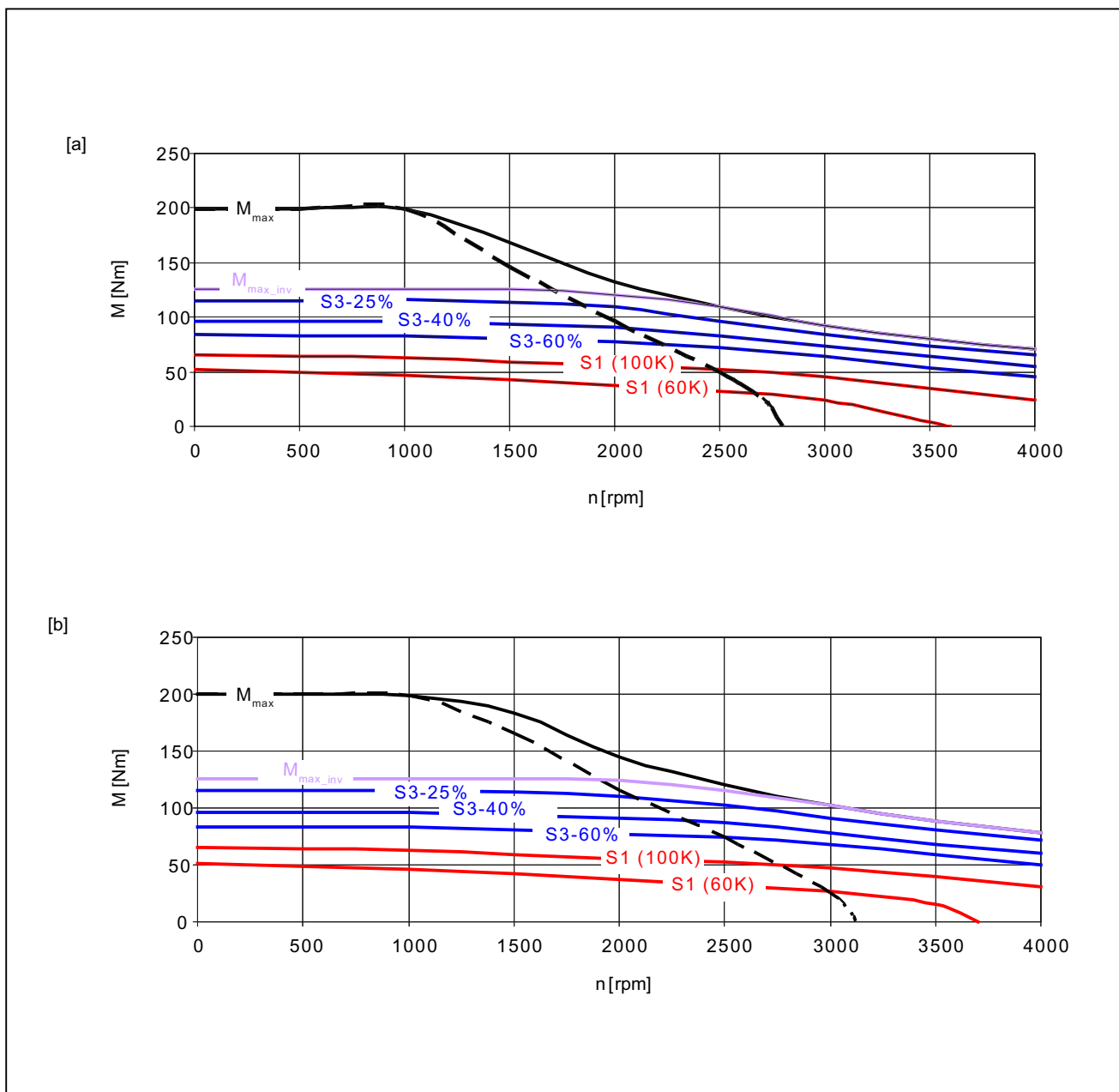

[a] SIMODRIVE 611 (UE) 400 V

[b] SIMODRIVE 611 (E/R) 400 V

The characteristic curves are only valid for optimized inverter setting data

Figure 4-46 1FT7105-5SC7

4.2 Torque-speed characteristic

Table 4- 43 1FT7105-5SF7

Technical data	Code	Unit	Value
Configuration data			
Rated speed	n_N	rpm	3000
Number of poles	$2p$	---	10
Rated torque (100 K)	$M_N (100 K)$	Nm	48
Rated current (100 K)	$I_N (100 K)$	A	35
Static torque (60 K)	$M_0 (60 K)$	Nm	51
Static torque (100 K)	$M_0 (100 K)$	Nm	65
Stall current (60 K)	$I_0 (60 K)$	A	36
Stall current (100 K)	$I_0 (100 K)$	A	45
Moment of inertia (with brake)	J_{MotBr}	10^{-4} kgm ²	206
Moment of inertia (without brake)	J_{Mot}	10^{-4} kgm ²	178
Optimum operating point			
Optimum speed	n_{opt}	rpm	3000
Optimum power	P_{opt}	kW	15.1
Limiting data			
Max. permissible speed (mech.)	$n_{max mech}$	rpm	6000
Max. permissible speed (inverter)	$n_{max Inv}$	rpm	6000
Maximum torque	M_{max}	Nm	200
Maximum current	I_{max}	A	158
Physical constants			
Torque constant	k_T	Nm/A	1.43
Voltage constant	k_E	V/1000 rpm	92
Winding resistance at 20 °C	R_{Str}	Ω	0.05
Rotating field inductance	L_D	mH	1.25
Electrical time constant	T_{el}	ms	25
Mechanical time constant	T_{mech}	ms	1.3
Thermal time constant	T_{th}	min	50
Shaft torsional stiffness	C_t	Nm/rad	107000
Weight with brake	m_{MotBr}	kg	56
Weight without brake	m_{Mot}	kg	50

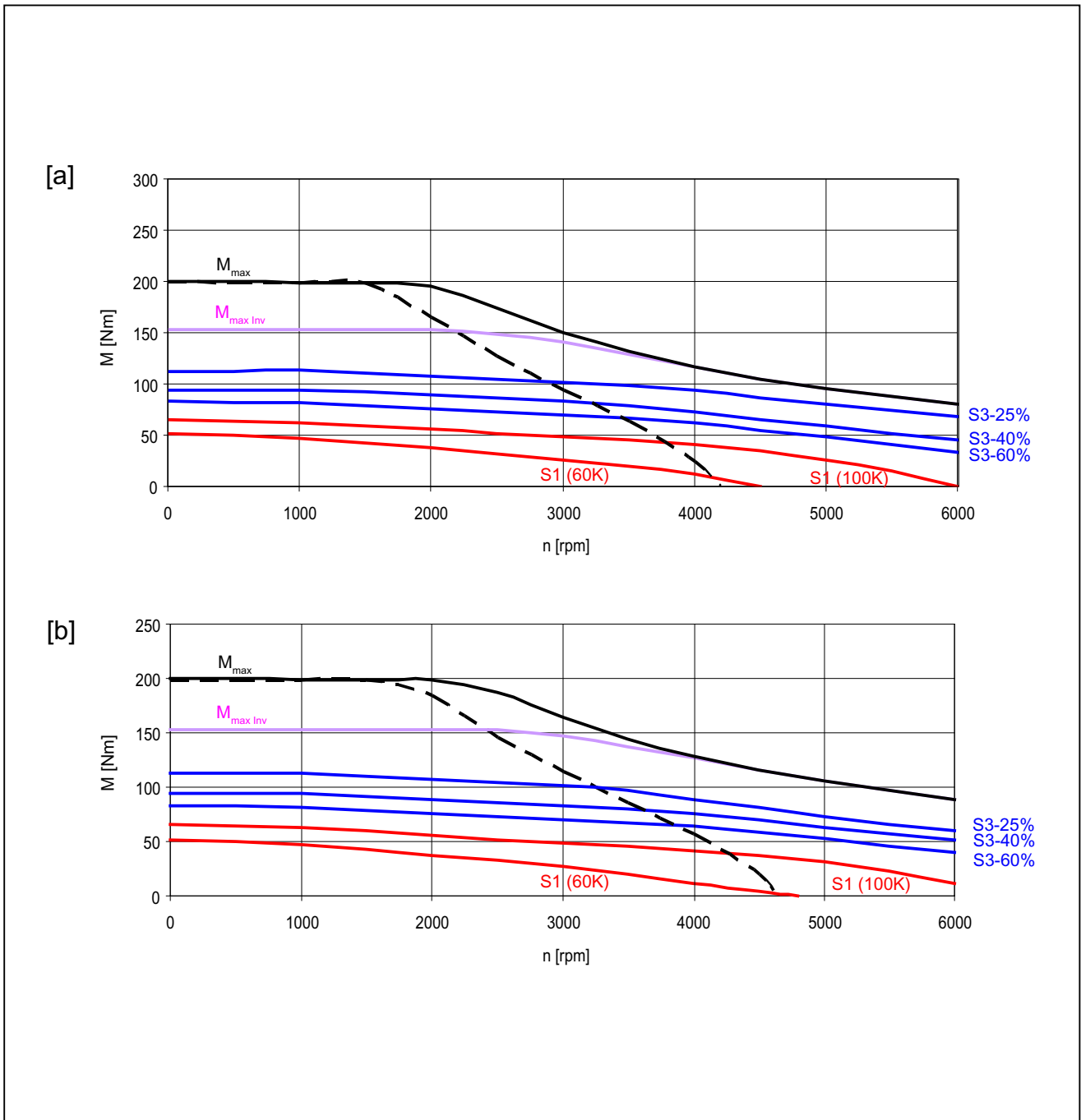

[a] SIMODRIVE 611 (UE) 400 V

[b] SIMODRIVE 611 (E/R) 400 V

The characteristic curves are only valid for optimized inverter setting data

Figure 4-47 1FT7105-5SF7

4.2 Torque-speed characteristic

4.2.3 1FT7 synchronous motors, water cooling

Table 4- 44 1FT7062-5WF7

Technical data	Code	Unit	Value
Configuration data			
Rated speed	n_N	rpm	3000
Number of poles	$2p$	---	10
Rated torque (100 K)	$M_N (100 K)$	Nm	10
Rated current (100 K)	$I_N (100 K)$	A	7.8
Static torque (60 K)	$M_0 (60 K)$	Nm	8
Static torque (100 K)	$M_0 (100 K)$	Nm	10
Stall current (60 K)	$I_0 (60 K)$	A	5.9
Stall current (100 K)	$I_0 (100 K)$	A	7.4
Moment of inertia (with brake)	J_{MotBr}	10^{-4} kgm ²	10.6
Moment of inertia (without brake)	J_{Mot}	10^{-4} kgm ²	8.1
Optimum operating point			
Optimum speed	n_{opt}	rpm	3000
Optimum power	P_{opt}	kW	3.14
Limiting data			
Max. permissible speed (mech.)	$n_{max mech}$	rpm	9000
Max. permissible speed (inverter)	$n_{max Inv}$	rpm	6700
Maximum torque	M_{max}	Nm	26
Maximum current	I_{max}	A	27.2
Physical constants			
Torque constant	k_T	Nm/A	1.35
Voltage constant	k_E	V/1000 rpm	86
Winding resistance at 20 °C	R_{Str}	Ω	0.99
Rotating field inductance	L_D	mH	9.1
Electrical time constant	T_{el}	ms	9
Mechanical time constant	T_{mech}	ms	1.3
Thermal time constant	T_{th}	min	1.5
Shaft torsional stiffness	C_t	Nm/rad	28700
Weight with brake	m_{MotBr}	kg	12.2
Weight without brake	m_{Mot}	kg	11

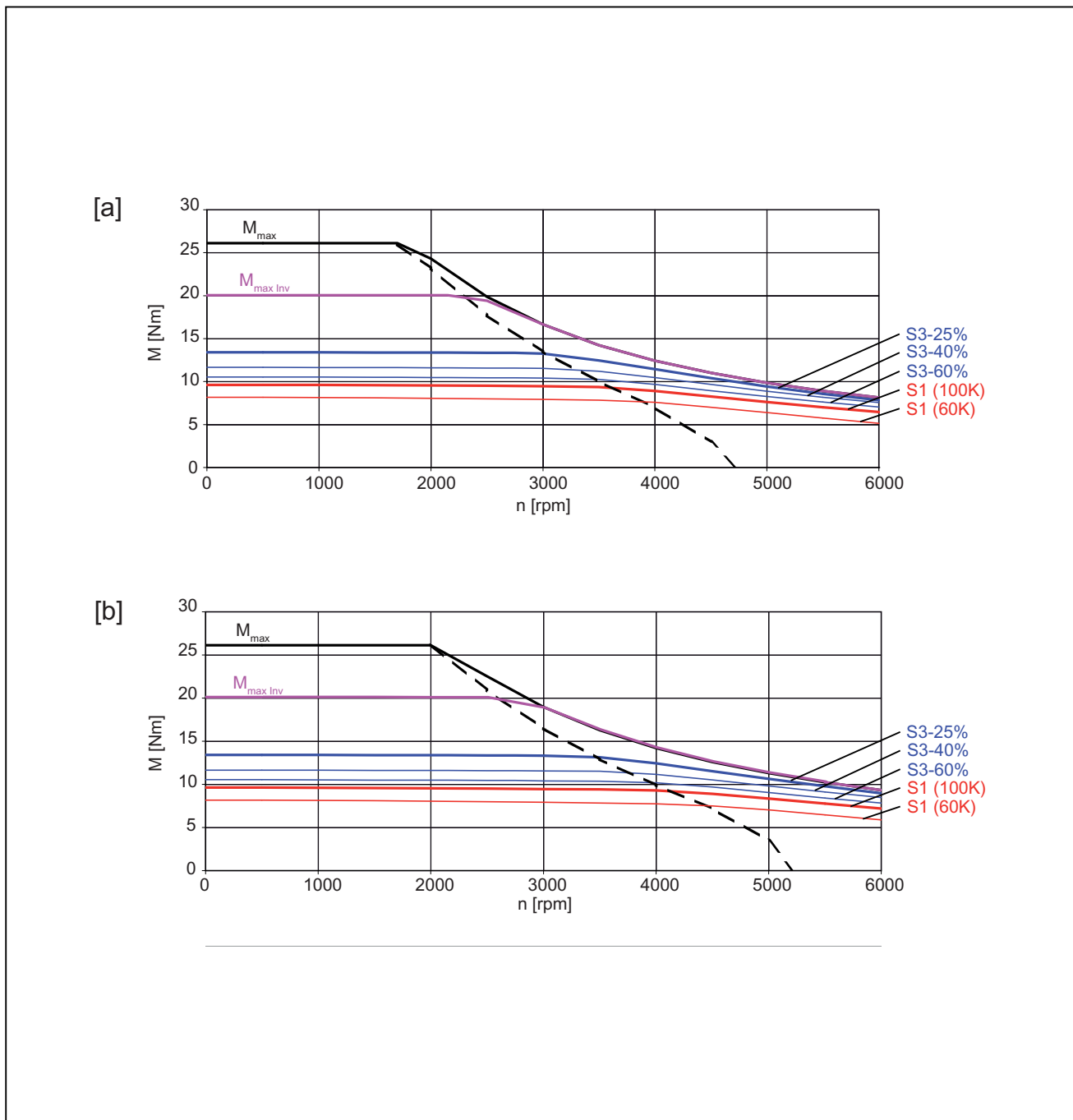

[a] SIMODRIVE 611 (UE), $V_{line} = 400 \text{ V}$, $V_{mot} = 380 \text{ V}_{rms}$

[b] SIMODRIVE 611 (ER), $V_{line} = 400 \text{ V}$, $V_{mot} = 425 \text{ V}_{rms}$

The characteristic curves are only valid for optimized inverter setting data

Figure 4-48 1FT7062-5WF7

4.2 Torque-speed characteristic

Table 4- 45 1FT7062-5WK7

Technical data	Code	Unit	Value
Configuration data			
Rated speed	n_N	rpm	6000
Number of poles	$2p$	---	10
Rated torque (100 K)	$M_N (100 K)$	Nm	9.2
Rated current (100 K)	$I_N (100 K)$	A	12.7
Static torque (60 K)	$M_0 (60 K)$	Nm	8
Static torque (100 K)	$M_0 (100 K)$	Nm	10
Stall current (60 K)	$I_0 (60 K)$	A	10.0
Stall current (100 K)	$I_0 (100 K)$	A	12.5
Moment of inertia (with brake)	J_{MotBr}	10^{-4} kgm^2	10.6
Moment of inertia (without brake)	J_{Mot}	10^{-4} kgm^2	8.1
Optimum operating point			
Optimum speed	n_{opt}	rpm	6000
Optimum power	P_{opt}	kW	5.78
Limiting data			
Max. permissible speed (mech.)	$n_{max mech}$	rpm	9000
Max. permissible speed (inverter)	$n_{max Inv}$	rpm	8000
Maximum torque	M_{max}	Nm	26
Maximum current	I_{max}	A	45.7
Physical constants			
Torque constant	k_T	Nm/A	0.80
Voltage constant	k_E	V/1000 rpm	51
Winding resistance at 20 °C	R_{Str}	Ω	0.35
Rotating field inductance	L_D	mH	3.2
Electrical time constant	T_{el}	ms	9
Mechanical time constant	T_{mech}	ms	1.3
Thermal time constant	T_{th}	min	1.5
Shaft torsional stiffness	C_t	Nm/rad	28700
Weight with brake	m_{MotBr}	kg	12.2
Weight without brake	m_{Mot}	kg	11

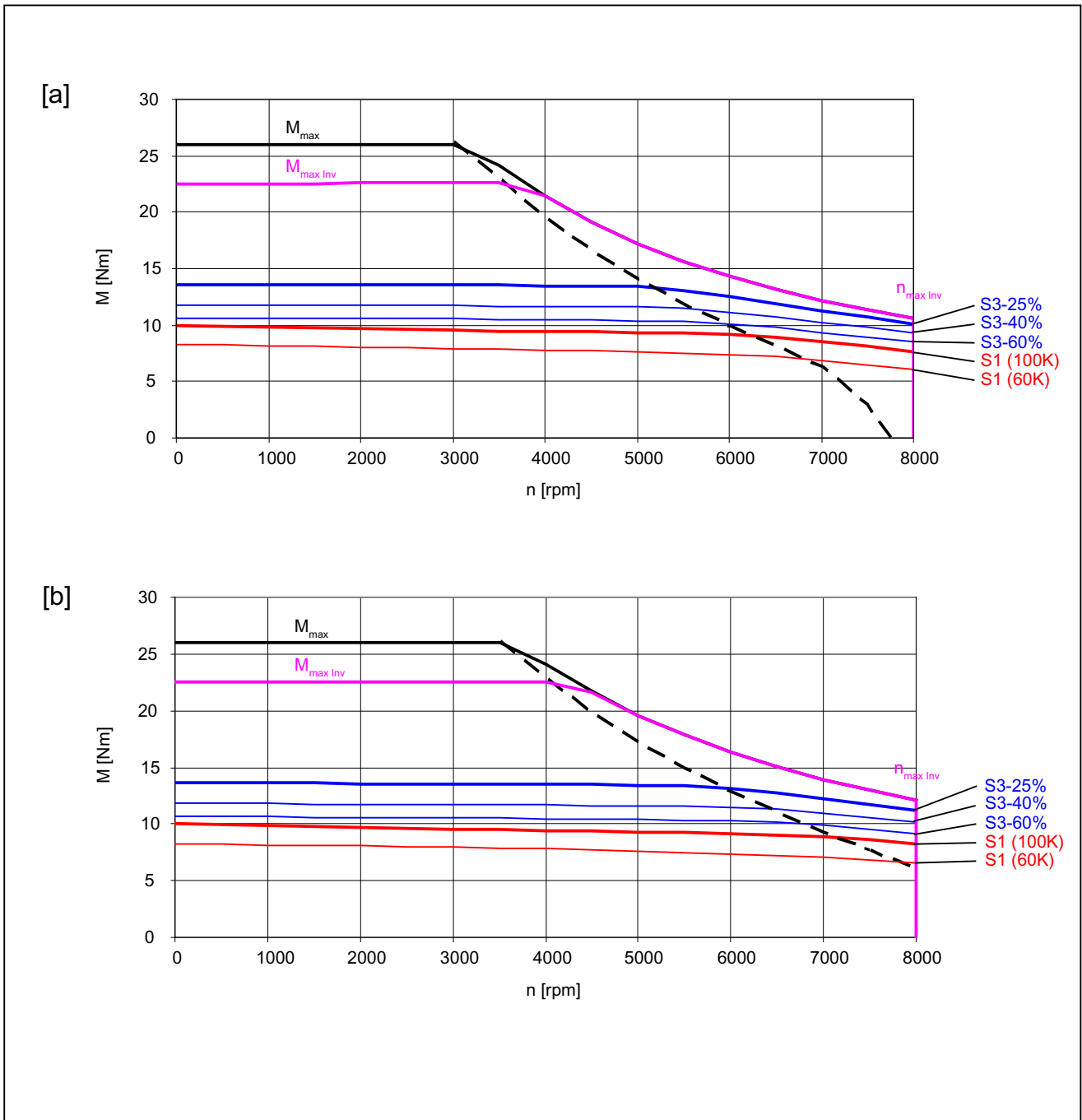

4.2 Torque-speed characteristic

Table 4- 46 1FT7064-5WF7

Technical data	Code	Unit	Value
Configuration data			
Rated speed	n_N	rpm	3000
Number of poles	$2p$	---	10
Rated torque (100 K)	$M_N (100 K)$	Nm	16
Rated current (100 K)	$I_N (100 K)$	A	12.5
Static torque (60 K)	$M_0 (60 K)$	Nm	12.8
Static torque (100 K)	$M_0 (100 K)$	Nm	16
Stall current (60 K)	$I_0 (60 K)$	A	9.5
Stall current (100 K)	$I_0 (100 K)$	A	11.9
Moment of inertia (with brake)	J_{MotBr}	10^{-4} kgm ²	15.4
Moment of inertia (without brake)	J_{Mot}	10^{-4} kgm ²	12.9
Optimum operating point			
Optimum speed	n_{opt}	rpm	3000
Optimum power	P_{opt}	kW	5.03
Limiting data			
Max. permissible speed (mech.)	$n_{max mech}$	rpm	9000
Max. permissible speed (inverter)	$n_{max Inv}$	rpm	6800
Maximum torque	M_{max}	Nm	40
Maximum current	I_{max}	A	39.3
Physical constants			
Torque constant	k_T	Nm/A	1.35
Voltage constant	k_E	V/1000 rpm	85
Winding resistance at 20 °C	R_{Str}	Ω	0.49
Rotating field inductance	L_D	mH	5.3
Electrical time constant	T_{el}	ms	11
Mechanical time constant	T_{mech}	ms	1.0
Thermal time constant	T_{th}	min	1.5
Shaft torsional stiffness	C_t	Nm/rad	26300
Weight with brake	m_{MotBr}	kg	14.8
Weight without brake	m_{Mot}	kg	13.7

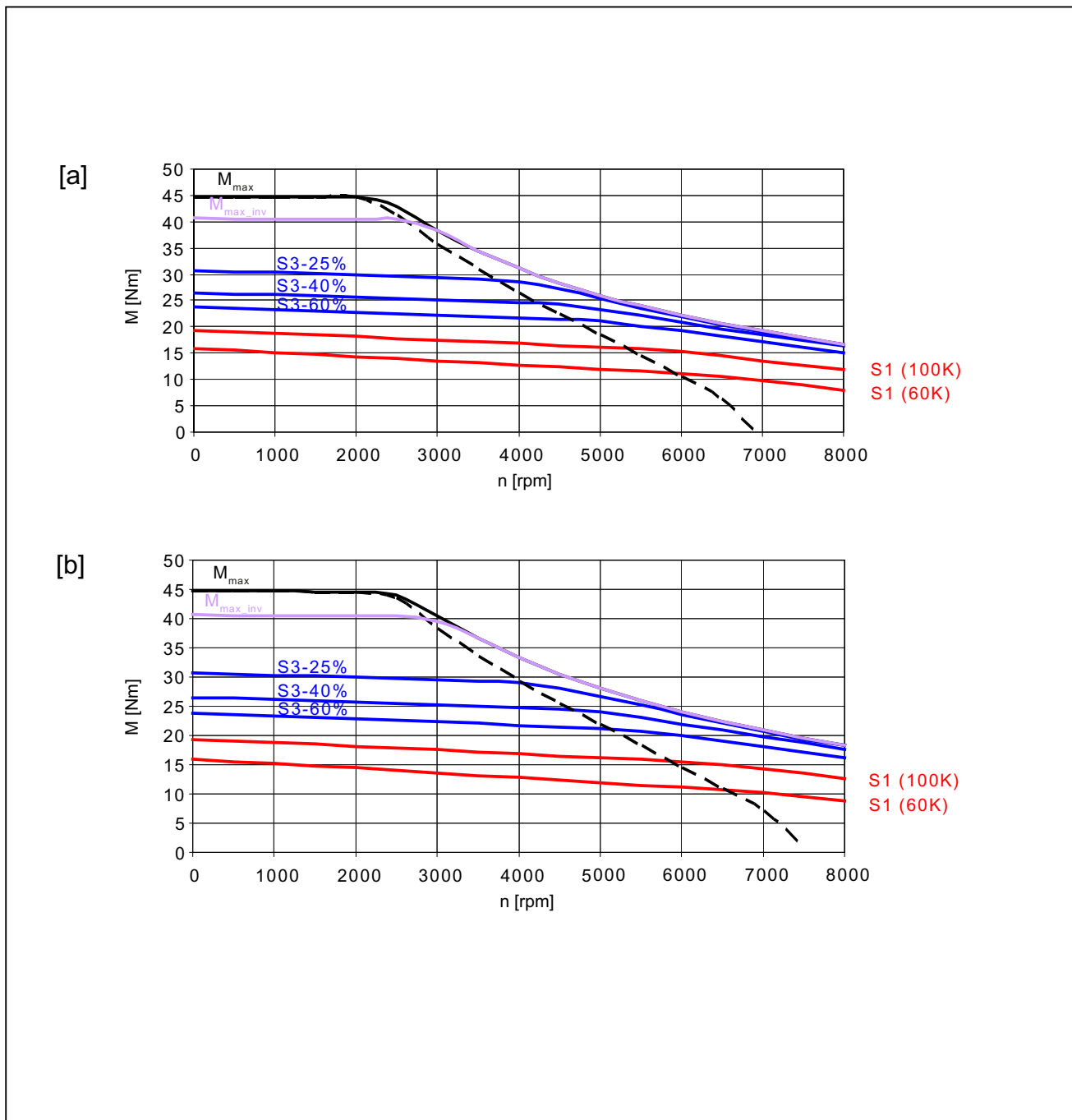

[a] SIMODRIVE 611 (UE), $V_{line} = 400\text{ V}$, $V_{mot} = 380\text{ V}_{rms}$

[b] SIMODRIVE 611 (ER), $V_{line} = 400\text{ V}$, $V_{mot} = 425\text{ V}_{rms}$

The characteristic curves are only valid for optimized inverter setting data

Figure 4-50 1FT7064-5WF7

4.2 Torque-speed characteristic

Table 4- 47 1FT7064-5WK7

Technical data	Code	Unit	Value
Configuration data			
Rated speed	n_N	rpm	6000
Number of poles	$2p$	---	10
Rated torque (100 K)	$M_N (100 K)$	Nm	14.2
Rated current (100 K)	$I_N (100 K)$	A	20.0
Static torque (60 K)	$M_0 (60 K)$	Nm	12.8
Static torque (100 K)	$M_0 (100 K)$	Nm	16
Stall current (60 K)	$I_0 (60 K)$	A	16.1
Stall current (100 K)	$I_0 (100 K)$	A	20.2
Moment of inertia (with brake)	J_{MotBr}	10^{-4} kgm^2	15.4
Moment of inertia (without brake)	J_{Mot}	10^{-4} kgm^2	12.9
Optimum operating point			
Optimum speed	n_{opt}	rpm	6000
Optimum power	P_{opt}	kW	8.92
Limiting data			
Max. permissible speed (mech.)	$n_{max mech}$	rpm	9000
Max. permissible speed (inverter)	$n_{max Inv}$	rpm	8000
Maximum torque	M_{max}	Nm	40
Maximum current	I_{max}	A	67
Physical constants			
Torque constant	k_T	Nm/A	0.79
Voltage constant	k_E	V/1000 rpm	50
Winding resistance at 20 °C	R_{Str}	Ω	0.18
Rotating field inductance	L_D	mH	1.75
Electrical time constant	T_{el}	ms	10
Mechanical time constant	T_{mech}	ms	1.1
Thermal time constant	T_{th}	min	1.5
Shaft torsional stiffness	C_t	Nm/rad	26300
Weight with brake	m_{MotBr}	kg	14.8
Weight without brake	m_{Mot}	kg	13.7

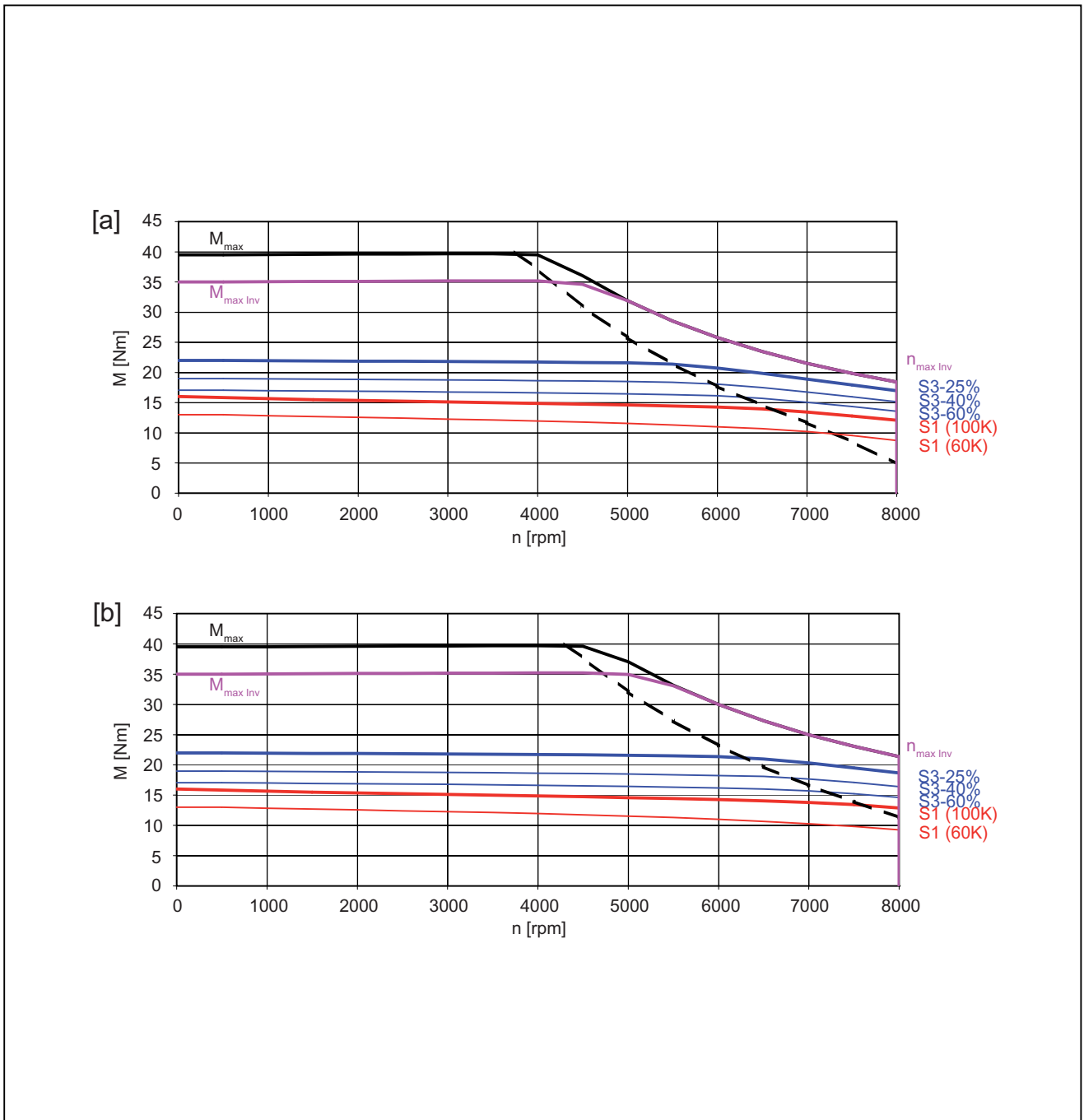

[a] SIMODRIVE 611 (UE), $V_{\text{line}} = 400 \text{ V}$, $V_{\text{mot}} = 380 \text{ V}_{\text{rms}}$

[b] SIMODRIVE 611 (ER), $V_{\text{line}} = 400 \text{ V}$, $V_{\text{mot}} = 425 \text{ V}_{\text{rms}}$

The characteristic curves are only valid for optimized inverter setting data

Figure 4-51 1FT7064-5WK7

4.2 Torque-speed characteristic

Table 4- 48 1FT7066-5WF7

Technical data	Code	Unit	Value
Configuration data			
Rated speed	n_N	rpm	3000
Number of poles	$2p$	---	10
Rated torque (100 K)	$M_N (100 K)$	Nm	19.6
Rated current (100 K)	$I_N (100 K)$	A	14.4
Static torque (60 K)	$M_0 (60 K)$	Nm	16
Static torque (100 K)	$M_0 (100 K)$	Nm	20
Stall current (60 K)	$I_0 (60 K)$	A	11.2
Stall current (100 K)	$I_0 (100 K)$	A	14.0
Moment of inertia (with brake)	J_{MotBr}	10^{-4} kgm ²	20.2
Moment of inertia (without brake)	J_{Mot}	10^{-4} kgm ²	17.7
Optimum operating point			
Optimum speed	n_{opt}	rpm	3000
Optimum power	P_{opt}	kW	6.16
Limiting data			
Max. permissible speed (mech.)	$n_{max mech}$	rpm	9000
Max. permissible speed (inverter)	$n_{max Inv}$	rpm	6400
Maximum torque	M_{max}	Nm	55
Maximum current	I_{max}	A	50
Physical constants			
Torque constant	k_T	Nm/A	1.43
Voltage constant	k_E	V/1000 rpm	90
Winding resistance at 20 °C	R_{Str}	Ω	0.39
Rotating field inductance	L_D	mH	4.07
Electrical time constant	T_{el}	ms	11
Mechanical time constant	T_{mech}	ms	1.0
Thermal time constant	T_{th}	min	1.5
Shaft torsional stiffness	C_t	Nm/rad	24200
Weight with brake	m_{MotBr}	kg	17.4
Weight without brake	m_{Mot}	kg	16.3

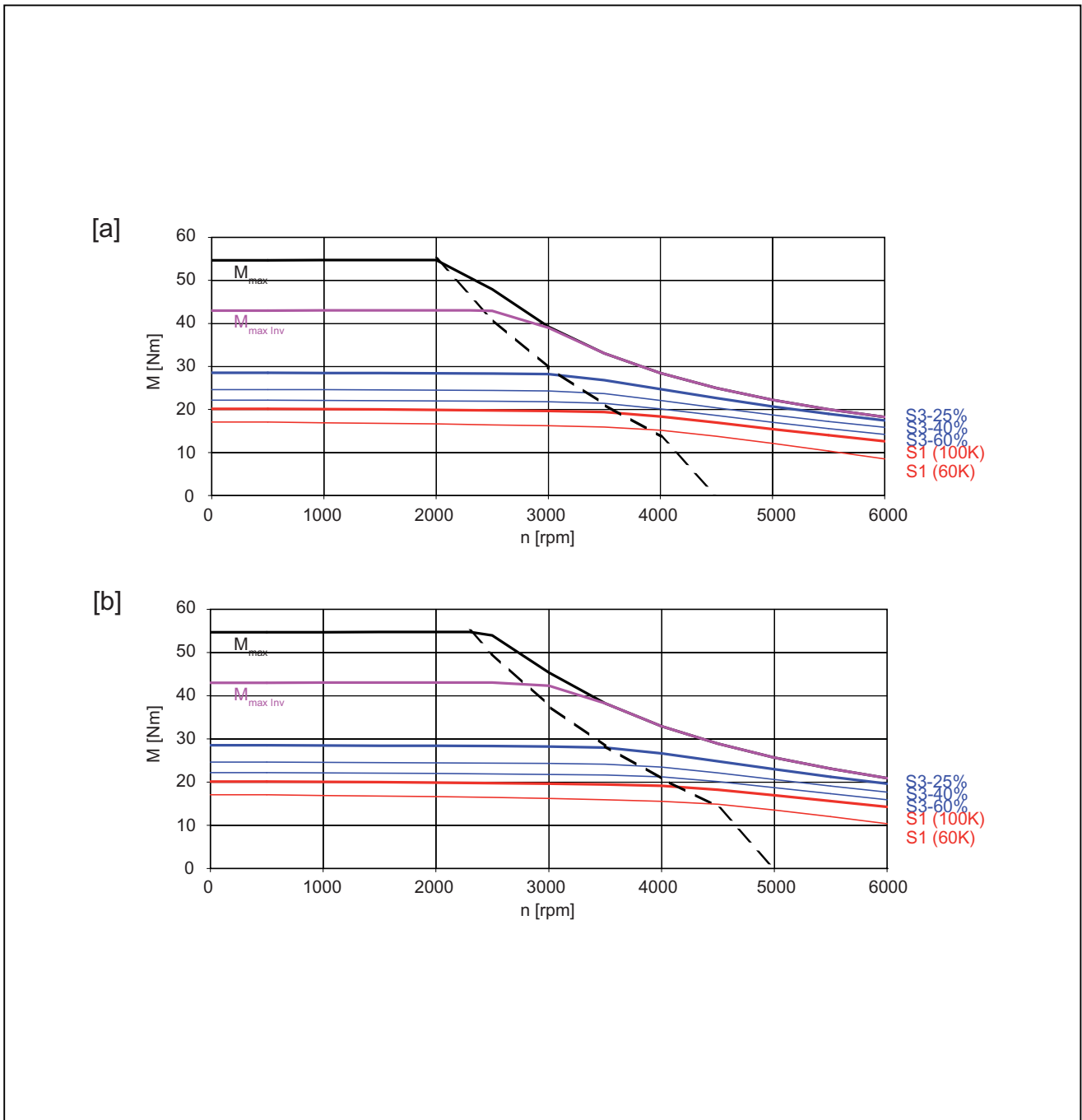

[a] SIMODRIVE 611 (UE), $V_{\text{line}} = 400$ V, $V_{\text{mot}} = 380$ V_{rms}

[b] SIMODRIVE 611 (ER), $V_{\text{line}} = 400$ V, $V_{\text{mot}} = 425$ V_{rms}

The characteristic curves are only valid for optimized inverter setting data

Figure 4-52 1FT7066-5WF7

4.2 Torque-speed characteristic

Table 4- 49 1FT7066-5WH7

Technical data	Code	Unit	Value
Configuration data			
Rated speed	n_N	rpm	4500
Number of poles	$2p$	---	10
Rated torque (100 K)	$M_N (100 K)$	Nm	19.4
Rated current (100 K)	$I_N (100 K)$	A	20.8
Static torque (60 K)	$M_0 (60 K)$	Nm	16
Static torque (100 K)	$M_0 (100 K)$	Nm	20
Stall current (60 K)	$I_0 (60 K)$	A	15.7
Stall current (100 K)	$I_0 (100 K)$	A	19.7
Moment of inertia (with brake)	J_{MotBr}	10^{-4} kgm ²	20.2
Moment of inertia (without brake)	J_{Mot}	10^{-4} kgm ²	17.7
Optimum operating point			
Optimum speed	n_{opt}	rpm	4500
Optimum power	P_{opt}	kW	9.14
Limiting data			
Max. permissible speed (mech.)	$n_{max mech}$	rpm	9000
Max. permissible speed (inverter)	$n_{max Inv}$	rpm	8000
Maximum torque	M_{max}	Nm	55
Maximum current	I_{max}	A	70.5
Physical constants			
Torque constant	k_T	Nm/A	1.02
Voltage constant	k_E	V/1000 rpm	64
Winding resistance at 20 °C	R_{Str}	Ω	0.19
Rotating field inductance	L_D	mH	2.05
Electrical time constant	T_{el}	ms	11
Mechanical time constant	T_{mech}	ms	1.0
Thermal time constant	T_{th}	min	1.5
Shaft torsional stiffness	C_t	Nm/rad	24200
Weight with brake	m_{MotBr}	kg	17.4
Weight without brake	m_{Mot}	kg	16.3

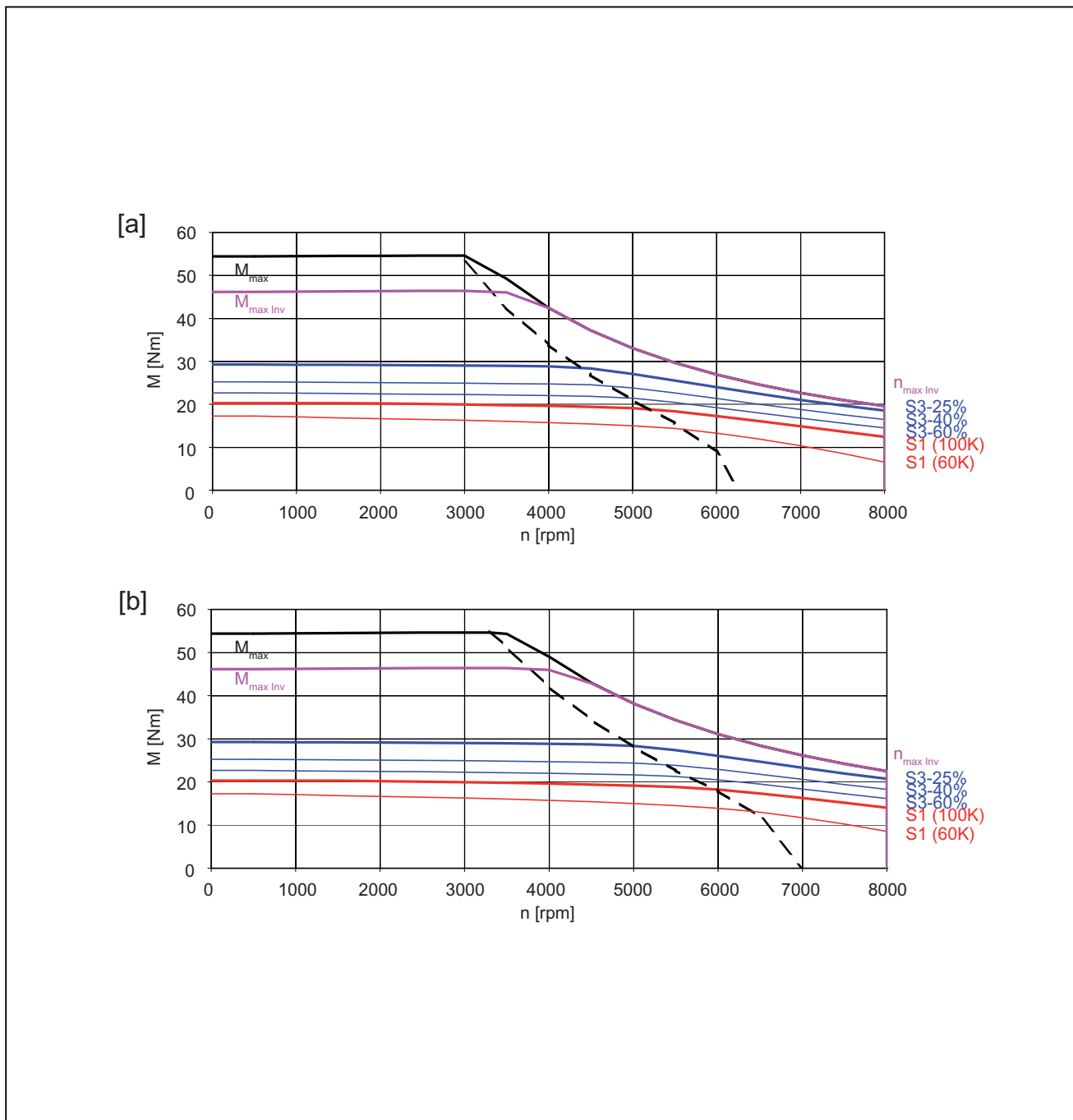

[a] SIMODRIVE 611 (UE), $V_{\text{line}} = 400 V$, $V_{\text{mot}} = 380 V_{\text{rms}}$

[b] SIMODRIVE 611 (ER), $V_{\text{line}} = 400 V$, $V_{\text{mot}} = 425 V_{\text{rms}}$

The characteristic curves are only valid for optimized inverter setting data

Figure 4-53 1FT7066-5WH7

4.2 Torque-speed characteristic

Table 4- 50 1FT7068-5WF7

Technical data	Code	Unit	Value
Configuration data			
Rated speed	n_N	rpm	3000
Number of poles	$2p$	---	10
Rated torque (100 K)	$M_N (100 K)$	Nm	29.5
Rated current (100 K)	$I_N (100 K)$	A	19.6
Static torque (60 K)	$M_0 (60 K)$	Nm	24
Static torque (100 K)	$M_0 (100 K)$	Nm	30
Stall current (60 K)	$I_0 (60 K)$	A	15.2
Stall current (100 K)	$I_0 (100 K)$	A	19.0
Moment of inertia (with brake)	J_{MotBr}	10^{-4} kgm ²	27.4
Moment of inertia (without brake)	J_{Mot}	10^{-4} kgm ²	24.8
Optimum operating point			
Optimum speed	n_{opt}	rpm	3000
Optimum power	P_{opt}	kW	9.27
Limiting data			
Max. permissible speed (mech.)	$n_{max mech}$	rpm	9000
Max. permissible speed (inverter)	$n_{max Inv}$	rpm	5800
Maximum torque	M_{max}	Nm	70
Maximum current	I_{max}	A	55.5
Physical constants			
Torque constant	k_T	Nm/A	1.58
Voltage constant	k_E	V/1000 rpm	99.5
Winding resistance at 20 °C	R_{Str}	Ω	0.31
Rotating field inductance	L_D	mH	3.35
Electrical time constant	T_{el}	ms	11
Mechanical time constant	T_{mech}	ms	0.9
Thermal time constant	T_{th}	min	1.5
Shaft torsional stiffness	C_t	Nm/rad	21700
Weight with brake	m_{MotBr}	kg	21.3
Weight without brake	m_{Mot}	kg	20.1

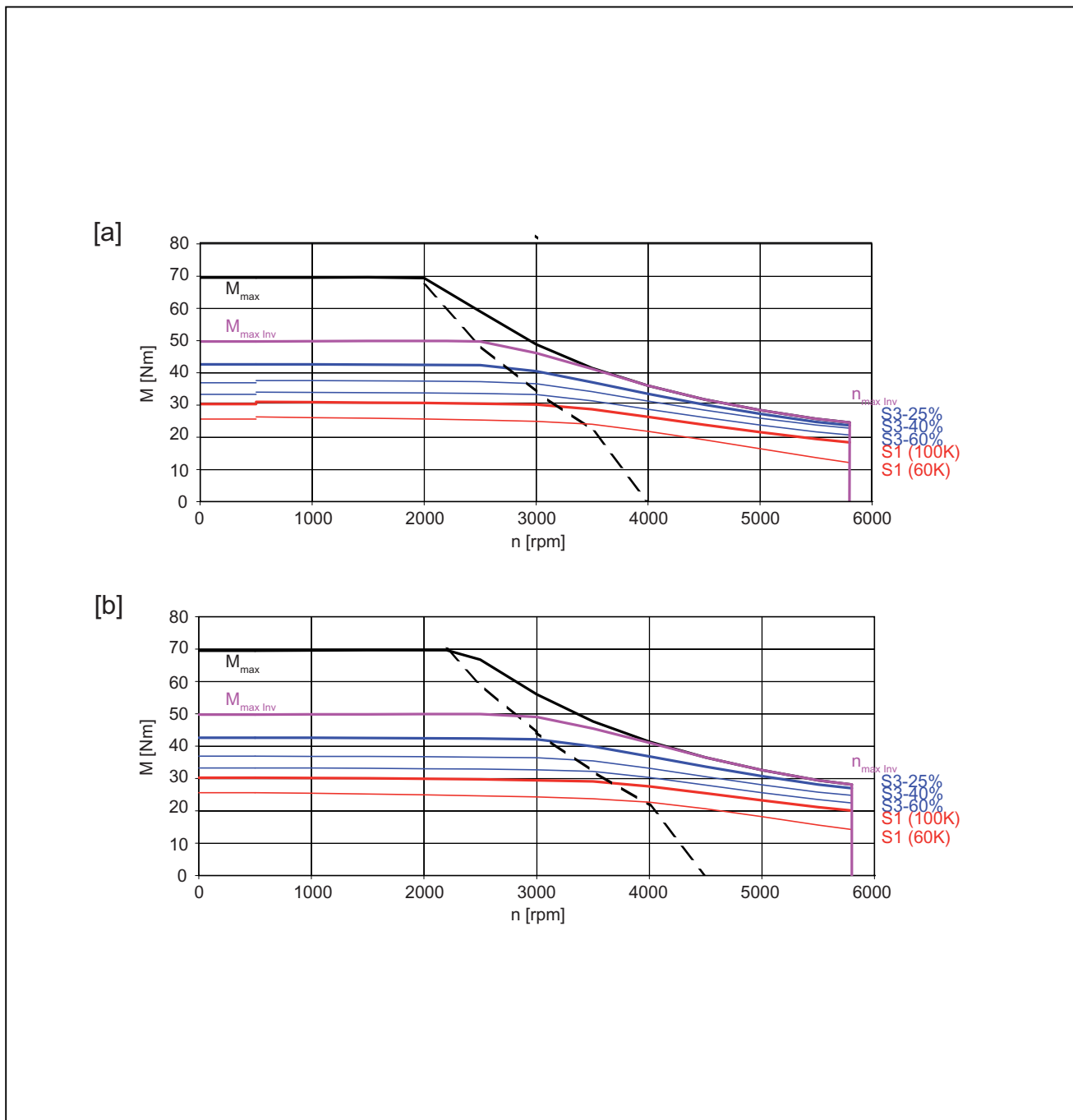

[a] SIMODRIVE 611 (UE), $V_{line} = 400\text{ V}$, $V_{mot} = 380\text{ V}_{rms}$

[b] SIMODRIVE 611 (ER), $V_{line} = 400\text{ V}$, $V_{mot} = 425\text{ V}_{rms}$

The characteristic curves are only valid for optimized inverter setting data

Figure 4-54 1FT7068-5WF7

4.2 Torque-speed characteristic

Table 4- 51 1FT7082-5WC7

Technical data	Code	Unit	Value
Configuration data			
Rated speed	n_N	rpm	2000
Number of poles	$2p$	---	10
Rated torque (100 K)	$M_N (100 K)$	Nm	21
Rated current (100 K)	$I_N (100 K)$	A	11
Static torque (60 K)	$M_0 (60 K)$	Nm	17.5
Static torque (100 K)	$M_0 (100 K)$	Nm	21
Stall current (60 K)	$I_0 (60 K)$	A	8.9
Stall current (100 K)	$I_0 (100 K)$	A	10.7
Moment of inertia (with brake)	J_{MotBr}	10^{-4} kgm^2	43.0
Moment of inertia (without brake)	J_{Mot}	10^{-4} kgm^2	28.9
Optimum operating point			
Optimum speed	n_{opt}	rpm	2000
Optimum power	P_{opt}	kW	4.40
Limiting data			
Max. permissible speed (mech.)	$n_{max mech}$	rpm	8000
Max. permissible speed (inverter)	$n_{max Inv}$	rpm	4700
Maximum torque	M_{max}	Nm	55
Maximum current	I_{max}	A	36.3
Physical constants			
Torque constant	k_T	Nm/A	1.96
Voltage constant	k_E	V/1000 rpm	123
Winding resistance at 20 °C	R_{Str}	Ω	0.611
Rotating field inductance	L_D	mH	9.15
Electrical time constant	T_{el}	ms	15
Mechanical time constant	T_{mech}	ms	1.4
Thermal time constant	T_{th}	min	1.5
Shaft torsional stiffness	C_t	Nm/rad	75800
Weight with brake	m_{MotBr}	kg	23.7
Weight without brake	m_{Mot}	kg	20.7

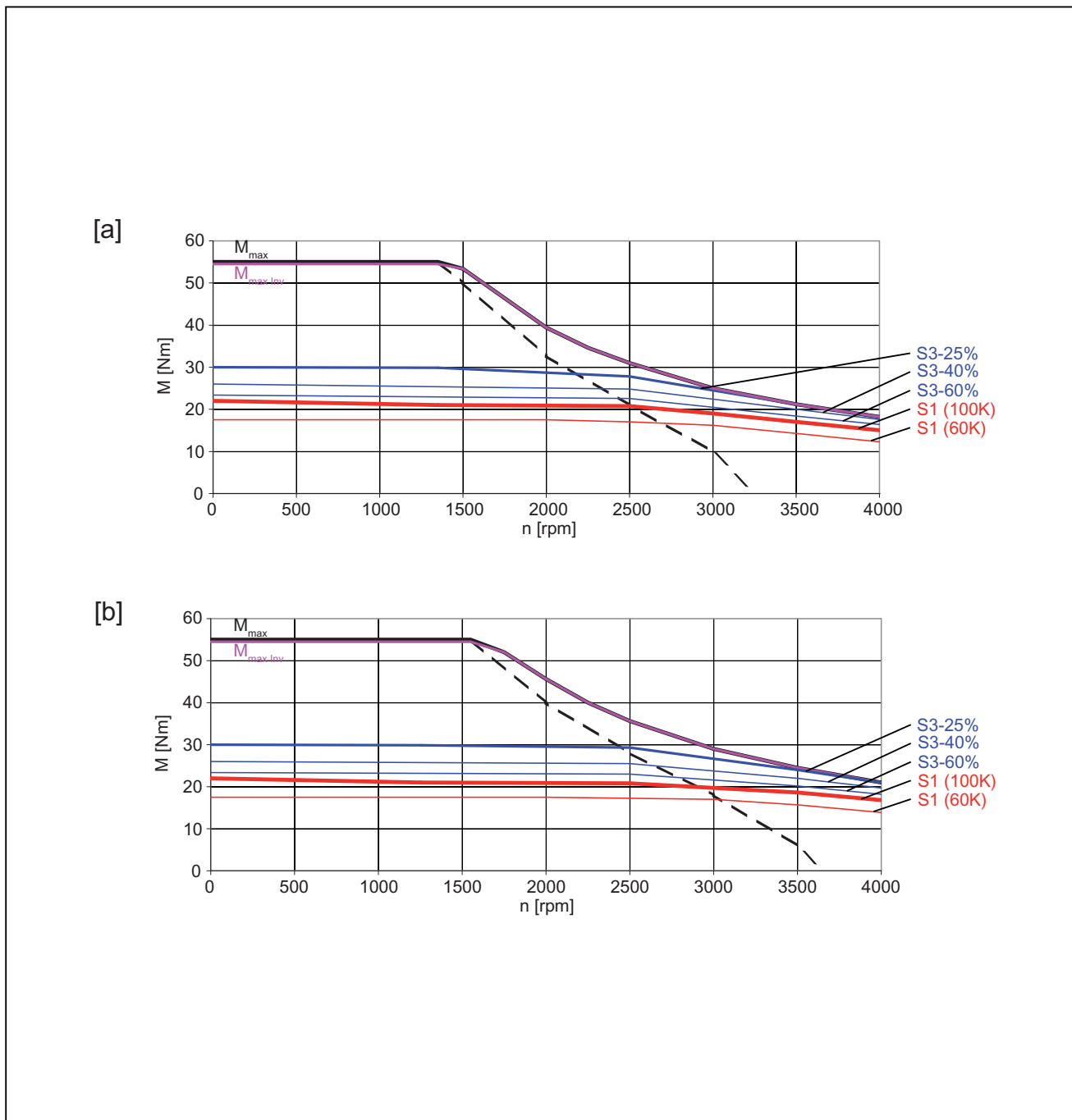

[a] SIMODRIVE 611 (UE), $V_{line} = 400 \text{ V}$, $V_{mot} = 380 \text{ V}_{rms}$

[b] SIMODRIVE 611 (ER), $V_{line} = 400 \text{ V}$, $V_{mot} = 425 \text{ V}_{rms}$

The characteristic curves are only valid for optimized inverter setting data

Figure 4-55 1FT7082-5WC7

4.2 Torque-speed characteristic

Table 4- 52 1FT7082-5WF7

Technical data	Code	Unit	Value
Configuration data			
Rated speed	n_N	rpm	3000
Number of poles	$2p$	---	10
Rated torque (100 K)	$M_N (100 K)$	Nm	20.5
Rated current (100 K)	$I_N (100 K)$	A	16
Static torque (60 K)	$M_0 (60 K)$	Nm	17.5
Static torque (100 K)	$M_0 (100 K)$	Nm	21
Stall current (60 K)	$I_0 (60 K)$	A	13.3
Stall current (100 K)	$I_0 (100 K)$	A	16.0
Moment of inertia (with brake)	J_{MotBr}	10^{-4} kgm ²	43.0
Moment of inertia (without brake)	J_{Mot}	10^{-4} kgm ²	28.9
Optimum operating point			
Optimum speed	n_{opt}	rpm	3000
Optimum power	P_{opt}	kW	6.44
Limiting data			
Max. permissible speed (mech.)	$n_{max mech}$	rpm	8000
Max. permissible speed (inverter)	$n_{max Inv}$	rpm	7000
Maximum torque	M_{max}	Nm	55
Maximum current	I_{max}	A	54
Physical constants			
Torque constant	k_T	Nm/A	1.31
Voltage constant	k_E	V/1000 rpm	83
Winding resistance at 20 °C	R_{Str}	Ω	0.285
Rotating field inductance	L_D	mH	4.15
Electrical time constant	T_{el}	ms	15
Mechanical time constant	T_{mech}	ms	1.4
Thermal time constant	T_{th}	min	1.5
Shaft torsional stiffness	C_t	Nm/rad	75800
Weight with brake	m_{MotBr}	kg	23.7
Weight without brake	m_{Mot}	kg	20.7

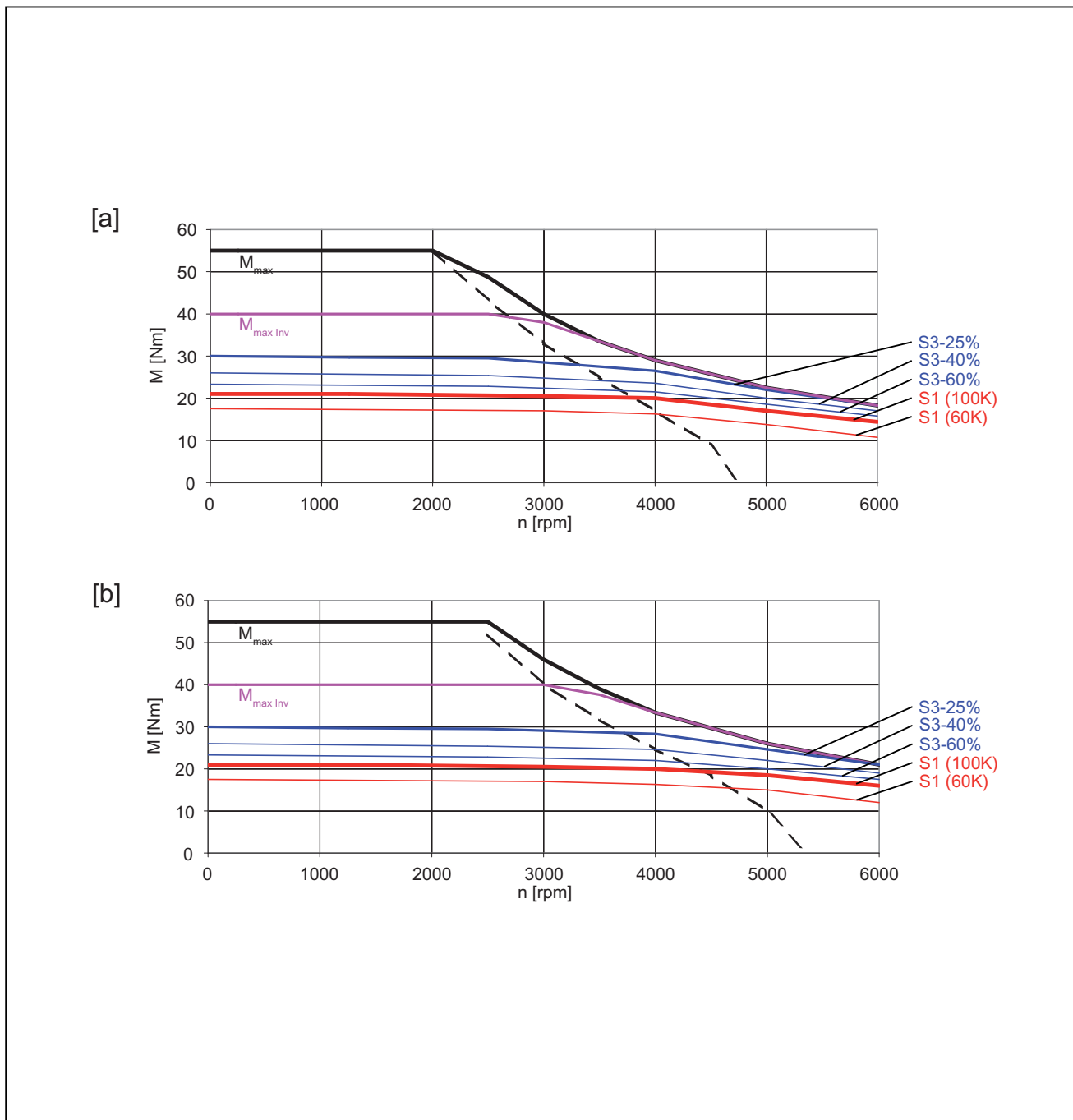

[a] SIMODRIVE 611 (UE), $V_{\text{line}} = 400$ V, $V_{\text{mot}} = 380$ V_{rms}

[b] SIMODRIVE 611 (ER), $V_{\text{line}} = 400$ V, $V_{\text{mot}} = 425$ V_{rms}

The characteristic curves are only valid for optimized inverter setting data

Figure 4-56 1FT7082-5WF7

4.2 Torque-speed characteristic

Table 4- 53 1FT7082-5WH7

Technical data	Code	Unit	Value
Configuration data			
Rated speed	n_N	rpm	4500
Number of poles	$2p$	---	10
Rated torque (100 K)	$M_N (100 K)$	Nm	19
Rated current (100 K)	$I_N (100 K)$	A	23.9
Static torque (60 K)	$M_0 (60 K)$	Nm	17.5
Static torque (100 K)	$M_0 (100 K)$	Nm	21
Stall current (60 K)	$I_0 (60 K)$	A	20.0
Stall current (100 K)	$I_0 (100 K)$	A	24.0
Moment of inertia (with brake)	J_{MotBr}	10^{-4} kgm^2	43.0
Moment of inertia (without brake)	J_{Mot}	10^{-4} kgm^2	28.9
Optimum operating point			
Optimum speed	n_{opt}	rpm	4500
Optimum power	P_{opt}	kW	8.95
Limiting data			
Max. permissible speed (mech.)	$n_{max mech}$	rpm	8000
Max. permissible speed (inverter)	$n_{max Inv}$	rpm	8000
Maximum torque	M_{max}	Nm	55
Maximum current	I_{max}	A	82
Physical constants			
Torque constant	k_T	Nm/A	0.87
Voltage constant	k_E	V/1000 rpm	54.5
Winding resistance at 20 °C	R_{Str}	Ω	0.122
Rotating field inductance	L_D	mH	1.79
Electrical time constant	T_{el}	ms	15
Mechanical time constant	T_{mech}	ms	1.4
Thermal time constant	T_{th}	min	1.5
Shaft torsional stiffness	C_t	Nm/rad	75800
Weight with brake	m_{MotBr}	kg	23.7
Weight without brake	m_{Mot}	kg	20.7

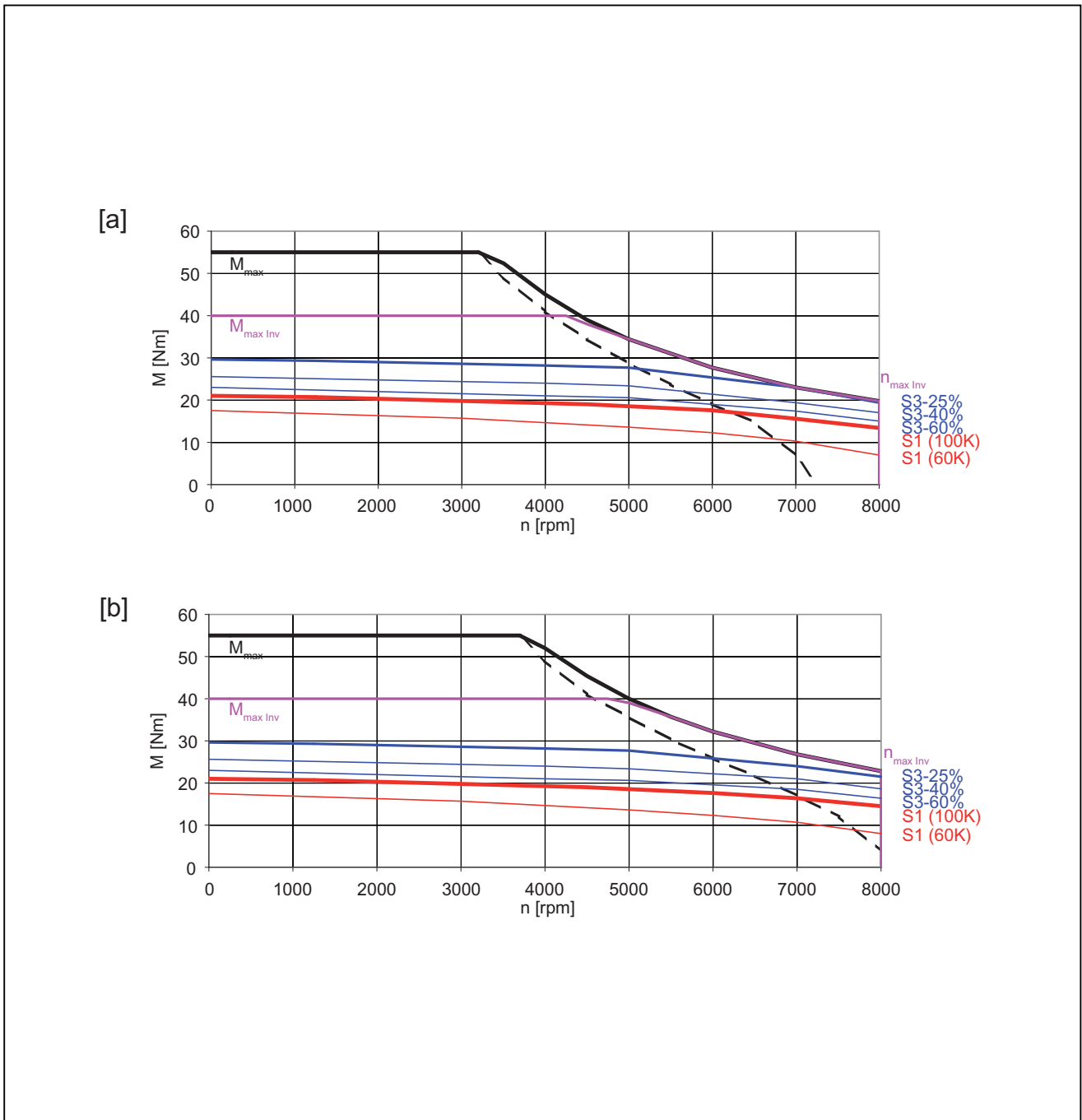

[a] SIMODRIVE 611 (UE), $V_{line} = 400 V$, $V_{mot} = 380 V_{rms}$

[b] SIMODRIVE 611 (ER), $V_{line} = 400 V$, $V_{mot} = 425 V_{rms}$

The characteristic curves are only valid for optimized inverter setting data

Figure 4-57 1FT7082-5WH7

4.2 Torque-speed characteristic

Table 4- 54 1FT7084-5WC7

Technical data	Code	Unit	Value
Configuration data			
Rated speed	n_N	rpm	2000
Number of poles	$2p$	---	10
Rated torque (100 K)	$M_N (100 K)$	Nm	35
Rated current (100 K)	$I_N (100 K)$	A	17
Static torque (60 K)	$M_0 (60 K)$	Nm	29.0
Static torque (100 K)	$M_0 (100 K)$	Nm	35
Stall current (60 K)	$I_0 (60 K)$	A	13.7
Stall current (100 K)	$I_0 (100 K)$	A	16.5
Moment of inertia (with brake)	J_{MotBr}	10^{-4} kgm^2	62.5
Moment of inertia (without brake)	J_{Mot}	10^{-4} kgm^2	48.3
Optimum operating point			
Optimum speed	n_{opt}	rpm	2000
Optimum power	P_{opt}	kW	7.33
Limiting data			
Max. permissible speed (mech.)	$n_{max \text{ mech}}$	rpm	8000
Max. permissible speed (inverter)	$n_{max \text{ Inv}}$	rpm	4400
Maximum torque	M_{max}	Nm	90
Maximum current	I_{max}	A	56
Physical constants			
Torque constant	k_T	Nm/A	2.12
Voltage constant	k_E	V/1000 rpm	133
Winding resistance at 20 °C	R_{Str}	Ω	0.345
Rotating field inductance	L_D	mH	5.9
Electrical time constant	T_{el}	ms	17
Mechanical time constant	T_{mech}	ms	1.1
Thermal time constant	T_{th}	min	1.5
Shaft torsional stiffness	C_t	Nm/rad	65200
Weight with brake	m_{MotBr}	kg	30.5
Weight without brake	m_{Mot}	kg	27.5

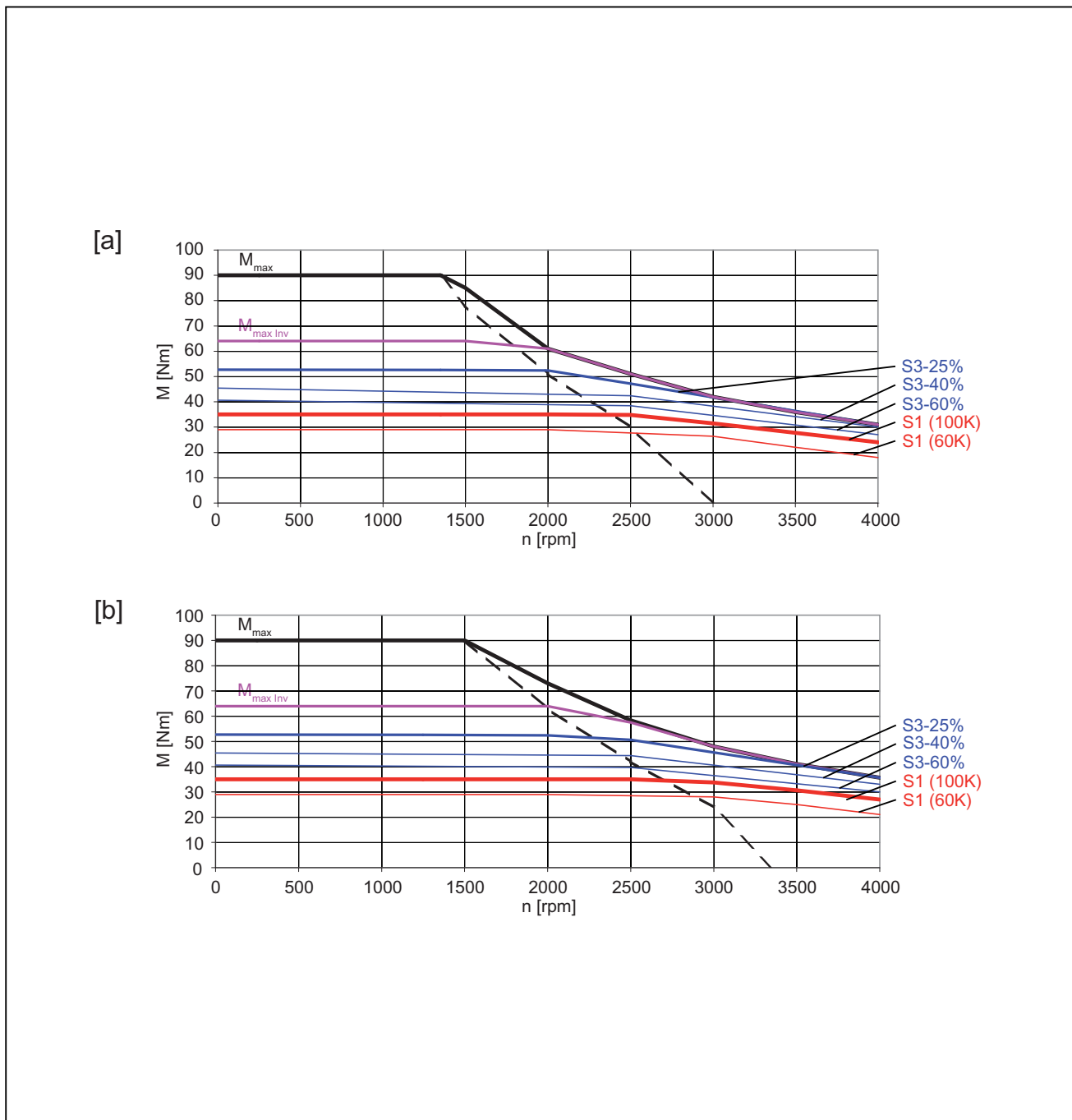

[a] SIMODRIVE 611 (UE), $V_{line} = 400 \text{ V}$, $V_{mot} = 380 \text{ V}_{rms}$

[b] SIMODRIVE 611 (ER), $V_{line} = 400 \text{ V}$, $V_{mot} = 425 \text{ V}_{rms}$

The characteristic curves are only valid for optimized inverter setting data

Figure 4-58 1FT7084-5WC7

4.2 Torque-speed characteristic

Table 4- 55 1FT7084-5WF7

Technical data	Code	Unit	Value
Configuration data			
Rated speed	n_N	rpm	3000
Number of poles	$2p$	---	10
Rated torque (100 K)	$M_N (100 K)$	Nm	35
Rated current (100 K)	$I_N (100 K)$	A	24.2
Static torque (60 K)	$M_0 (60 K)$	Nm	29.0
Static torque (100 K)	$M_0 (100 K)$	Nm	35
Stall current (60 K)	$I_0 (60 K)$	A	19.1
Stall current (100 K)	$I_0 (100 K)$	A	23.0
Moment of inertia (with brake)	J_{MotBr}	10^{-4} kgm^2	62.5
Moment of inertia (without brake)	J_{Mot}	10^{-4} kgm^2	48.3
Optimum operating point			
Optimum speed	n_{opt}	rpm	3000
Optimum power	P_{opt}	kW	11.0
Limiting data			
Max. permissible speed (mech.)	$n_{max mech}$	rpm	8000
Max. permissible speed (inverter)	$n_{max Inv}$	rpm	6100
Maximum torque	M_{max}	Nm	90
Maximum current	I_{max}	A	78
Physical constants			
Torque constant	k_T	Nm/A	1.52
Voltage constant	k_E	V/1000 rpm	95
Winding resistance at 20 °C	R_{Str}	Ω	0.182
Rotating field inductance	L_D	mH	3.1
Electrical time constant	T_{el}	ms	17
Mechanical time constant	T_{mech}	ms	1.1
Thermal time constant	T_{th}	min	1.5
Shaft torsional stiffness	C_t	Nm/rad	65200
Weight with brake	m_{MotBr}	kg	30.5
Weight without brake	m_{Mot}	kg	27.5

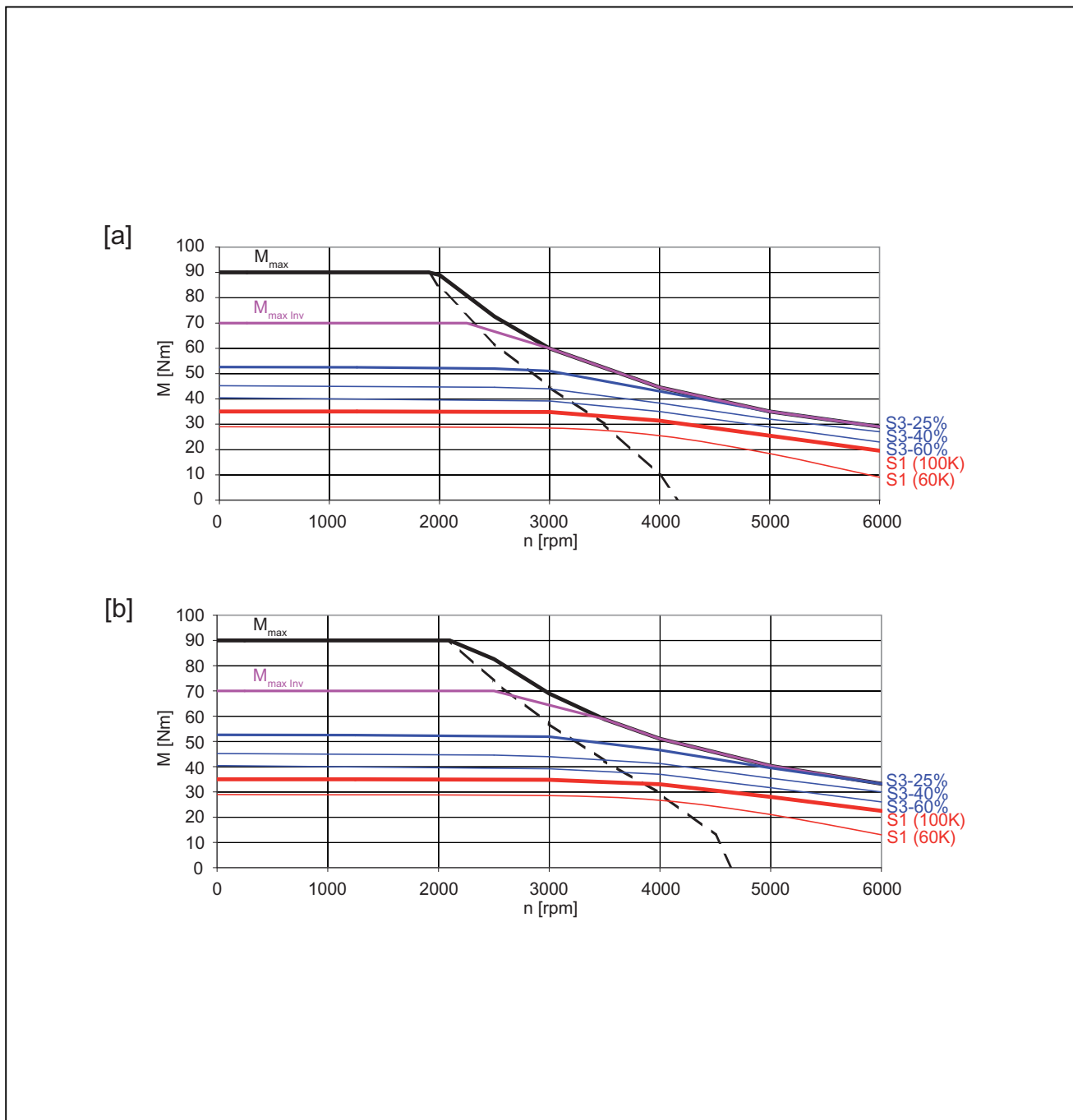

[a] SIMODRIVE 611 (UE), $V_{line} = 400 V$, $V_{mot} = 380 V_{rms}$

[b] SIMODRIVE 611 (ER), $V_{line} = 400 V$, $V_{mot} = 425 V_{rms}$

The characteristic curves are only valid for optimized inverter setting data

Figure 4-59 1FT7084-5WF7

4.2 Torque-speed characteristic

Table 4- 56 1FT7084-5WH7

Technical data	Code	Unit	Value
Configuration data			
Rated speed	n_N	rpm	4500
Number of poles	$2p$	---	10
Rated torque (100 K)	$M_N (100 K)$	Nm	32
Rated current (100 K)	$I_N (100 K)$	A	34.5
Static torque (60 K)	$M_0 (60 K)$	Nm	29.0
Static torque (100 K)	$M_0 (100 K)$	Nm	35
Stall current (60 K)	$I_0 (60 K)$	A	28.4
Stall current (100 K)	$I_0 (100 K)$	A	34.3
Moment of inertia (with brake)	J_{MotBr}	10^{-4} kgm ²	62.5
Moment of inertia (without brake)	J_{Mot}	10^{-4} kgm ²	48.3
Optimum operating point			
Optimum speed	n_{opt}	rpm	4500
Optimum power	P_{opt}	kW	15.1
Limiting data			
Max. permissible speed (mech.)	$n_{max mech}$	rpm	8000
Max. permissible speed (inverter)	$n_{max Inv}$	rpm	8000
Maximum torque	M_{max}	Nm	90
Maximum current	I_{max}	A	116
Physical constants			
Torque constant	k_T	Nm/A	1.02
Voltage constant	k_E	V/1000 rpm	64
Winding resistance at 20 °C	R_{Str}	Ω	0.085
Rotating field inductance	L_D	mH	1.4
Electrical time constant	T_{el}	ms	16
Mechanical time constant	T_{mech}	ms	1.2
Thermal time constant	T_{th}	min	1.5
Shaft torsional stiffness	C_t	Nm/rad	65200
Weight with brake	m_{MotBr}	kg	30.5
Weight without brake	m_{Mot}	kg	27.5

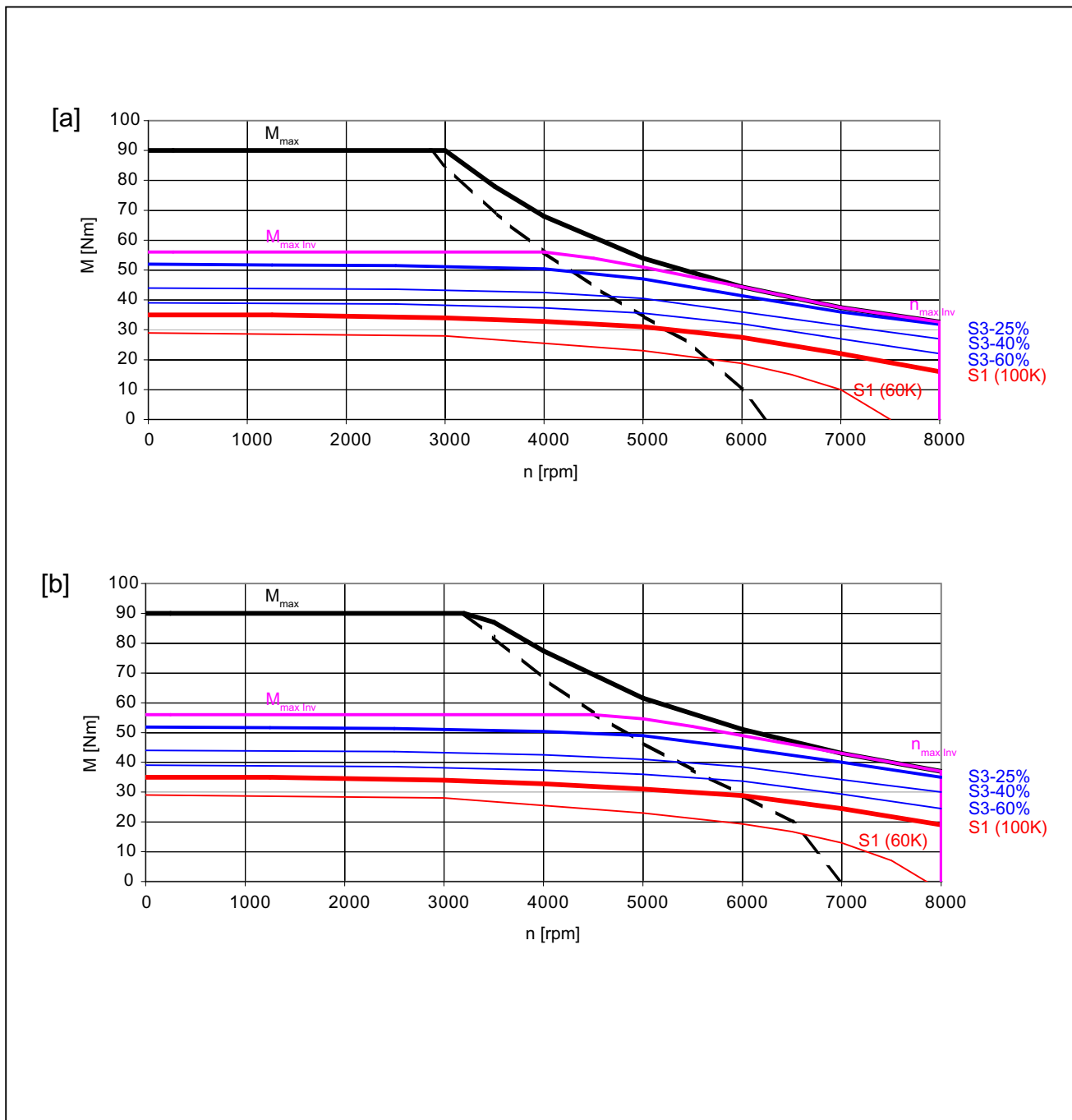

[a] SIMODRIVE 611 (UE), $V_{line} = 400$ V, $V_{mot} = 380$ V_{rms}

[b] SIMODRIVE 611 (ER), $V_{line} = 400$ V, $V_{mot} = 425$ V_{rms}

The characteristic curves are only valid for optimized inverter setting data

Figure 4-60 1FT7084-5WH7

4.2 Torque-speed characteristic

Table 4- 57 1FT7086-5WC7

Technical data	Code	Unit	Value
Configuration data			
Rated speed	n_N	rpm	2000
Number of poles	$2p$	---	10
Rated torque (100 K)	$M_N (100 K)$	Nm	50
Rated current (100 K)	$I_N (100 K)$	A	24
Static torque (60 K)	$M_0 (60 K)$	Nm	41
Static torque (100 K)	$M_0 (100 K)$	Nm	50
Stall current (60 K)	$I_0 (60 K)$	A	19.0
Stall current (100 K)	$I_0 (100 K)$	A	23.0
Moment of inertia (with brake)	J_{MotBr}	10^{-4} kgm^2	81.9
Moment of inertia (without brake)	J_{Mot}	10^{-4} kgm^2	67.8
Optimum operating point			
Optimum speed	n_{opt}	rpm	2000
Optimum power	P_{opt}	kW	10.5
Limiting data			
Max. permissible speed (mech.)	$n_{max mech}$	rpm	8000
Max. permissible speed (inverter)	$n_{max Inv}$	rpm	4300
Maximum torque	M_{max}	Nm	125
Maximum current	I_{max}	A	75
Physical constants			
Torque constant	k_T	Nm/A	2.17
Voltage constant	k_E	V/1000 rpm	136
Winding resistance at 20 °C	R_{Str}	Ω	0.245
Rotating field inductance	L_D	mH	4.8
Electrical time constant	T_{el}	ms	20
Mechanical time constant	T_{mech}	ms	1.1
Thermal time constant	T_{th}	min	1.5
Shaft torsional stiffness	C_t	Nm/rad	57100
Weight with brake	m_{MotBr}	kg	37.1
Weight without brake	m_{Mot}	kg	34.1

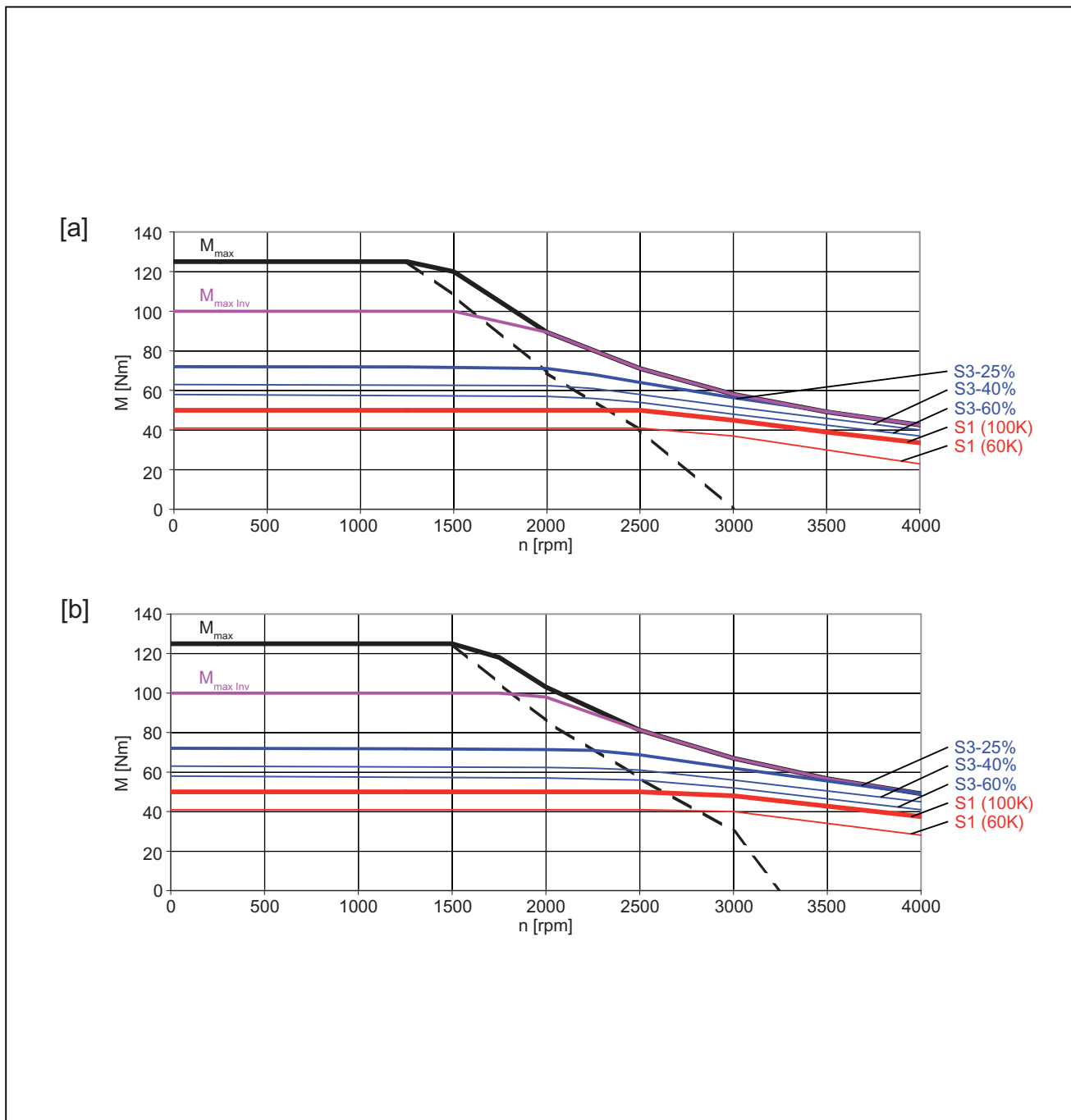

[a] SIMODRIVE 611 (UE), $V_{line} = 400 \text{ V}$, $V_{mot} = 380 \text{ V}_{rms}$

[b] SIMODRIVE 611 (UE), $V_{line} = 400 \text{ V}$, $V_{mot} = 380 \text{ V}_{rms}$

The characteristic curves are only valid for optimized inverter setting data

Figure 4-61 1FT7086-5WC7

4.2 Torque-speed characteristic

Table 4- 58 1FT7086-5WF7

Technical data	Code	Unit	Value
Configuration data			
Rated speed	n_N	rpm	3000
Number of poles	$2p$	---	10
Rated torque (100 K)	$M_N (100 K)$	Nm	49
Rated current (100 K)	$I_N (100 K)$	A	36
Static torque (60 K)	$M_0 (60 K)$	Nm	41
Static torque (100 K)	$M_0 (100 K)$	Nm	50
Stall current (60 K)	$I_0 (60 K)$	A	27.9
Stall current (100 K)	$I_0 (100 K)$	A	34.0
Moment of inertia (with brake)	J_{MotBr}	10^{-4} kgm ²	81.9
Moment of inertia (without brake)	J_{Mot}	10^{-4} kgm ²	67.8
Optimum operating point			
Optimum speed	n_{opt}	rpm	3000
Optimum power	P_{opt}	kW	15.4
Limiting data			
Max. permissible speed (mech.)	$n_{max mech}$	rpm	8000
Max. permissible speed (inverter)	$n_{max Inv}$	rpm	6300
Maximum torque	M_{max}	Nm	125
Maximum current	I_{max}	A	111
Physical constants			
Torque constant	k_T	Nm/A	1.47
Voltage constant	k_E	V/1000 rpm	92
Winding resistance at 20 °C	R_{Str}	Ω	0.113
Rotating field inductance	L_D	mH	2.2
Electrical time constant	T_{el}	ms	19
Mechanical time constant	T_{mech}	ms	1.1
Thermal time constant	T_{th}	min	1.5
Shaft torsional stiffness	C_t	Nm/rad	57100
Weight with brake	m_{MotBr}	kg	37.1
Weight without brake	m_{Mot}	kg	34.1

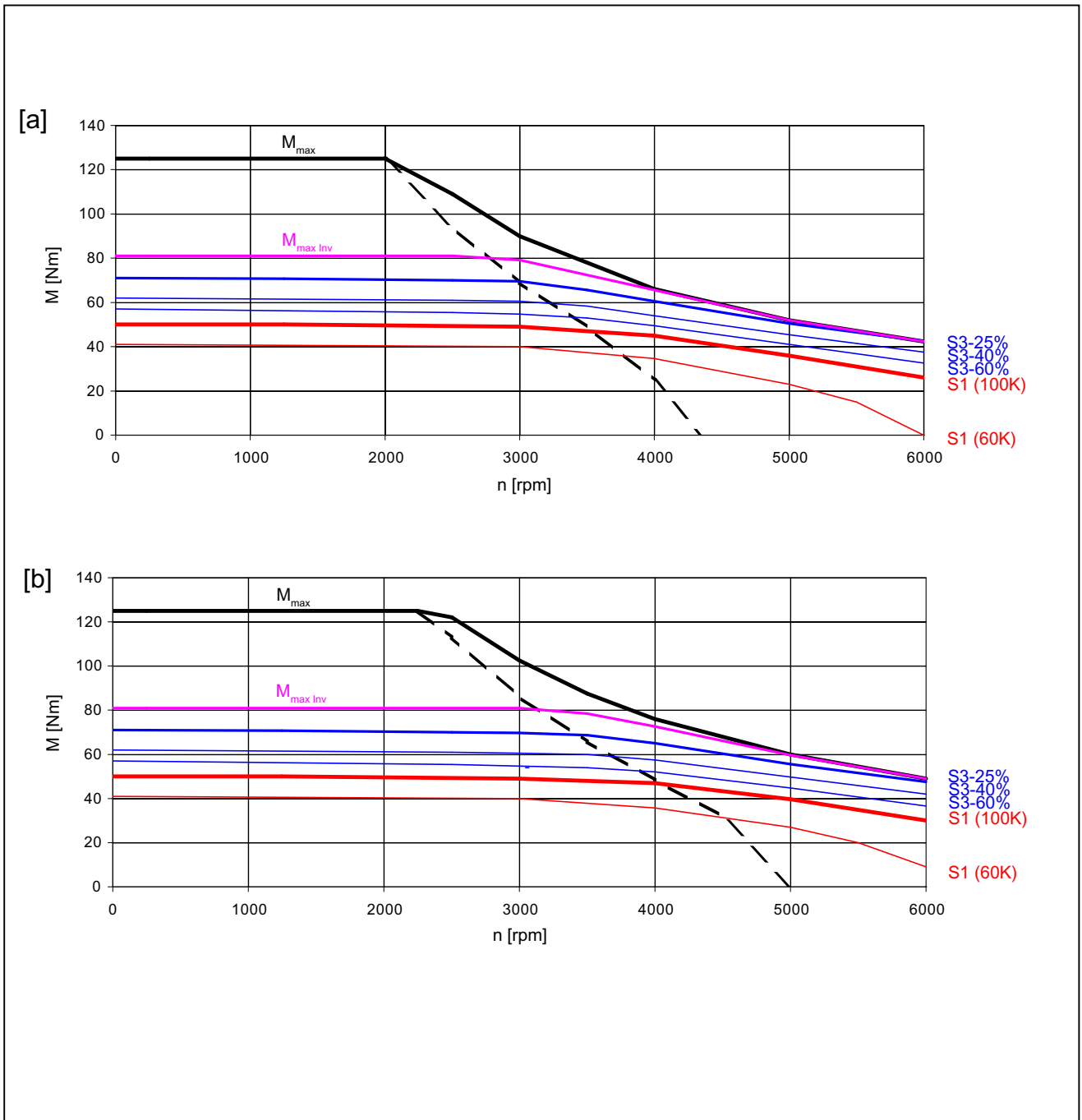

[a] SIMODRIVE 611 (UE), $V_{line} = 400$ V, $V_{mot} = 380$ V_{rms}

[b] SIMODRIVE 611 (UE), $V_{line} = 400$ V, $V_{mot} = 380$ V_{rms}

The characteristic curves are only valid for optimized inverter setting data

Figure 4-62 1FT7086-5WF7

4.2 Torque-speed characteristic

Table 4- 59 1FT7086-5WH7

Technical data	Code	Unit	Value
Configuration data			
Rated speed	n_N	rpm	4500
Number of poles	$2p$	---	10
Rated torque (100 K)	$M_N (100 K)$	Nm	43
Rated current (100 K)	$I_N (100 K)$	A	38
Static torque (60 K)	$M_0 (60 K)$	Nm	41
Static torque (100 K)	$M_0 (100 K)$	Nm	50
Stall current (60 K)	$I_0 (60 K)$	A	33.2
Stall current (100 K)	$I_0 (100 K)$	A	40.5
Moment of inertia (with brake)	J_{MotBr}	10^{-4} kgm^2	81.9
Moment of inertia (without brake)	J_{Mot}	10^{-4} kgm^2	67.8
Optimum operating point			
Optimum speed	n_{opt}	rpm	4500
Optimum power	P_{opt}	kW	20.3
Limiting data			
Max. permissible speed (mech.)	$n_{max \text{ mech}}$	rpm	8000
Max. permissible speed (inverter)	$n_{max \text{ Inv}}$	rpm	7500
Maximum torque	M_{max}	Nm	125
Maximum current	I_{max}	A	133
Physical constants			
Torque constant	k_T	Nm/A	1.24
Voltage constant	k_E	V/1000 rpm	77
Winding resistance at 20 °C	R_{Str}	Ω	0.085
Rotating field inductance	L_D	mH	1.5
Electrical time constant	T_{el}	ms	18
Mechanical time constant	T_{mech}	ms	1.1
Thermal time constant	T_{th}	min	1.5
Shaft torsional stiffness	C_t	Nm/rad	57100
Weight with brake	m_{MotBr}	kg	37.1
Weight without brake	m_{Mot}	kg	34.1

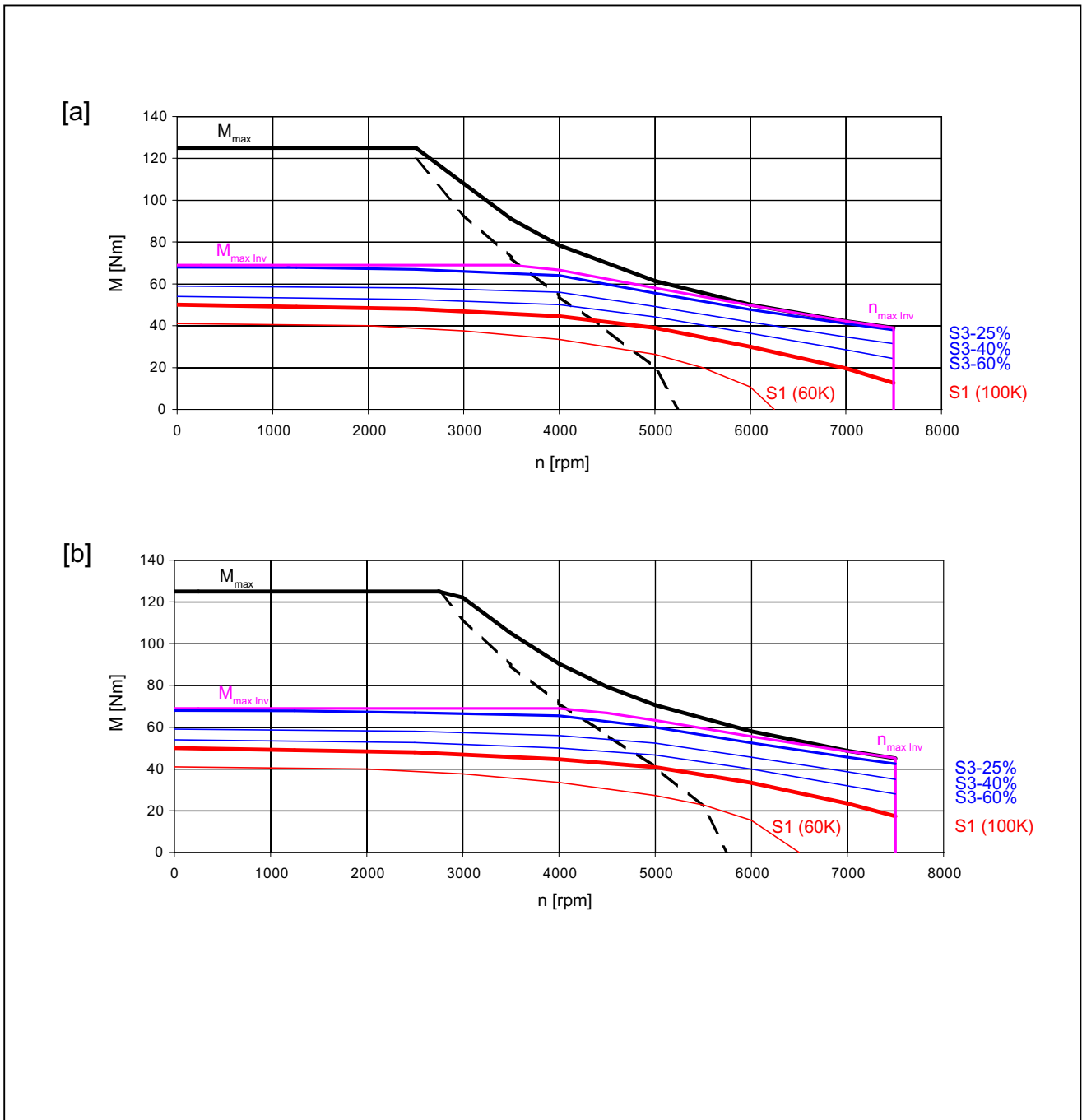
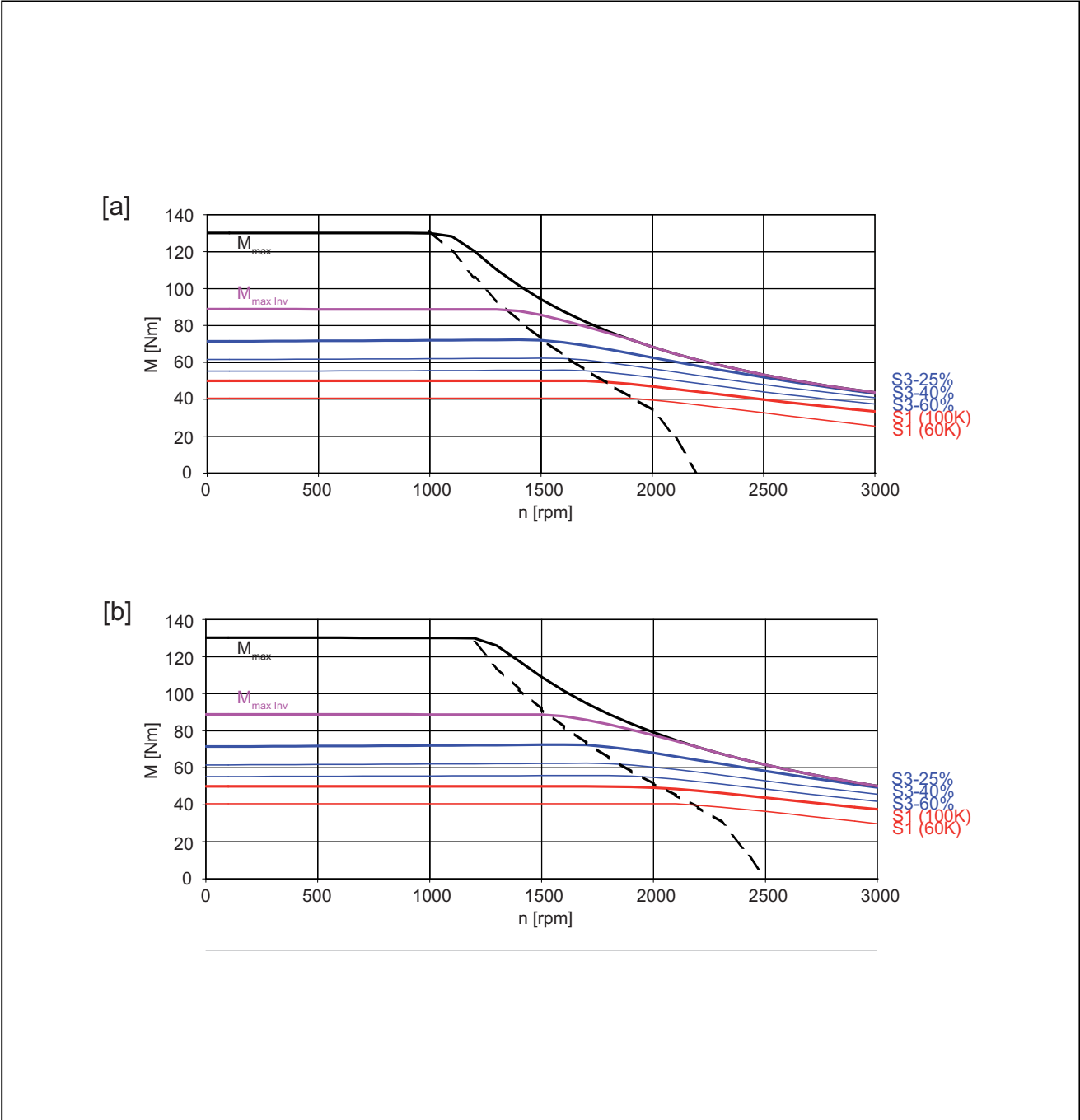

Figure 4-63 1FT7086-5WH7

4.2 Torque-speed characteristic

Table 4- 60 1FT7102-5WB7

Technical data	Code	Unit	Value
Configuration data			
Rated speed	n_N	rpm	1500
Number of poles	$2p$	---	10
Rated torque (100 K)	$M_N (100 K)$	Nm	50
Rated current (100 K)	$I_N (100 K)$	A	20.3
Static torque (60 K)	$M_0 (60 K)$	Nm	40
Static torque (100 K)	$M_0 (100 K)$	Nm	50
Stall current (60 K)	$I_0 (60 K)$	A	14.2
Stall current (100 K)	$I_0 (100 K)$	A	17.8
Moment of inertia (with brake)	J_{MotBr}	10^{-4} kgm ²	125
Moment of inertia (without brake)	J_{Mot}	10^{-4} kgm ²	98.9
Optimum operating point			
Optimum speed	n_{opt}	rpm	1500
Optimum power	P_{opt}	kW	7.85
Limiting data			
Max. permissible speed (mech.)	$n_{max mech}$	rpm	6000
Max. permissible speed (inverter)	$n_{max Inv}$	rpm	3200
Maximum torque	M_{max}	Nm	130
Maximum current	I_{max}	A	59
Physical constants			
Torque constant	k_T	Nm/A	2.81
Voltage constant	k_E	V/1000 rpm	179
Winding resistance at 20 °C	R_{Str}	Ω	0.31
Rotating field inductance	L_D	mH	6.2
Electrical time constant	T_{el}	ms	20
Mechanical time constant	T_{mech}	ms	1.2
Thermal time constant	T_{th}	min	1.5
Shaft torsional stiffness	C_t	Nm/rad	124000
Weight with brake	m_{MotBr}	kg	40.9
Weight without brake	m_{Mot}	kg	36.6



[a] SIMODRIVE 611 (UE), $V_{line} = 400\text{ V}$, $V_{mot} = 380\text{ V}_{rms}$
 [b] SIMODRIVE 611 (ER), $V_{line} = 400\text{ V}$, $V_{mot} = 425\text{ V}_{rms}$
 The characteristic curves are only valid for optimized inverter setting data

Figure 4-64 1FT7102-5WB7

4.2 Torque-speed characteristic

Table 4- 61 1FT7102-5WC7

Technical data	Code	Unit	Value
Configuration data			
Rated speed	n_N	rpm	2000
Number of poles	$2p$	---	10
Rated torque (100 K)	$M_N (100 K)$	Nm	49.5
Rated current (100 K)	$I_N (100 K)$	A	29.3
Static torque (60 K)	$M_0 (60 K)$	Nm	40
Static torque (100 K)	$M_0 (100 K)$	Nm	50
Stall current (60 K)	$I_0 (60 K)$	A	20.4
Stall current (100 K)	$I_0 (100 K)$	A	25.5
Moment of inertia (with brake)	J_{MotBr}	10^{-4} kgm^2	125
Moment of inertia (without brake)	J_{Mot}	10^{-4} kgm^2	98.9
Optimum operating point			
Optimum speed	n_{opt}	rpm	2000
Optimum power	P_{opt}	kW	10.4
Limiting data			
Max. permissible speed (mech.)	$n_{max mech}$	rpm	6000
Max. permissible speed (inverter)	$n_{max Inv}$	rpm	4700
Maximum torque	M_{max}	Nm	130
Maximum current	I_{max}	A	84.5
Physical constants			
Torque constant	k_T	Nm/A	1.96
Voltage constant	k_E	V/1000 rpm	124
Winding resistance at 20 °C	R_{Str}	Ω	0.15
Rotating field inductance	L_D	mH	3.0
Electrical time constant	T_{el}	ms	20
Mechanical time constant	T_{mech}	ms	1.1
Thermal time constant	T_{th}	min	1.5
Shaft torsional stiffness	C_t	Nm/rad	124000
Weight with brake	m_{MotBr}	kg	40.9
Weight without brake	m_{Mot}	kg	36.6

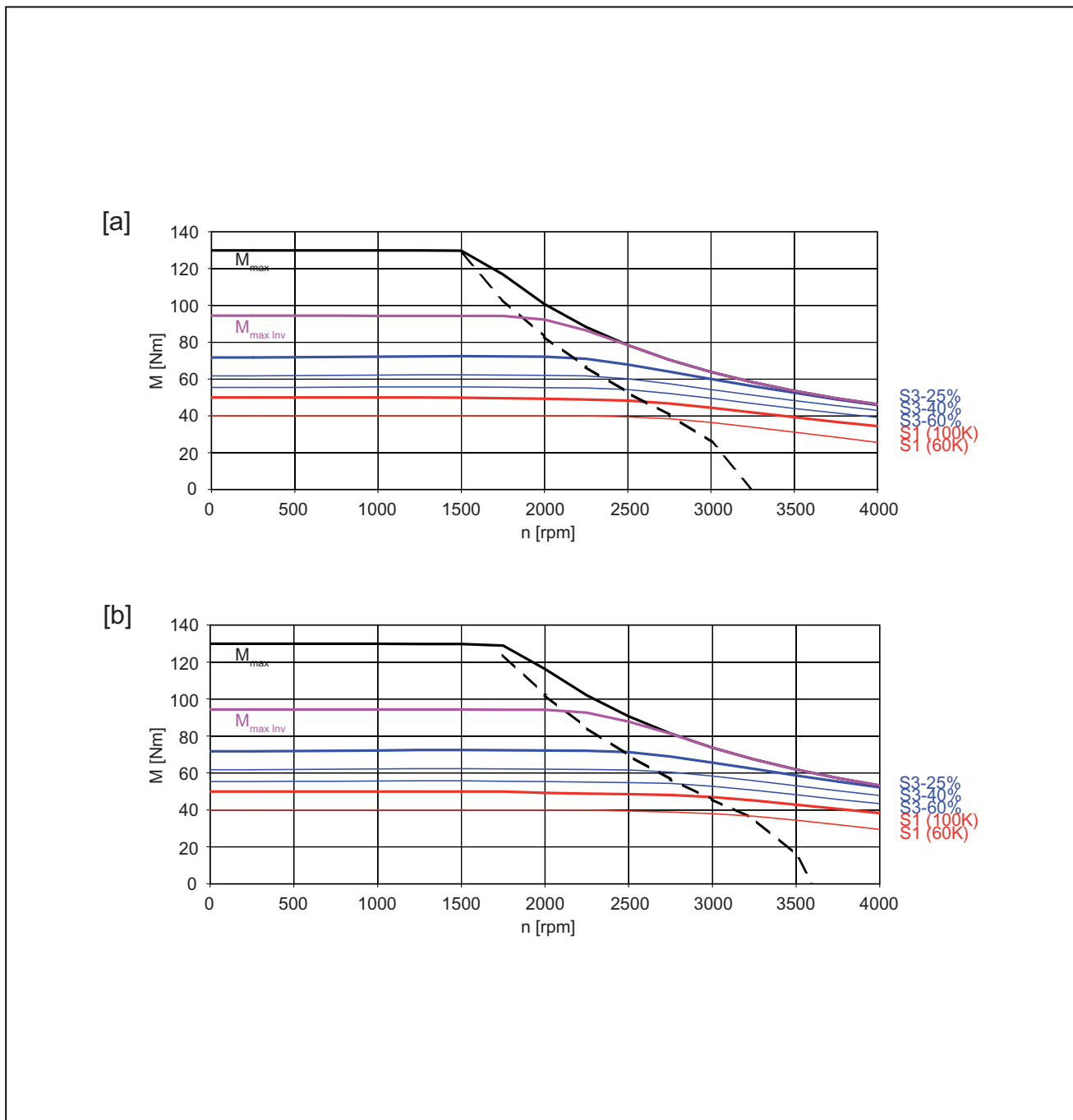

[a] SIMODRIVE 611 (UE), $V_{line} = 400\text{ V}$, $V_{mot} = 380\text{ V}_{rms}$

[b] SIMODRIVE 611 (ER), $V_{line} = 400\text{ V}$, $V_{mot} = 425\text{ V}_{rms}$

The characteristic curves are only valid for optimized inverter setting data

Figure 4-65 1FT7102-5WC7

4.2 Torque-speed characteristic

Table 4- 62 1FT7102-5WF7

Technical data	Code	Unit	Value
Configuration data			
Rated speed	n_N	rpm	3000
Number of poles	$2p$	---	10
Rated torque (100 K)	$M_N (100 K)$	Nm	45.5
Rated current (100 K)	$I_N (100 K)$	A	38.8
Static torque (60 K)	$M_0 (60 K)$	Nm	40
Static torque (100 K)	$M_0 (100 K)$	Nm	50
Stall current (60 K)	$I_0 (60 K)$	A	32.0
Stall current (100 K)	$I_0 (100 K)$	A	40.0
Moment of inertia (with brake)	J_{MotBr}	10^{-4} kgm ²	125
Moment of inertia (without brake)	J_{Mot}	10^{-4} kgm ²	98.9
Optimum operating point			
Optimum speed	n_{opt}	rpm	3000
Optimum power	P_{opt}	kW	14.3
Limiting data			
Max. permissible speed (mech.)	$n_{max mech}$	rpm	6000
Max. permissible speed (inverter)	$n_{max Inv}$	rpm	6000
Maximum torque	M_{max}	Nm	130
Maximum current	I_{max}	A	135
Physical constants			
Torque constant	k_T	Nm/A	1.25
Voltage constant	k_E	V/1000 rpm	78
Winding resistance at 20 °C	R_{Str}	Ω	0.06
Rotating field inductance	L_D	mH	1.18
Electrical time constant	T_{el}	ms	20
Mechanical time constant	T_{mech}	ms	1.1
Thermal time constant	T_{th}	min	1.5
Shaft torsional stiffness	C_t	Nm/rad	124000
Weight with brake	m_{MotBr}	kg	40.9
Weight without brake	m_{Mot}	kg	36.6

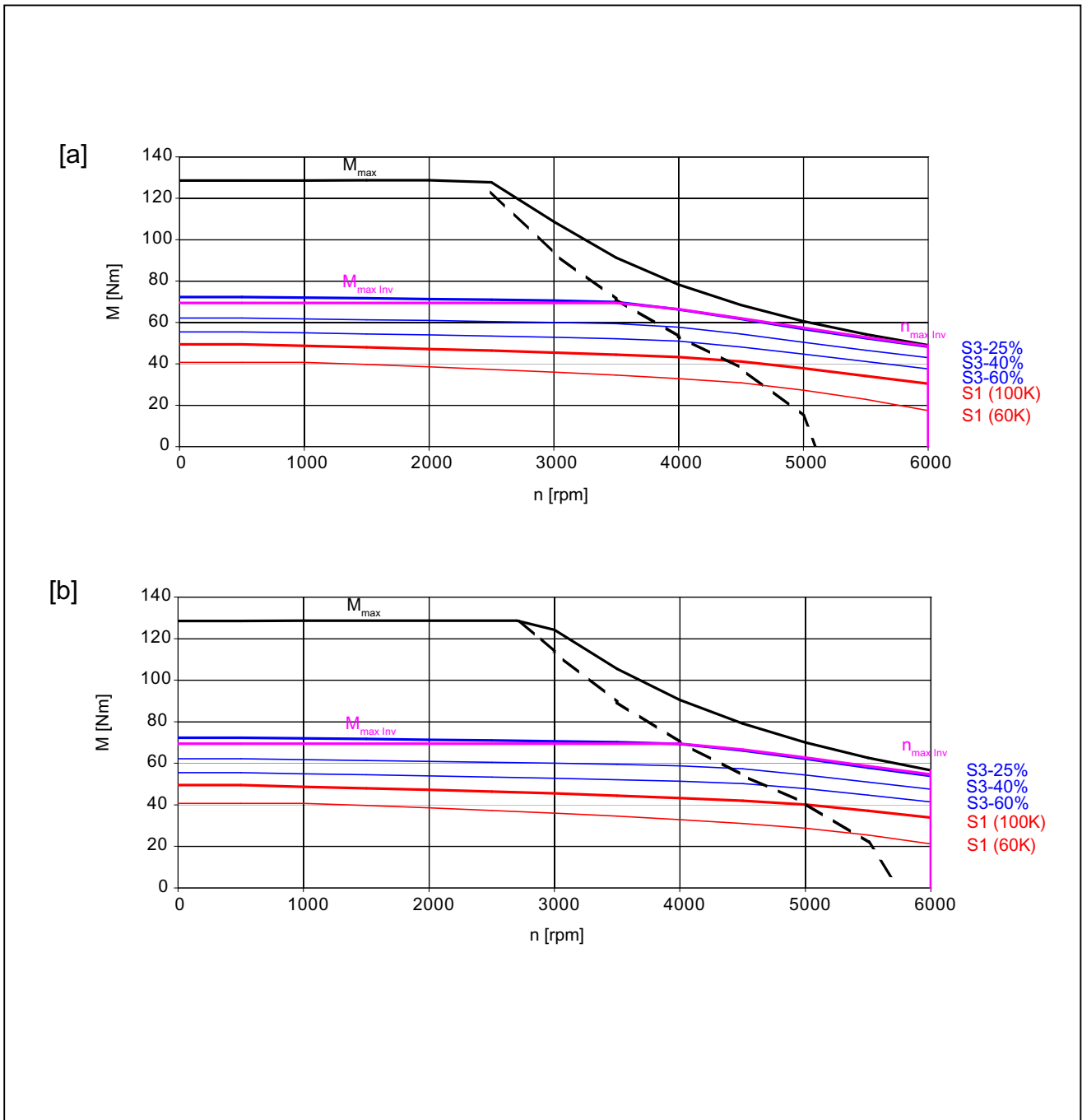

4.2 Torque-speed characteristic

Table 4- 63 1FT7105-5WB7

Technical data	Code	Unit	Value
Configuration data			
Rated speed	n_N	rpm	1500
Number of poles	$2p$	---	10
Rated torque (100 K)	$M_N (100 K)$	Nm	90
Rated current (100 K)	$I_N (100 K)$	A	29.5
Static torque (60 K)	$M_0 (60 K)$	Nm	72
Static torque (100 K)	$M_0 (100 K)$	Nm	90
Stall current (60 K)	$I_0 (60 K)$	A	22.5
Stall current (100 K)	$I_0 (100 K)$	A	28.2
Moment of inertia (with brake)	J_{MotBr}	10^{-4} kgm^2	217
Moment of inertia (without brake)	J_{Mot}	10^{-4} kgm^2	191.0
Optimum operating point			
Optimum speed	n_{opt}	rpm	1500
Optimum power	P_{opt}	kW	14.1
Limiting data			
Max. permissible speed (mech.)	$n_{max mech}$	rpm	6000
Max. permissible speed (inverter)	$n_{max Inv}$	rpm	2900
Maximum torque	M_{max}	Nm	230
Maximum current	I_{max}	A	87
Physical constants			
Torque constant	k_T	Nm/A	3.19
Voltage constant	k_E	V/1000 rpm	198
Winding resistance at 20 °C	R_{Str}	Ω	0.16
Rotating field inductance	L_D	mH	3.67
Electrical time constant	T_{el}	ms	24
Mechanical time constant	T_{mech}	ms	0.9
Thermal time constant	T_{th}	min	1.5
Shaft torsional stiffness	C_t	Nm/rad	106000
Weight with brake	m_{MotBr}	kg	59.1
Weight without brake	m_{Mot}	kg	54.8

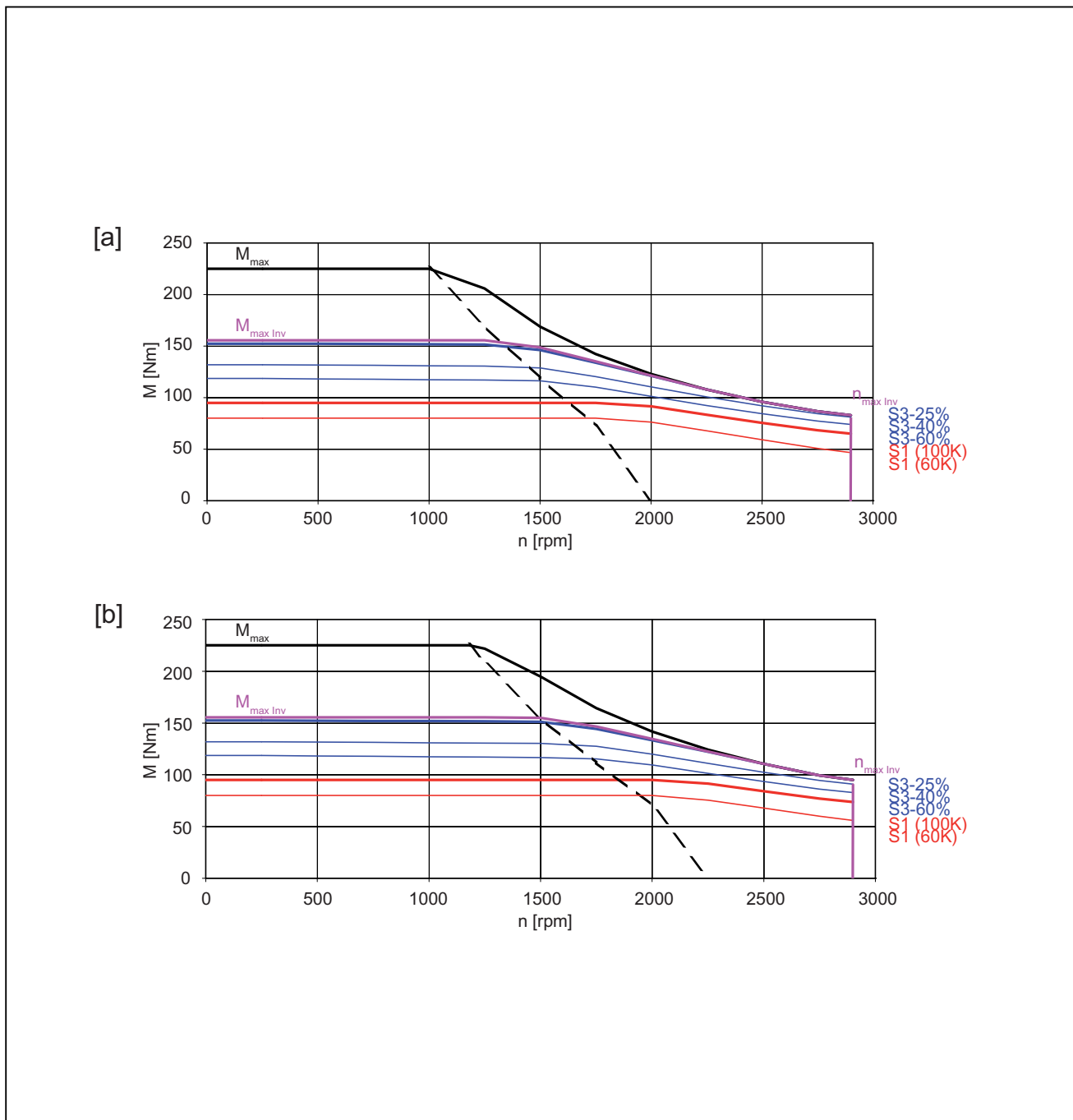

[a] SIMODRIVE 611 (UE), $V_{line} = 400 \text{ V}$, $V_{mot} = 380 \text{ V}_{rms}$

[b] SIMODRIVE 611 (ER), $V_{line} = 400 \text{ V}$, $V_{mot} = 425 \text{ V}_{rms}$

The characteristic curves are only valid for optimized inverter setting data

Figure 4-67 1FT7105-5WB7

4.2 Torque-speed characteristic

Table 4- 64 1FT7105-5WC7

Technical data	Code	Unit	Value
Configuration data			
Rated speed	n_N	rpm	2000
Number of poles	$2p$	---	10
Rated torque (100 K)	$M_N (100 K)$	Nm	90
Rated current (100 K)	$I_N (100 K)$	A	40.8
Static torque (60 K)	$M_0 (60 K)$	Nm	72
Static torque (100 K)	$M_0 (100 K)$	Nm	90
Stall current (60 K)	$I_0 (60 K)$	A	31.2
Stall current (100 K)	$I_0 (100 K)$	A	39.0
Moment of inertia (with brake)	J_{MotBr}	10^{-4} kgm^2	217
Moment of inertia (without brake)	J_{Mot}	10^{-4} kgm^2	191.0
Optimum operating point			
Optimum speed	n_{opt}	rpm	2000
Optimum power	P_{opt}	kW	18.8
Limiting data			
Max. permissible speed (mech.)	$n_{max mech}$	rpm	6000
Max. permissible speed (inverter)	$n_{max Inv}$	rpm	4100
Maximum torque	M_{max}	Nm	230
Maximum current	I_{max}	A	120.5
Physical constants			
Torque constant	k_T	Nm/A	2.31
Voltage constant	k_E	V/1000 rpm	143
Winding resistance at 20 °C	R_{Str}	Ω	0.084
Rotating field inductance	L_D	mH	1.92
Electrical time constant	T_{el}	ms	23
Mechanical time constant	T_{mech}	ms	0.9
Thermal time constant	T_{th}	min	1.5
Shaft torsional stiffness	C_t	Nm/rad	106000
Weight with brake	m_{MotBr}	kg	59.1
Weight without brake	m_{Mot}	kg	54.8

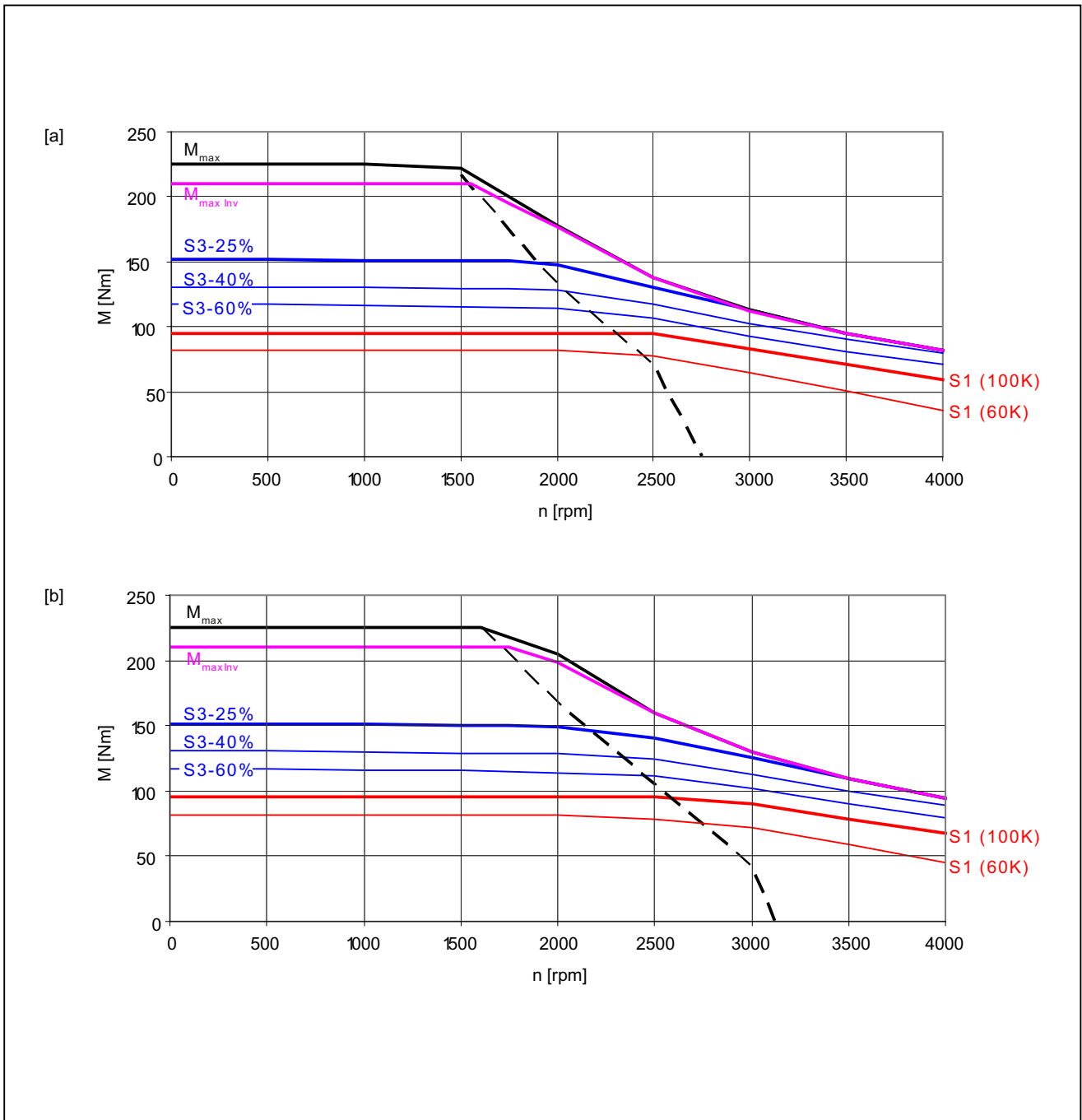

[a] SIMODRIVE 611 (UE), $V_{line} = 400$ V, $V_{mot} = 380$ V_{rms}

[b] SIMODRIVE 611 (ER), $V_{line} = 400$ V, $V_{mot} = 425$ V_{rms}

The characteristic curves are only valid for optimized inverter setting data

Figure 4-68 1FT7105-5WC7

4.2 Torque-speed characteristic

Table 4- 65 1FT7105-5WF7

Technical data	Code	Unit	Value
Configuration data			
Rated speed	n_N	rpm	3000
Number of poles	$2p$	---	10
Rated torque (100 K)	$M_N (100 K)$	Nm	79
Rated current (100 K)	$I_N (100 K)$	A	49.5
Static torque (60 K)	$M_0 (60 K)$	Nm	72
Static torque (100 K)	$M_0 (100 K)$	Nm	90
Stall current (60 K)	$I_0 (60 K)$	A	42.5
Stall current (100 K)	$I_0 (100 K)$	A	53.2
Moment of inertia (with brake)	J_{MotBr}	10^{-4} kgm^2	217
Moment of inertia (without brake)	J_{Mot}	10^{-4} kgm^2	191.0
Optimum operating point			
Optimum speed	n_{opt}	rpm	3000
Optimum power	P_{opt}	kW	24.8
Limiting data			
Max. permissible speed (mech.)	$n_{max mech}$	rpm	6000
Max. permissible speed (inverter)	$n_{max Inv}$	rpm	5500
Maximum torque	M_{max}	Nm	230
Maximum current	I_{max}	A	164
Physical constants			
Torque constant	k_T	Nm/A	1.69
Voltage constant	k_E	V/1000 rpm	105
Winding resistance at 20 °C	R_{Str}	Ω	0.049
Rotating field inductance	L_D	mH	1.04
Electrical time constant	T_{el}	ms	21
Mechanical time constant	T_{mech}	ms	1.0
Thermal time constant	T_{th}	min	1.5
Shaft torsional stiffness	C_t	Nm/rad	106000
Weight with brake	m_{MotBr}	kg	59.1
Weight without brake	m_{Mot}	kg	54.8

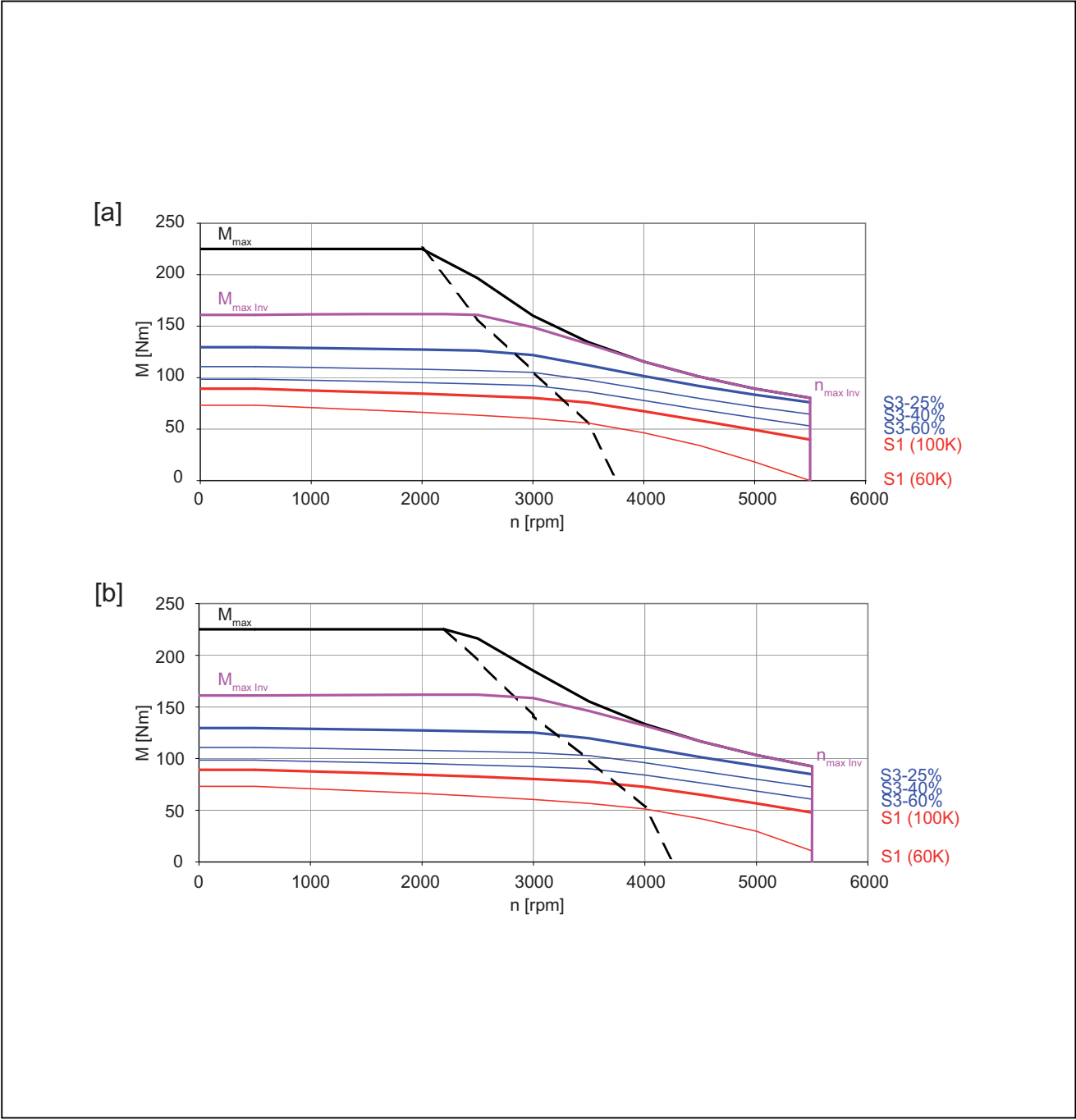

[a] SIMODRIVE 611 (UE), $V_{line} = 400 V$, $V_{mot} = 380 V_{rms}$

[b] SIMODRIVE 611 (ER), $V_{line} = 400 V$, $V_{mot} = 425 V_{rms}$

The characteristic curves are only valid for optimized inverter setting data

Figure 4-69 1FT7105-5WF7

4.2 Torque-speed characteristic

Table 4- 66 1FT7108-5WB7

Technical data	Code	Unit	Value
Configuration data			
Rated speed	n_N	rpm	1500
Number of poles	$2p$	---	10
Rated torque (100 K)	$M_N (100 K)$	Nm	125
Rated current (100 K)	$I_N (100 K)$	A	40.3
Static torque (60 K)	$M_0 (60 K)$	Nm	100
Static torque (100 K)	$M_0 (100 K)$	Nm	125
Stall current (60 K)	$I_0 (60 K)$	A	31.2
Stall current (100 K)	$I_0 (100 K)$	A	39.0
Moment of inertia (with brake)	J_{MotBr}	10^{-4} kgm ²	291
Moment of inertia (without brake)	J_{Mot}	10^{-4} kgm ²	265.0
Optimum operating point			
Optimum speed	n_{opt}	rpm	1500
Optimum power	P_{opt}	kW	19.6
Limiting data			
Max. permissible speed (mech.)	$n_{max mech}$	rpm	6000
Max. permissible speed (inverter)	$n_{max Inv}$	rpm	2900
Maximum torque	M_{max}	Nm	330
Maximum current	I_{max}	A	120.5
Physical constants			
Torque constant	k_T	Nm/A	3.21
Voltage constant	k_E	V/1000 rpm	200
Winding resistance at 20 °C	R_{Str}	Ω	0.111
Rotating field inductance	L_D	mH	2.65
Electrical time constant	T_{el}	ms	24
Mechanical time constant	T_{mech}	ms	0.9
Thermal time constant	T_{th}	min	1.5
Shaft torsional stiffness	C_t	Nm/rad	96000
Weight with brake	m_{MotBr}	kg	72.9
Weight without brake	m_{Mot}	kg	68.6

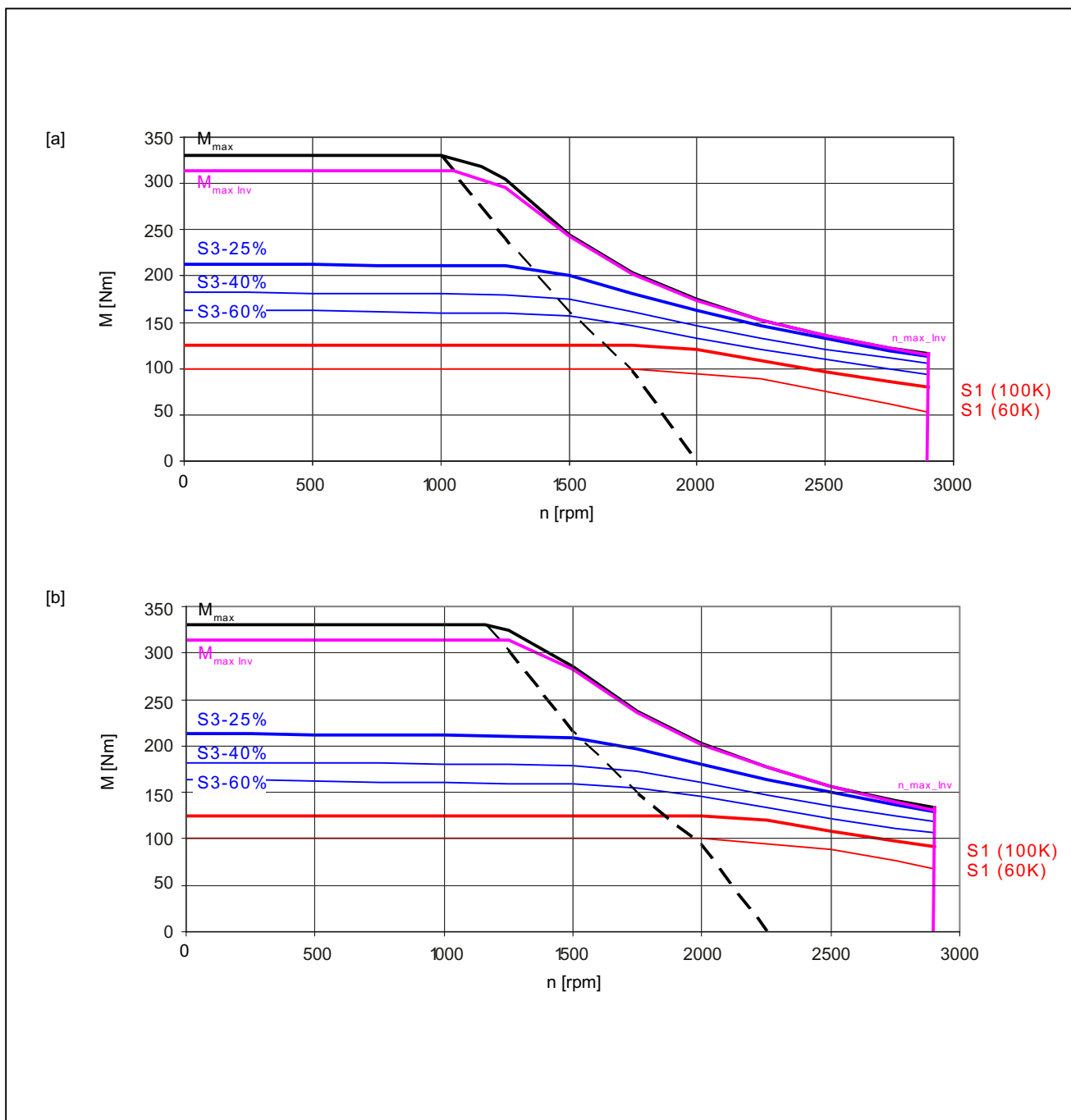

[a] SIMODRIVE 611 (UE), $V_{line} = 400 \text{ V}$, $V_{mot} = 380 \text{ V}_{rms}$

[b] SIMODRIVE 611 (ER), $V_{line} = 400 \text{ V}$, $V_{mot} = 425 \text{ V}_{rms}$

The characteristic curves are only valid for optimized inverter setting data

Figure 4-70 1FT7108-5WB7

4.2 Torque-speed characteristic

Table 4- 67 1FT7108-5WC7

Technical data	Code	Unit	Value
Configuration data			
Rated speed	n_N	rpm	2000
Number of poles	$2p$	---	10
Rated torque (100 K)	$M_N (100 K)$	Nm	125
Rated current (100 K)	$I_N (100 K)$	A	47.5
Static torque (60 K)	$M_0 (60 K)$	Nm	100
Static torque (100 K)	$M_0 (100 K)$	Nm	125
Stall current (60 K)	$I_0 (60 K)$	A	36.2
Stall current (100 K)	$I_0 (100 K)$	A	45.3
Moment of inertia (with brake)	J_{MotBr}	10^{-4} kgm ²	291
Moment of inertia (without brake)	J_{Mot}	10^{-4} kgm ²	265.0
Optimum operating point			
Optimum speed	n_{opt}	rpm	2000
Optimum power	P_{opt}	kW	26.2
Limiting data			
Max. permissible speed (mech.)	$n_{max mech}$	rpm	6000
Max. permissible speed (inverter)	$n_{max Inv}$	rpm	3400
Maximum torque	M_{max}	Nm	330
Maximum current	I_{max}	A	141.5
Physical constants			
Torque constant	k_T	Nm/A	2.76
Voltage constant	k_E	V/1000 rpm	171
Winding resistance at 20 °C	R_{Str}	Ω	0.081
Rotating field inductance	L_D	mH	1.93
Electrical time constant	T_{el}	ms	24
Mechanical time constant	T_{mech}	ms	0.8
Thermal time constant	T_{th}	min	1.5
Shaft torsional stiffness	C_t	Nm/rad	96000
Weight with brake	m_{MotBr}	kg	72.9
Weight without brake	m_{Mot}	kg	68.6

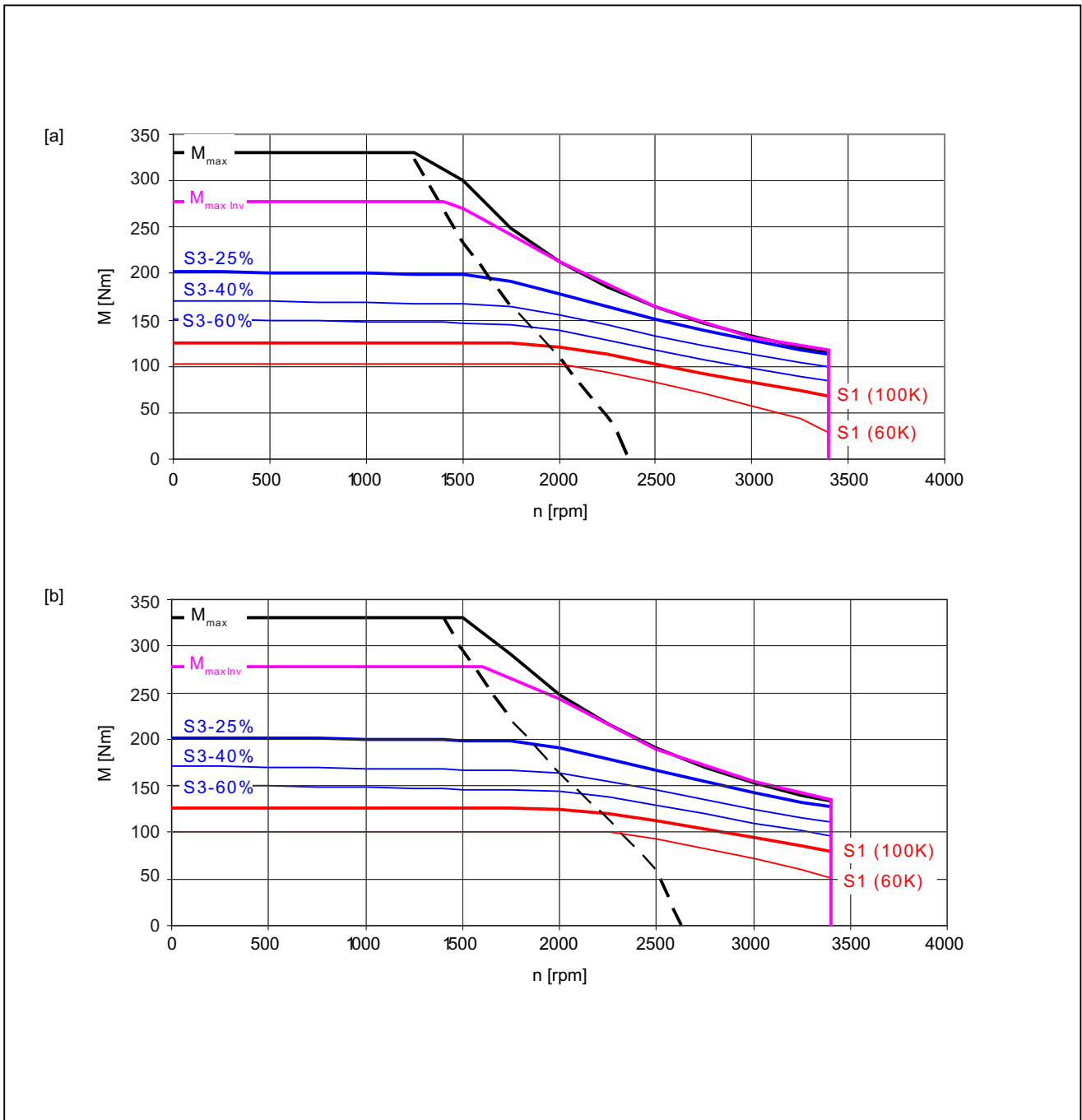

[a] SIMODRIVE 611 (UE), $V_{line} = 400 \text{ V}$, $V_{mot} = 380 \text{ V}_{rms}$

[b] SIMODRIVE 611 (ER), $V_{line} = 400 \text{ V}$, $V_{mot} = 425 \text{ V}_{rms}$

The characteristic curves are only valid for optimized inverter setting data

Figure 4-71 1FT7108-5WC7

4.2 Torque-speed characteristic

Table 4- 68 1FT7108-5WF7

Technical data	Code	Unit	Value
Configuration data			
Rated speed	n_N	rpm	3000
Number of poles	$2p$	---	10
Rated torque (100 K)	$M_N (100 K)$	Nm	109
Rated current (100 K)	$I_N (100 K)$	A	60.0
Static torque (60 K)	$M_0 (60 K)$	Nm	100
Static torque (100 K)	$M_0 (100 K)$	Nm	125
Stall current (60 K)	$I_0 (60 K)$	A	52.0
Stall current (100 K)	$I_0 (100 K)$	A	65.0
Moment of inertia (with brake)	J_{MotBr}	10^{-4} kgm ²	291
Moment of inertia (without brake)	J_{Mot}	10^{-4} kgm ²	265.0
Optimum operating point			
Optimum speed	n_{opt}	rpm	3000
Optimum power	P_{opt}	kW	34.2
Limiting data			
Max. permissible speed (mech.)	$n_{max mech}$	rpm	6000
Max. permissible speed (inverter)	$n_{max Inv}$	rpm	4900
Maximum torque	M_{max}	Nm	330
Maximum current	I_{max}	A	205
Physical constants			
Torque constant	k_T	Nm/A	1.92
Voltage constant	k_E	V/1000 rpm	118
Winding resistance at 20 °C	R_{Str}	Ω	0.042
Rotating field inductance	L_D	mH	0.92
Electrical time constant	T_{el}	ms	22
Mechanical time constant	T_{mech}	ms	0.9
Thermal time constant	T_{th}	min	1.5
Shaft torsional stiffness	C_t	Nm/rad	96000
Weight with brake	m_{MotBr}	kg	72.9
Weight without brake	m_{Mot}	kg	68.6

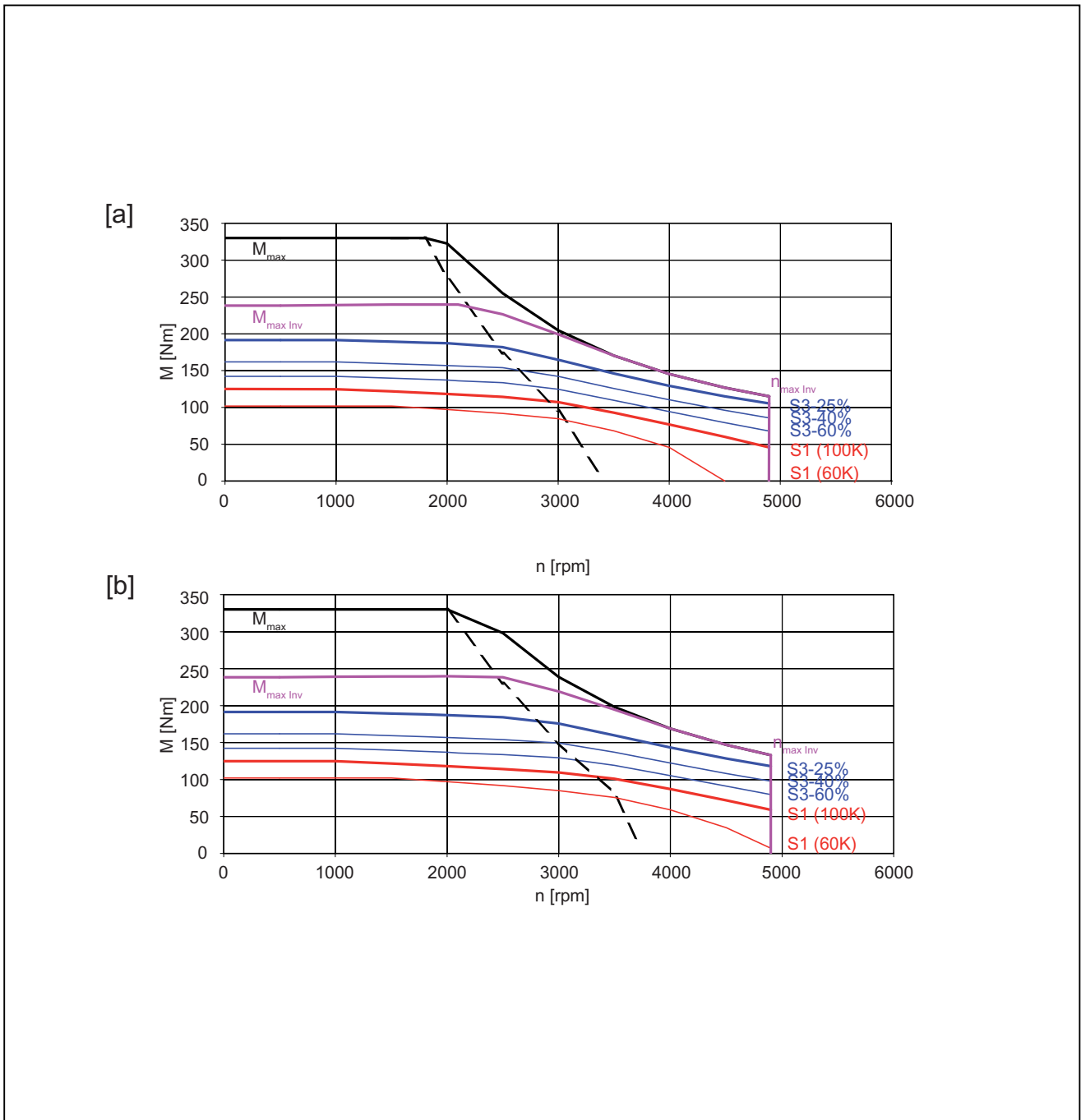

[a] SIMODRIVE 611 (UE), $V_{line} = 400$ V, $V_{mot} = 380$ V_{rms}

[b] SIMODRIVE 611 (ER), $V_{line} = 400$ V, $V_{mot} = 425$ V_{rms}

The characteristic curves are only valid for optimized inverter setting data

Figure 4-72 1FT7108-5WF7

4.2 Torque-speed characteristic

4.2.4 1FT7 High Dynamic synchronous motors, forced ventilation

Table 4- 69 1FT7065-7SF7

Technical data	Code	Unit	Value
Configuration data			
Rated speed	n_N	rpm	3000
Number of poles	$2p$	---	6
Rated torque (100 K)	$M_N (100\text{ K})$	Nm	12
Rated current (100 K)	$I_N (100\text{ K})$	A	10.5
Static torque (60 K)	$M_0 (60\text{ K})$	Nm	11
Static torque (100 K)	$M_0 (100\text{ K})$	Nm	14
Stall current (60 K)	$I_0 (60\text{ K})$	A	9.5
Stall current (100 K)	$I_0 (100\text{ K})$	A	12
Moment of inertia (with brake)	J_{MotBr}	10^{-4} kgm^2	9
Moment of inertia (without brake)	J_{Mot}	10^{-4} kgm^2	6.4
Optimum operating point			
Optimum speed	n_{opt}	rpm	3000
Optimum power	P_{opt}	kW	3.8
Limiting data			
Max. permissible speed (mech.)	$n_{max\ mech}$	rpm	9000
Max. permissible speed (inverter)	$n_{max\ Inv}$	rpm	7700
Maximum torque	M_{max}	Nm	45
Maximum current	I_{max}	A	49
Physical constants			
Torque constant	k_T	Nm/A	1.17
Voltage constant	k_E	V/1000 rpm	75
Winding resistance at 20 °C	R_{Str}	Ω	0.45
Rotating field inductance	L_D	mH	8.3
Electrical time constant	T_{el}	ms	18
Mechanical time constant	T_{mech}	ms	0.6
Thermal time constant	T_{th}	min	20
Shaft torsional stiffness	C_t	Nm/rad	27500
Weight with brake	m_{MotBr}	kg	20
Weight without brake	m_{Mot}	kg	19

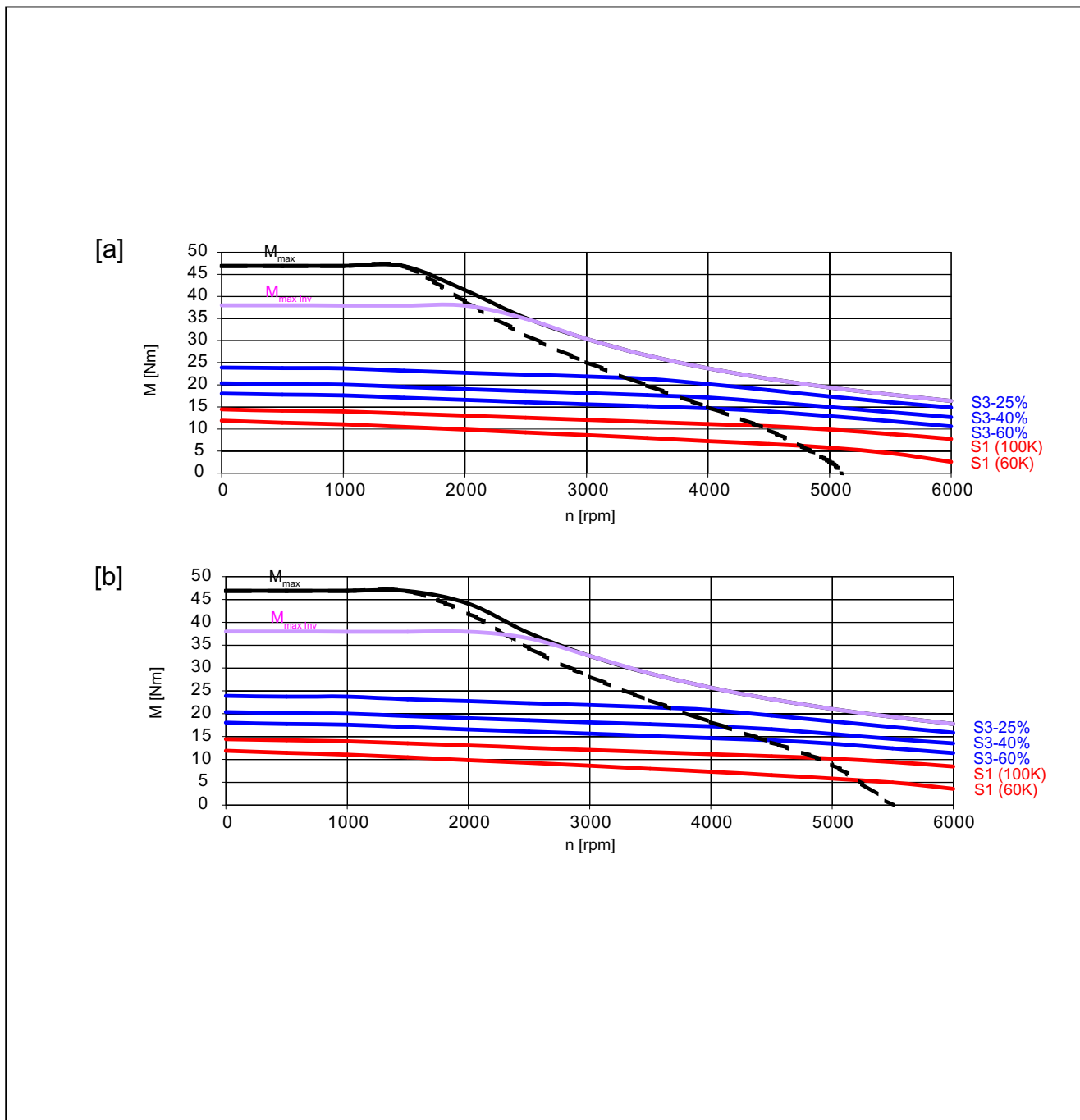

[a] SIMODRIVE 611 (UE) 400 V

[b] SIMODRIVE 611 (E/R) 400 V

The characteristic curves are only valid for optimized inverter setting data

Figure 4-73 1FT7065-7SF7

4.2 Torque-speed characteristic

Table 4- 70 1FT7065-7SH7

Technical data	Code	Unit	Value
Configuration data			
Rated speed	n_N	rpm	4500
Number of poles	2p	---	6
Rated torque (100 K)	$M_N (100\text{ K})$	Nm	11
Rated current (100 K)	$I_N (100\text{ K})$	A	13.5
Static torque (60 K)	$M_0 (60\text{ K})$	Nm	11
Static torque (100 K)	$M_0 (100\text{ K})$	Nm	14
Stall current (60 K)	$I_0 (60\text{ K})$	A	13
Stall current (100 K)	$I_0 (100\text{ K})$	A	16
Moment of inertia (with brake)	J_{MotBr}	10^{-4} kgm^2	9
Moment of inertia (without brake)	J_{Mot}	10^{-4} kgm^2	6.4
Optimum operating point			
Optimum speed	n_{opt}	rpm	4500
Optimum power	P_{opt}	kW	5.2
Limiting data			
Max. permissible speed (mech.)	$n_{max\ mech}$	rpm	9000
Max. permissible speed (inverter)	$n_{max\ Inv}$	rpm	9000
Maximum torque	M_{max}	Nm	45
Maximum current	I_{max}	A	67
Physical constants			
Torque constant	k_T	Nm/A	0.86
Voltage constant	k_E	V/1000 rpm	55
Winding resistance at 20 °C	R_{Str}	Ω	0.23
Rotating field inductance	L_D	mH	4.4
Electrical time constant	T_{el}	ms	19
Mechanical time constant	T_{mech}	ms	0.6
Thermal time constant	T_{th}	min	20
Shaft torsional stiffness	c_t	Nm/rad	27500
Weight with brake	m_{MotBr}	kg	20
Weight without brake	m_{Mot}	kg	19

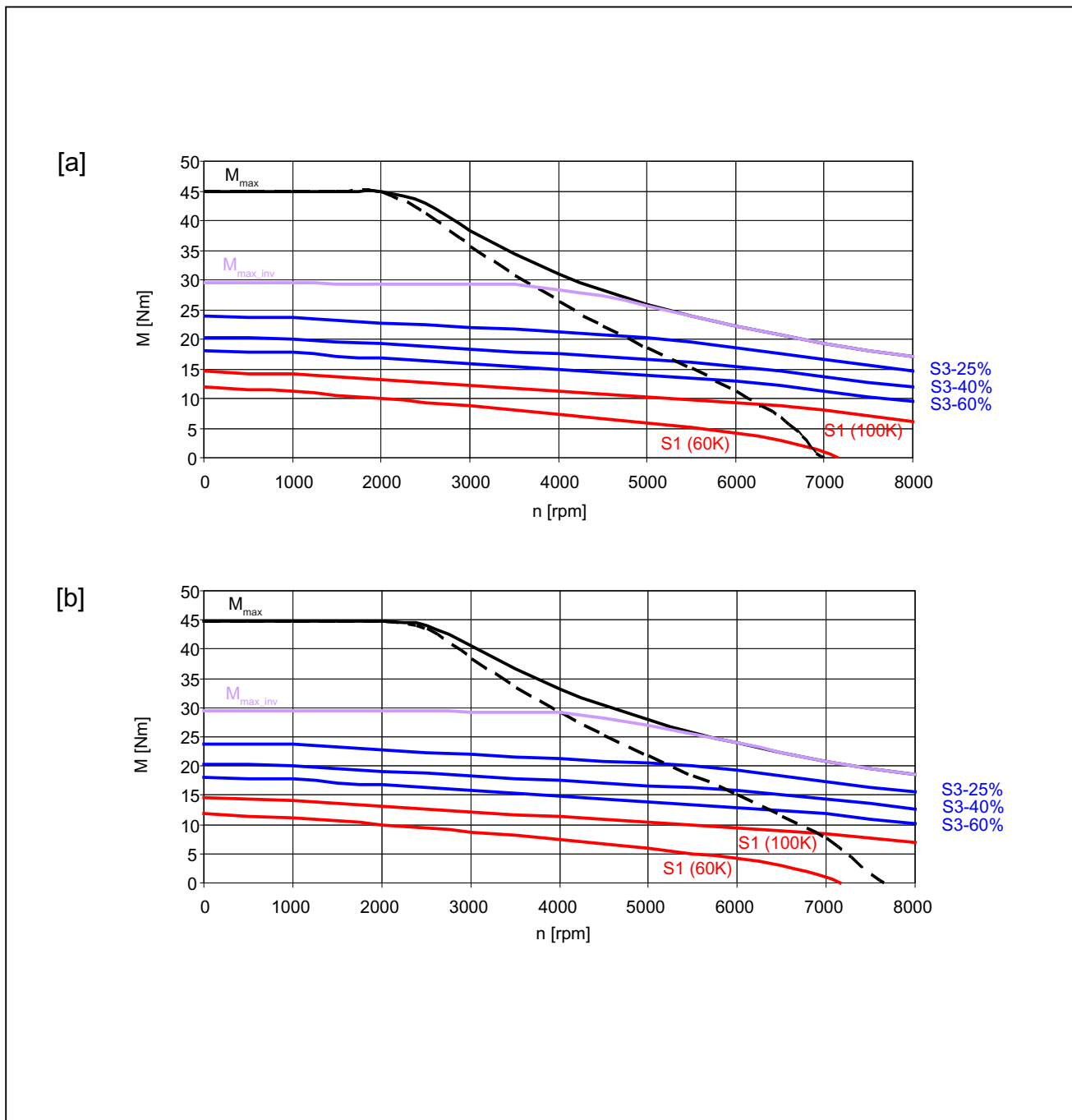

[a] SIMODRIVE 611 (UE) 400 V

[b] SIMODRIVE 611 (E/R) 400 V

The characteristic curves are only valid for optimized inverter setting data

Figure 4-74 1FT7065-7SH7

4.2 Torque-speed characteristic

Table 4- 71 1FT7067-7SF7

Technical data	Code	Unit	Value
Configuration data			
Rated speed	n_N	rpm	3000
Number of poles	$2p$	---	6
Rated torque (100 K)	$M_N (100 K)$	Nm	14
Rated current (100 K)	$I_N (100 K)$	A	13
Static torque (60 K)	$M_0 (60 K)$	Nm	14
Static torque (100 K)	$M_0 (100 K)$	Nm	17
Stall current (60 K)	$I_0 (60 K)$	A	12.5
Stall current (100 K)	$I_0 (100 K)$	A	15
Moment of inertia (with brake)	J_{MotBr}	10^{-4} kgm ²	10.9
Moment of inertia (without brake)	J_{Mot}	10^{-4} kgm ²	8.3
Optimum operating point			
Optimum speed	n_{opt}	rpm	3000
Optimum power	P_{opt}	kW	4.4
Limiting data			
Max. permissible speed (mech.)	$n_{max mech}$	rpm	9000
Max. permissible speed (inverter)	$n_{max Inv}$	rpm	7900
Maximum torque	M_{max}	Nm	60
Maximum current	I_{max}	A	63
Physical constants			
Torque constant	k_T	Nm/A	1.14
Voltage constant	k_E	V/1000 rpm	73
Winding resistance at 20 °C	R_{Str}	Ω	0.3
Rotating field inductance	L_D	mH	5.7
Electrical time constant	T_{el}	ms	19
Mechanical time constant	T_{mech}	ms	0.6
Thermal time constant	T_{th}	min	20
Shaft torsional stiffness	C_t	Nm/rad	21600
Weight with brake	m_{MotBr}	kg	24
Weight without brake	m_{Mot}	kg	23

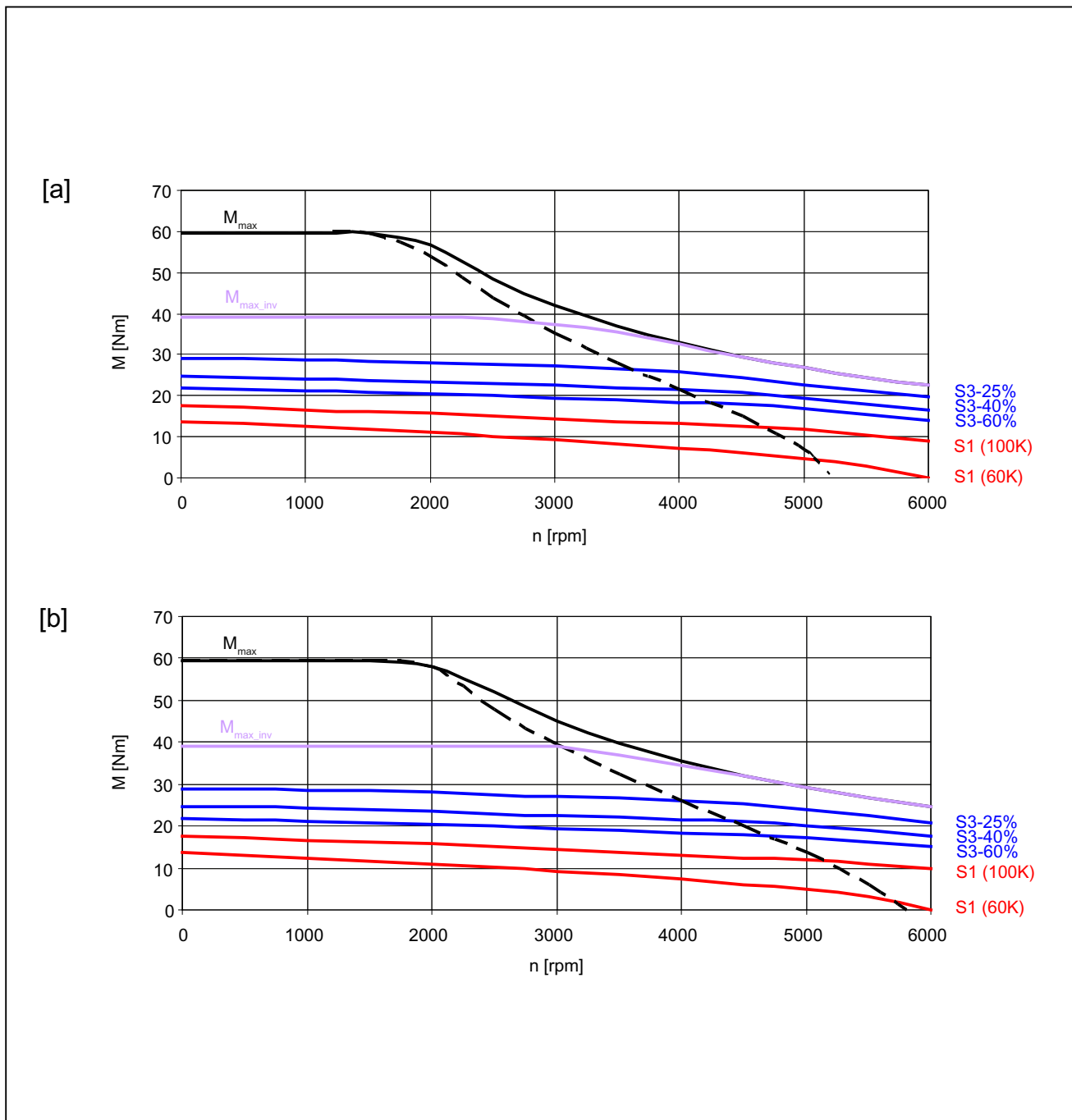

[a] SIMODRIVE 611 (UE) 400 V

[b] SIMODRIVE 611 (E/R) 400 V

The characteristic curves are only valid for optimized inverter setting data

Figure 4-75 1FT7067-7SF7

4.2 Torque-speed characteristic

Table 4- 72 1FT7067-7SH7

Technical data	Code	Unit	Value
Configuration data			
Rated speed	n_N	rpm	4500
Number of poles	2p	---	6
Rated torque (100 K)	$M_N (100 K)$	Nm	13
Rated current (100 K)	$I_N (100 K)$	A	15
Static torque (60 K)	$M_0 (60 K)$	Nm	13
Static torque (100 K)	$M_0 (100 K)$	Nm	17
Stall current (60 K)	$I_0 (60 K)$	A	14.5
Stall current (100 K)	$I_0 (100 K)$	A	19
Moment of inertia (with brake)	J_{MotBr}	10^{-4} kgm^2	10.9
Moment of inertia (without brake)	J_{Mot}	10^{-4} kgm^2	8.3
Optimum operating point			
Optimum speed	n_{opt}	rpm	4500
Optimum power	P_{opt}	kW	6.1
Limiting data			
Max. permissible speed (mech.)	$n_{max \text{ mech}}$	rpm	9000
Max. permissible speed (inverter)	$n_{max \text{ Inv}}$	rpm	9000
Maximum torque	M_{max}	Nm	60
Maximum current	I_{max}	A	80
Physical constants			
Torque constant	k_T	Nm/A	0.89
Voltage constant	k_E	V/1000 rpm	57
Winding resistance at 20 °C	R_{Str}	Ω	0.18
Rotating field inductance	L_D	mH	3.5
Electrical time constant	T_{el}	ms	19
Mechanical time constant	T_{mech}	ms	0.6
Thermal time constant	T_{th}	min	20
Shaft torsional stiffness	C_t	Nm/rad	21600
Weight with brake	m_{MotBr}	kg	24
Weight without brake	m_{Mot}	kg	23

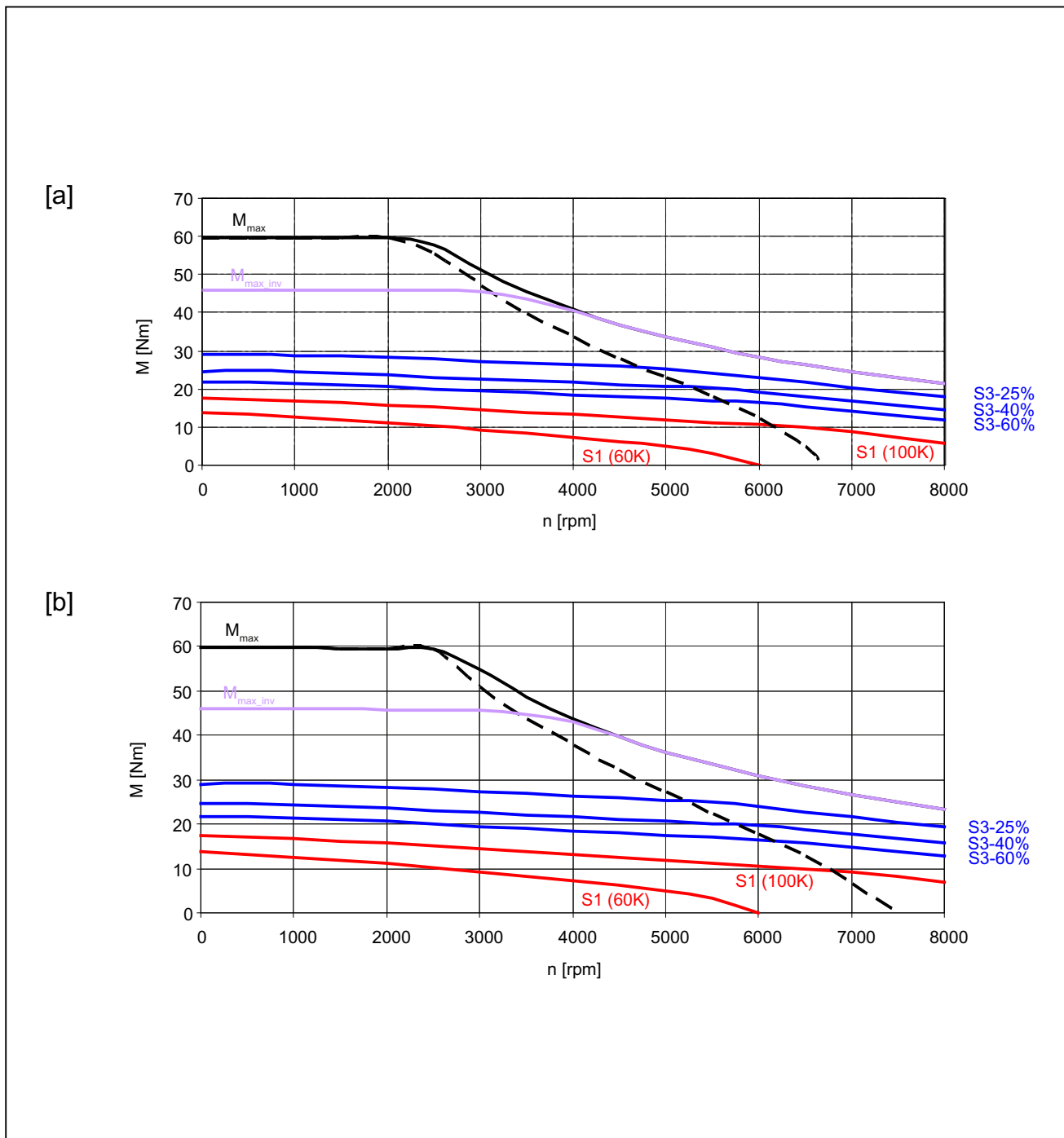

[a] SIMODRIVE 611 (UE) 400 V

[b] SIMODRIVE 611 (E/R) 400 V

The characteristic curves are only valid for optimized inverter setting data

Figure 4-76 1FT7067-7SH7

4.2 Torque-speed characteristic

Table 4- 73 1FT7085-7SF7

Technical data	Code	Unit	Value
Configuration data			
Rated speed	n_N	rpm	3000
Number of poles	$2p$	---	8
Rated torque (100 K)	$M_N (100 K)$	Nm	23
Rated current (100 K)	$I_N (100 K)$	A	20
Static torque (60 K)	$M_0 (60 K)$	Nm	26
Static torque (100 K)	$M_0 (100 K)$	Nm	34
Stall current (60 K)	$I_0 (60 K)$	A	22
Stall current (100 K)	$I_0 (100 K)$	A	28
Moment of inertia (with brake)	J_{MotBr}	10^{-4} kgm ²	34.9
Moment of inertia (without brake)	J_{Mot}	10^{-4} kgm ²	20.7
Optimum operating point			
Optimum speed	n_{opt}	rpm	3000
Optimum power	P_{opt}	kW	7.2
Limiting data			
Max. permissible speed (mech.)	$n_{max mech}$	rpm	8000
Max. permissible speed (inverter)	$n_{max Inv}$	rpm	7500
Maximum torque	M_{max}	Nm	105
Maximum current	I_{max}	A	126
Physical constants			
Torque constant	k_T	Nm/A	1.20
Voltage constant	k_E	V/1000 rpm	77
Winding resistance at 20 °C	R_{Str}	Ω	0.12
Rotating field inductance	L_D	mH	3.1
Electrical time constant	T_{el}	ms	26
Mechanical time constant	T_{mech}	ms	0.5
Thermal time constant	T_{th}	min	24
Shaft torsional stiffness	C_t	Nm/rad	51100
Weight with brake	m_{MotBr}	kg	37
Weight without brake	m_{Mot}	kg	34

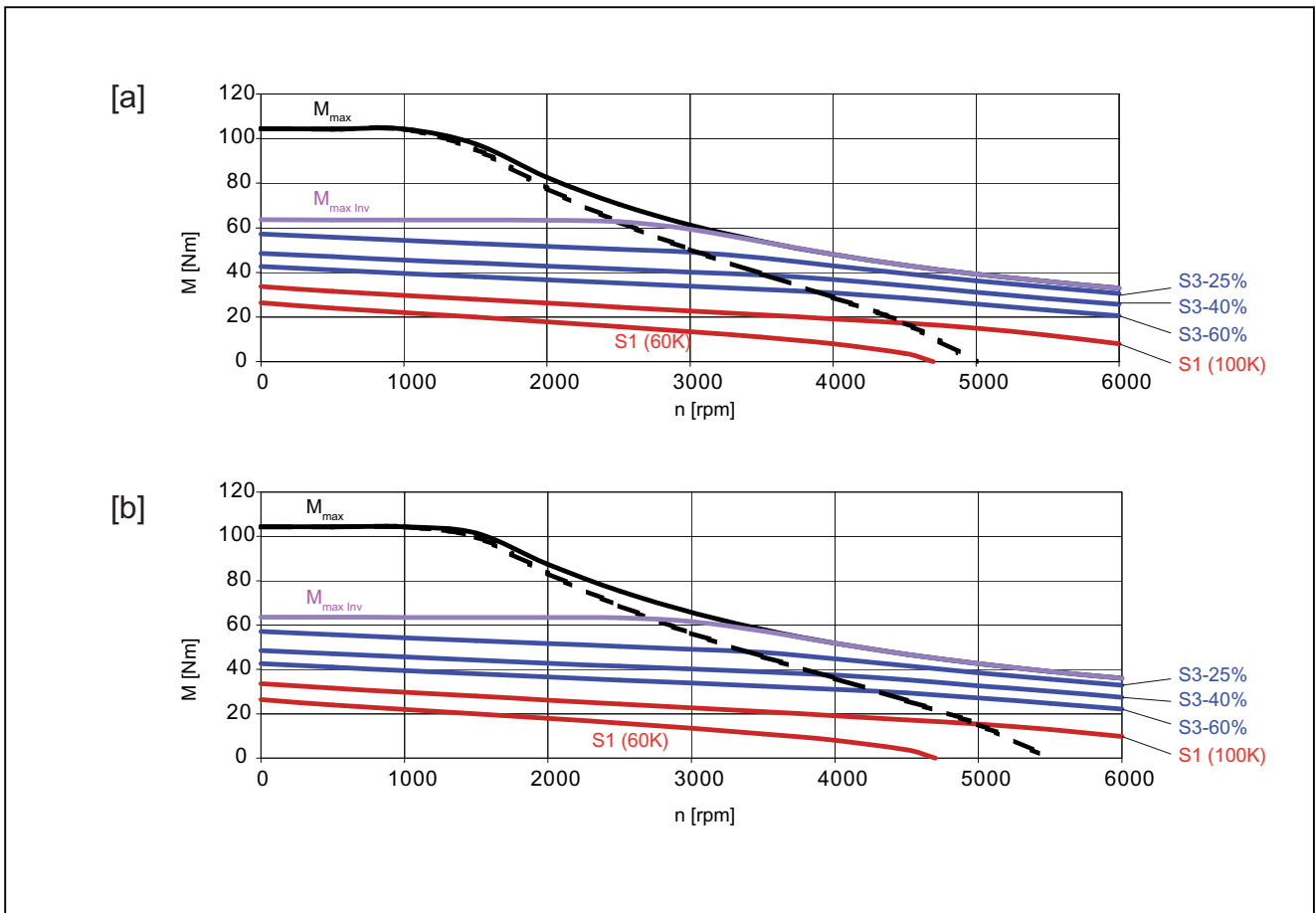

[a] SIMODRIVE 611 (UE) 400 V

[b] SIMODRIVE 611 (E/R) 400 V

The characteristic curves are only valid for optimized inverter setting data

Figure 4-77 1FT7085-7SF7

Table 4- 74 1FT7085-7SH7

Technical data	Code	Unit	Value
Configuration data			
Rated speed	n_N	rpm	4500
Number of poles	$2p$	---	8
Rated torque (100 K)	$M_N (100 K)$	Nm	17.5
Rated current (100 K)	$I_N (100 K)$	A	22.5
Static torque (60 K)	$M_0 (60 K)$	Nm	26
Static torque (100 K)	$M_0 (100 K)$	Nm	34
Stall current (60 K)	$I_0 (60 K)$	A	30
Stall current (100 K)	$I_0 (100 K)$	A	40
Moment of inertia (with brake)	J_{MotBr}	10^{-4} kgm ²	34.9
Moment of inertia (without brake)	J_{Mot}	10^{-4} kgm ²	20.7

Technical data and characteristics

4.2 Torque-speed characteristic

Technical data	Code	Unit	Value
Optimum operating point			
Optimum speed	n_{opt}	rpm	4500
Optimum power	P_{opt}	kW	8.2
Limiting data			
Max. permissible speed (mech.)	$n_{max\ mech}$	rpm	8000
Max. permissible speed (inverter)	$n_{max\ Inv}$	rpm	8000
Maximum torque	M_{max}	Nm	105
Maximum current	I_{max}	A	178
Physical constants			
Torque constant	k_T	Nm/A	0.86
Voltage constant	k_E	V/1000 rpm	55
Winding resistance at 20 °C	R_{Str}	Ω	0.06
Rotating field inductance	L_D	mH	1.6
Electrical time constant	T_{el}	ms	27
Mechanical time constant	T_{mech}	ms	0.5
Thermal time constant	T_{th}	min	24
Shaft torsional stiffness	C_t	Nm/rad	51100
Weight with brake	m_{MotBr}	kg	37
Weight without brake	m_{Mot}	kg	34

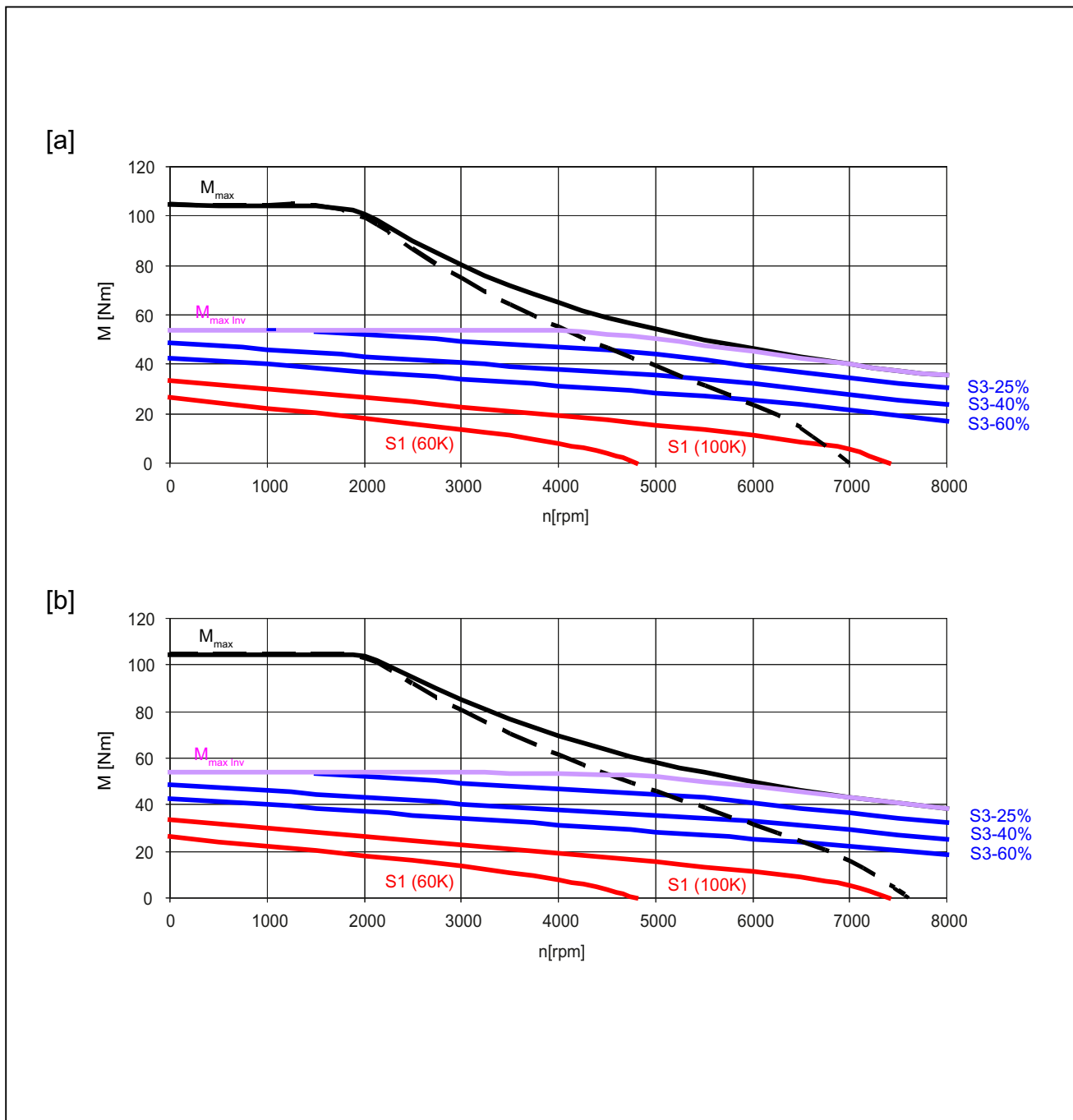

[a] SIMODRIVE 611 (UE) 400 V

[b] SIMODRIVE 611 (E/R) 400 V

The characteristic curves are only valid for optimized inverter setting data

Figure 4-78 1FT7085-7SH7

4.2 Torque-speed characteristic

Table 4- 75 1FT7087-7SF7

Technical data	Code	Unit	Value
Configuration data			
Rated speed	n_N	rpm	3000
Number of poles	$2p$	---	8
Rated torque (100 K)	$M_N (100 K)$	Nm	33
Rated current (100 K)	$I_N (100 K)$	A	29
Static torque (60 K)	$M_0 (60 K)$	Nm	37
Static torque (100 K)	$M_0 (100 K)$	Nm	48
Stall current (60 K)	$I_0 (60 K)$	A	31
Stall current (100 K)	$I_0 (100 K)$	A	40
Moment of inertia (with brake)	J_{MotBr}	10^{-4} kgm ²	41.6
Moment of inertia (without brake)	J_{Mot}	10^{-4} kgm ²	27.4
Optimum operating point			
Optimum speed	n_{opt}	rpm	3000
Optimum power	P_{opt}	kW	10.4
Limiting data			
Max. permissible speed (mech.)	$n_{max mech}$	rpm	8000
Max. permissible speed (inverter)	$n_{max Inv}$	rpm	7500
Maximum torque	M_{max}	Nm	150
Maximum current	I_{max}	A	170
Physical constants			
Torque constant	k_T	Nm/A	1.20
Voltage constant	k_E	V/1000 rpm	77
Winding resistance at 20 °C	R_{Str}	Ω	0.08
Rotating field inductance	L_D	mH	2.1
Electrical time constant	T_{el}	ms	26
Mechanical time constant	T_{mech}	ms	0.5
Thermal time constant	T_{th}	min	25
Shaft torsional stiffness	C_t	Nm/rad	45300
Weight with brake	m_{MotBr}	kg	45
Weight without brake	m_{Mot}	kg	42

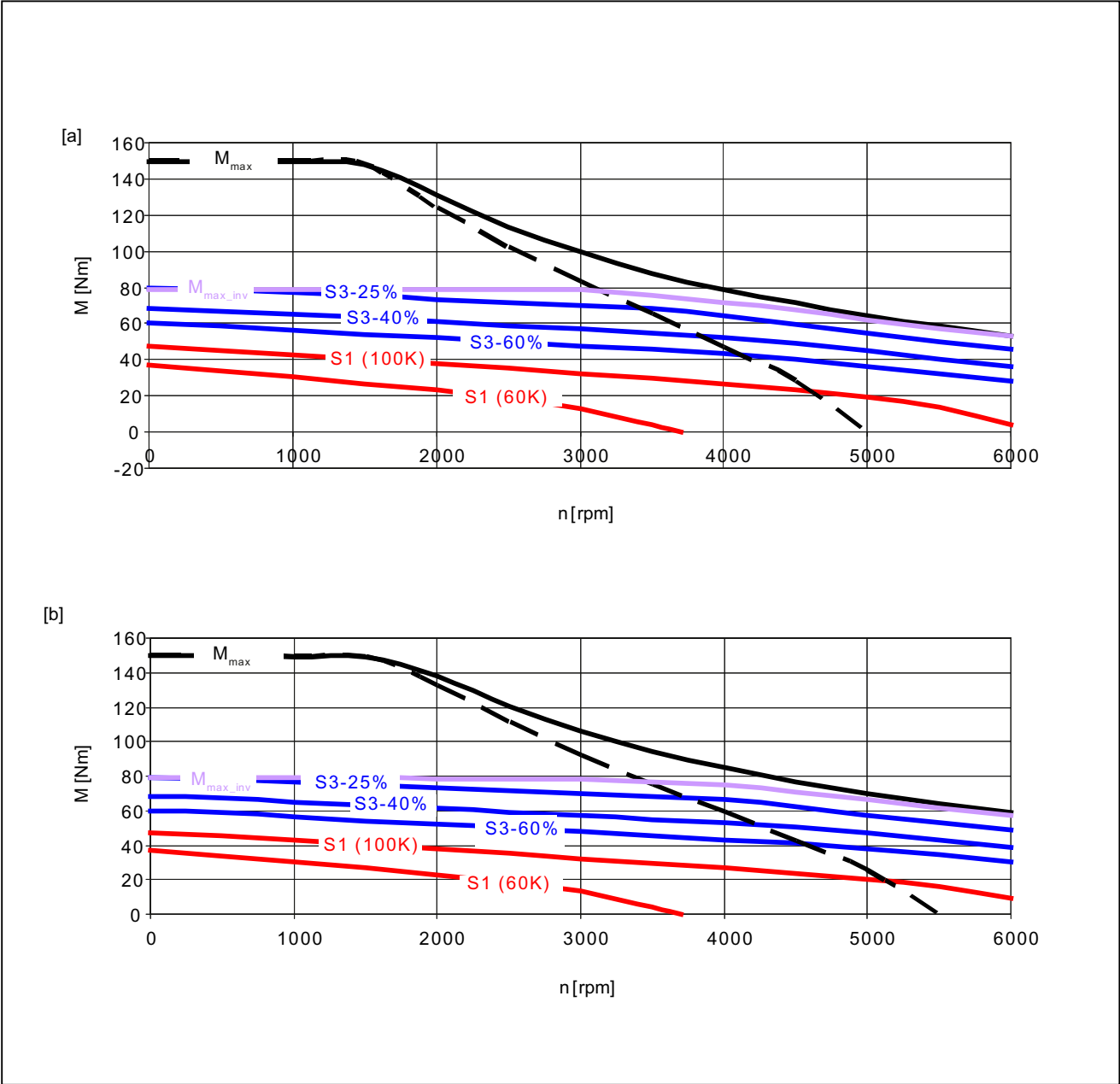

[a] SIMODRIVE 611 (UE) 400 V

[b] SIMODRIVE 611 (E/R) 400 V

The characteristic curves are only valid for optimized inverter setting data

Figure 4-79 1FT7087-7SF7

4.2 Torque-speed characteristic

Table 4- 76 1FT7087-7SH7

Technical data	Code	Unit	Value
Configuration data			
Rated speed	n_N	rpm	4500
Number of poles	2p	---	8
Rated torque (100 K)	$M_N (100\text{ K})$	Nm	23
Rated current (100 K)	$I_N (100\text{ K})$	A	24
Static torque (60 K)	$M_0 (60\text{ K})$	Nm	37
Static torque (100 K)	$M_0 (100\text{ K})$	Nm	48
Stall current (60 K)	$I_0 (60\text{ K})$	A	35
Stall current (100 K)	$I_0 (100\text{ K})$	A	45
Moment of inertia (with brake)	J_{MotBr}	10^{-4} kgm^2	41.6
Moment of inertia (without brake)	J_{Mot}	10^{-4} kgm^2	27.4
Optimum operating point			
Optimum speed	n_{opt}	rpm	4500
Optimum power	P_{opt}	kW	10.8
Limiting data			
Max. permissible speed (mech.)	$n_{max\ mech}$	rpm	8000
Max. permissible speed (inverter)	$n_{max\ Inv}$	rpm	8000
Maximum torque	M_{max}	Nm	150
Maximum current	I_{max}	A	195
Physical constants			
Torque constant	k_T	Nm/A	1.06
Voltage constant	k_E	V/1000 rpm	68
Winding resistance at 20 °C	R_{Str}	Ω	0.06
Rotating field inductance	L_D	mH	1.7
Electrical time constant	T_{el}	ms	28
Mechanical time constant	T_{mech}	ms	0.4
Thermal time constant	T_{th}	min	25
Shaft torsional stiffness	c_t	Nm/rad	45300
Weight with brake	m_{MotBr}	kg	46
Weight without brake	m_{Mot}	kg	43

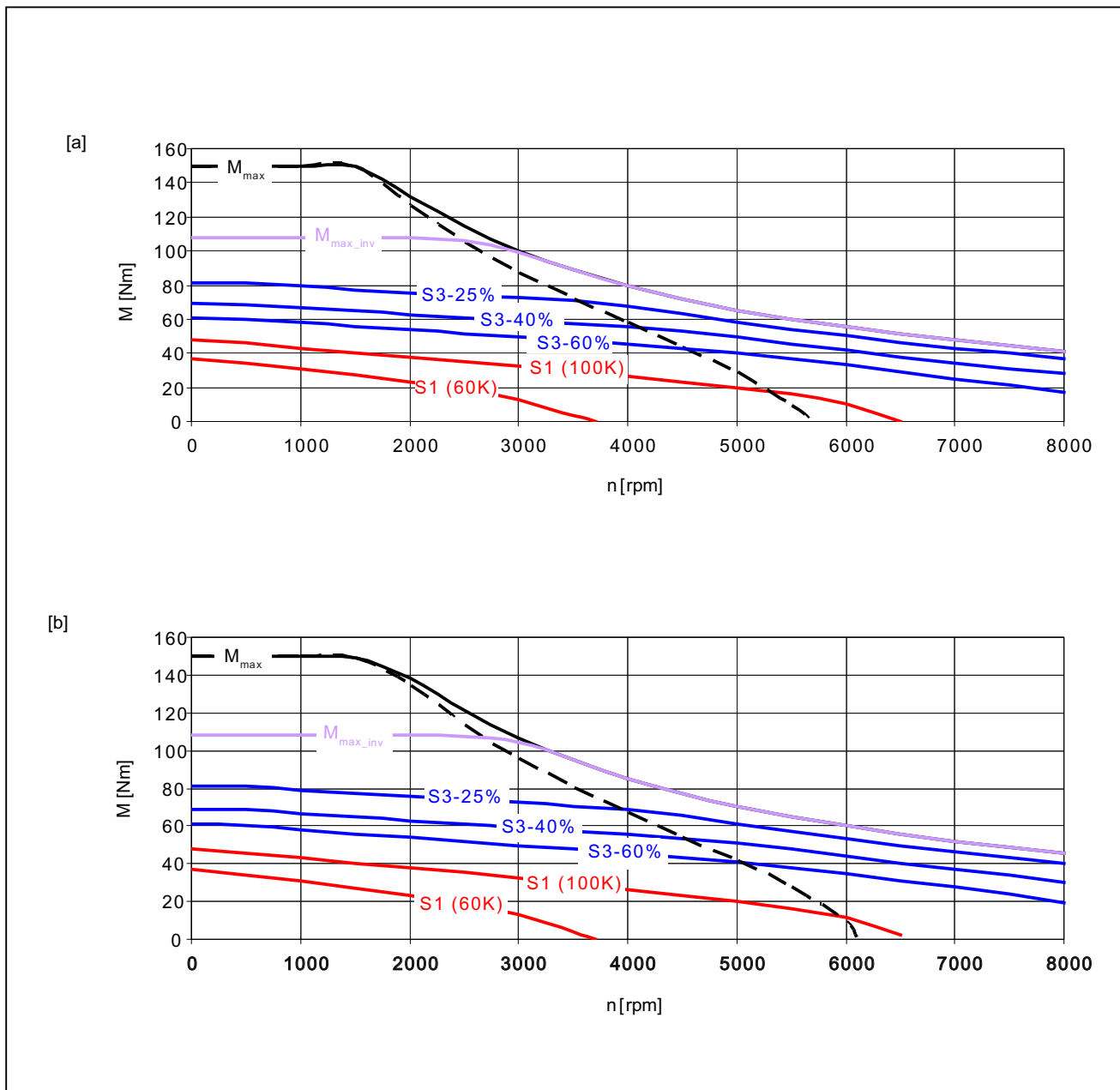

[a] SIMODRIVE 611 (UE) 400 V

[b] SIMODRIVE 611 (E/R) 400 V

The characteristic curves are only valid for optimized inverter setting data

Figure 4-80 1FT7087-7SH7

4.2 Torque-speed characteristic

4.2.5 1FT7 High Dynamic synchronous motors, liquid cooling

Table 4- 77 1FT7065-7WF7

Technical data	Code	Unit	Value
Configuration data			
Rated speed	n_N	rpm	3000
Number of poles	$2p$	---	6
Rated torque (100 K)	$M_N (100\text{ K})$	Nm	18
Rated current (100 K)	$I_N (100\text{ K})$	A	15
Static torque (60 K)	$M_0 (60\text{ K})$	Nm	16
Static torque (100 K)	$M_0 (100\text{ K})$	Nm	19
Stall current (60 K)	$I_0 (60\text{ K})$	A	14
Stall current (100 K)	$I_0 (100\text{ K})$	A	16
Moment of inertia (with brake)	J_{MotBr}	10^{-4} kgm^2	9
Moment of inertia (without brake)	J_{Mot}	10^{-4} kgm^2	6.4
Optimum operating point			
Optimum speed	n_{opt}	rpm	3000
Optimum power	P_{opt}	kW	5.7
Limiting data			
Max. permissible speed (mech.)	$n_{max\ mech}$	rpm	9000
Max. permissible speed (inverter)	$n_{max\ Inv}$	rpm	7700
Maximum torque	M_{max}	Nm	45
Maximum current	I_{max}	A	49
Physical constants			
Torque constant	k_T	Nm/A	1.17
Voltage constant	k_E	V/1000 rpm	75
Winding resistance at 20 °C	R_{Str}	Ω	0.43
Rotating field inductance	L_D	mH	8.2
Electrical time constant	T_{el}	ms	19
Mechanical time constant	T_{mech}	ms	0.6
Thermal time constant	T_{th}	min	9
Shaft torsional stiffness	C_t	Nm/rad	23700
Weight with brake	m_{MotBr}	kg	17
Weight without brake	m_{Mot}	kg	16

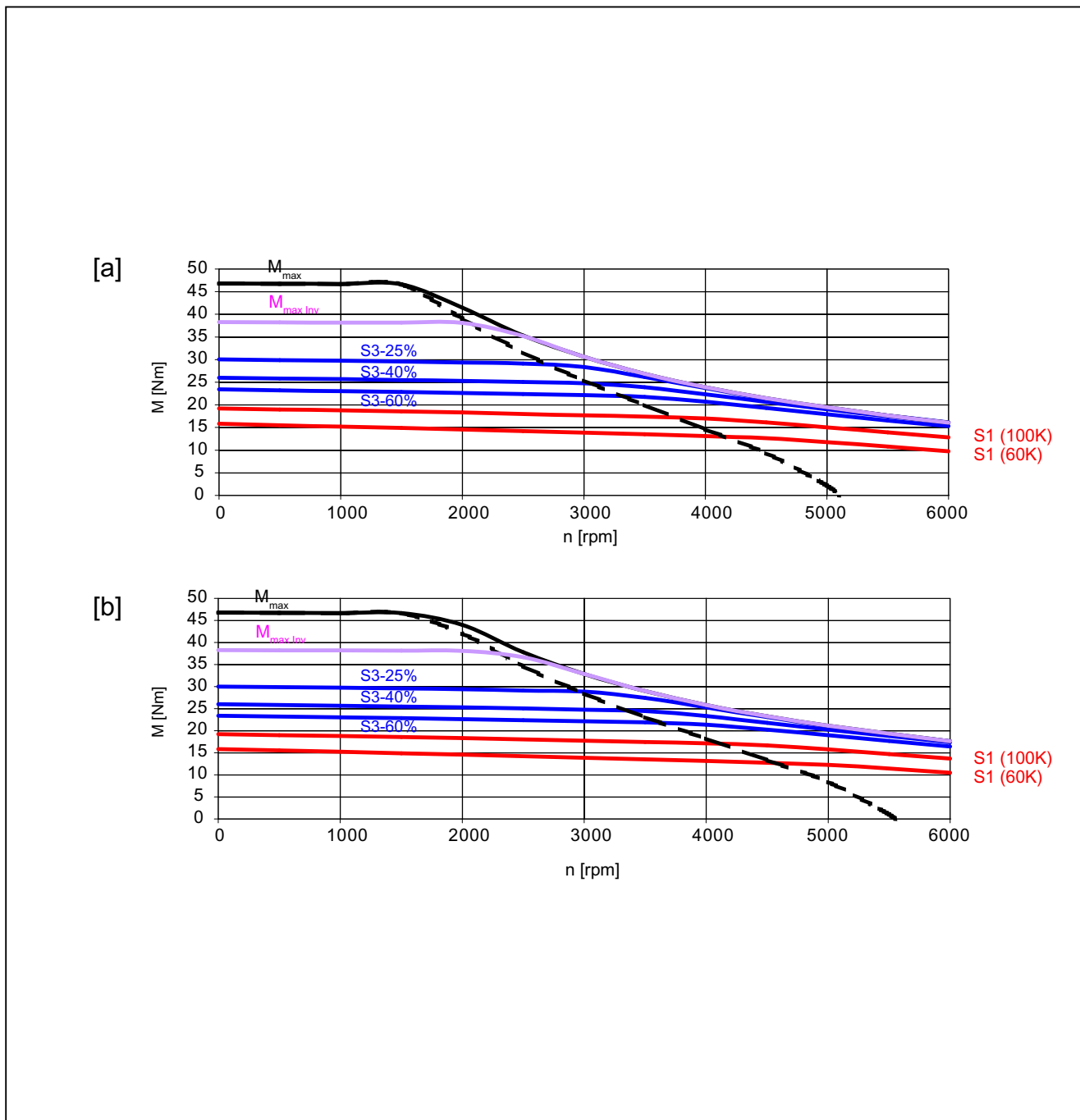

[a] SIMODRIVE 611 (UE) 400 V

[b] SIMODRIVE 611 (E/R) 400 V

The characteristic curves are only valid for optimized inverter setting data

Figure 4-81 1FT7065-7WF7

4.2 Torque-speed characteristic

Table 4- 78 1FT7065-7WH7

Technical data	Code	Unit	Value
Configuration data			
Rated speed	n_N	rpm	4500
Number of poles	2p	---	6
Rated torque (100 K)	$M_N (100\text{ K})$	Nm	16.5
Rated current (100 K)	$I_N (100\text{ K})$	A	20
Static torque (60 K)	$M_0 (60\text{ K})$	Nm	16
Static torque (100 K)	$M_0 (100\text{ K})$	Nm	19
Stall current (60 K)	$I_0 (60\text{ K})$	A	18.5
Stall current (100 K)	$I_0 (100\text{ K})$	A	22
Moment of inertia (with brake)	J_{MotBr}	10^{-4} kgm^2	9
Moment of inertia (without brake)	J_{Mot}	10^{-4} kgm^2	6.4
Optimum operating point			
Optimum speed	n_{opt}	rpm	4500
Optimum power	P_{opt}	kW	7.8
Limiting data			
Max. permissible speed (mech.)	$n_{max\ mech}$	rpm	9000
Max. permissible speed (inverter)	$n_{max\ Inv}$	rpm	9000
Maximum torque	M_{max}	Nm	45
Maximum current	I_{max}	A	67
Physical constants			
Torque constant	k_T	Nm/A	0.86
Voltage constant	k_E	V/1000 rpm	55
Winding resistance at 20 °C	R_{Str}	Ω	0.23
Rotating field inductance	L_D	mH	4.4
Electrical time constant	T_{el}	ms	19
Mechanical time constant	T_{mech}	ms	0.6
Thermal time constant	T_{th}	min	9
Shaft torsional stiffness	C_t	Nm/rad	23700
Weight with brake	m_{MotBr}	kg	17
Weight without brake	m_{Mot}	kg	16

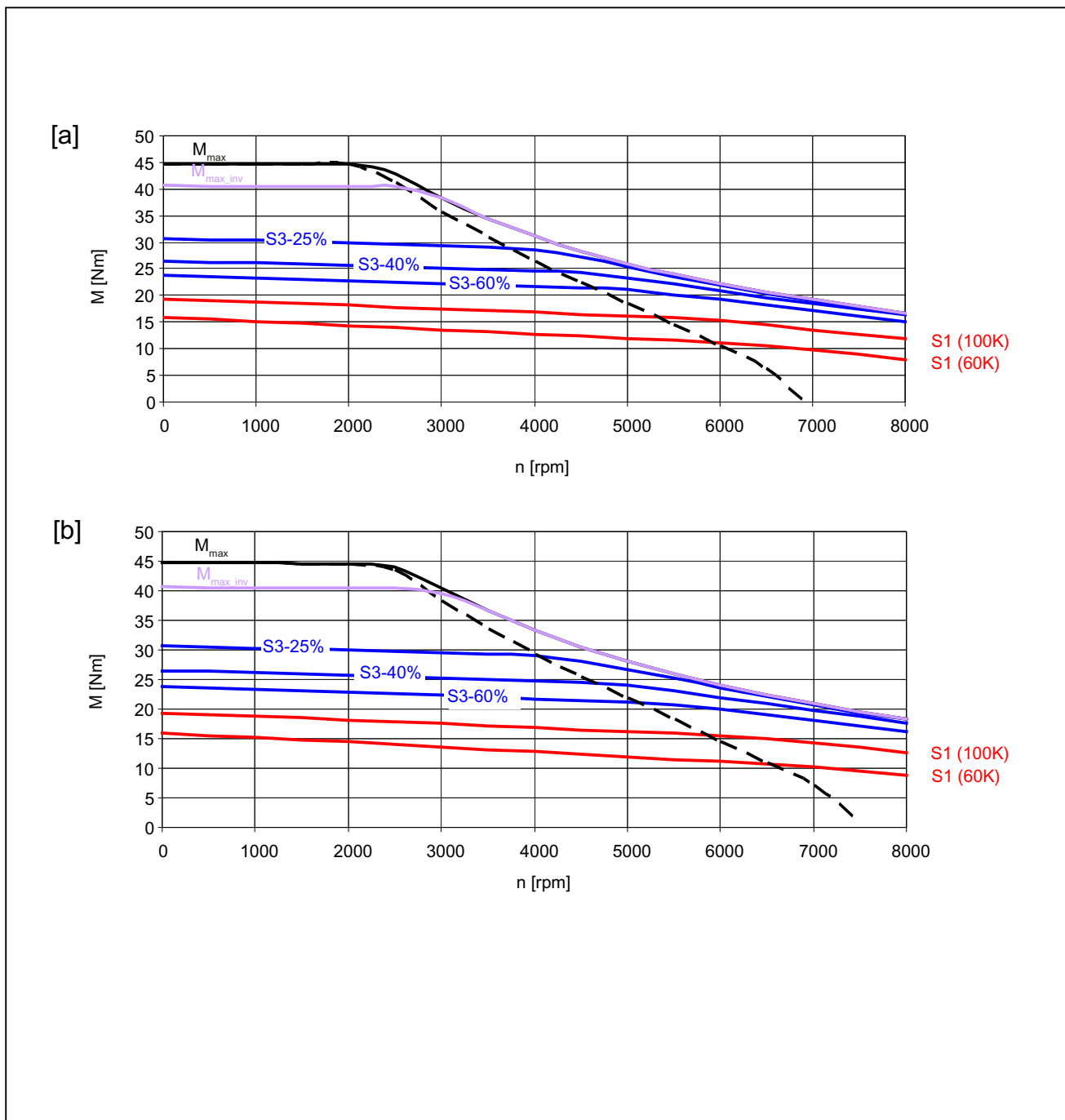

[a] SIMODRIVE 611 (UE) 400 V

[b] SIMODRIVE 611 (E/R) 400 V

The characteristic curves are only valid for optimized inverter setting data

Figure 4-82 1FT7065-7WH7

4.2 Torque-speed characteristic

Table 4- 79 1FT7067-7WF7

Technical data	Code	Unit	Value
Configuration data			
Rated speed	n_N	rpm	3000
Number of poles	$2p$	---	6
Rated torque (100 K)	$M_N (100\text{ K})$	Nm	23.5
Rated current (100 K)	$I_N (100\text{ K})$	A	21
Static torque (60 K)	$M_0 (60\text{ K})$	Nm	20
Static torque (100 K)	$M_0 (100\text{ K})$	Nm	25
Stall current (60 K)	$I_0 (60\text{ K})$	A	17.5
Stall current (100 K)	$I_0 (100\text{ K})$	A	22
Moment of inertia (with brake)	J_{MotBr}	10^{-4} kgm ²	10.9
Moment of inertia (without brake)	J_{Mot}	10^{-4} kgm ²	8.3
Optimum operating point			
Optimum speed	n_{opt}	rpm	3000
Optimum power	P_{opt}	kW	7.4
Limiting data			
Max. permissible speed (mech.)	$n_{max\ mech}$	rpm	9000
Max. permissible speed (inverter)	$n_{max\ Inv}$	rpm	7900
Maximum torque	M_{max}	Nm	60
Maximum current	I_{max}	A	63
Physical constants			
Torque constant	k_T	Nm/A	1.14
Voltage constant	k_E	V/1000 rpm	73
Winding resistance at 20 °C	R_{Str}	Ω	0.3
Rotating field inductance	L_D	mH	5.7
Electrical time constant	T_{el}	ms	19
Mechanical time constant	T_{mech}	ms	0.6
Thermal time constant	T_{th}	min	11
Shaft torsional stiffness	C_t	Nm/rad	21600
Weight with brake	m_{MotBr}	kg	23
Weight without brake	m_{Mot}	kg	22

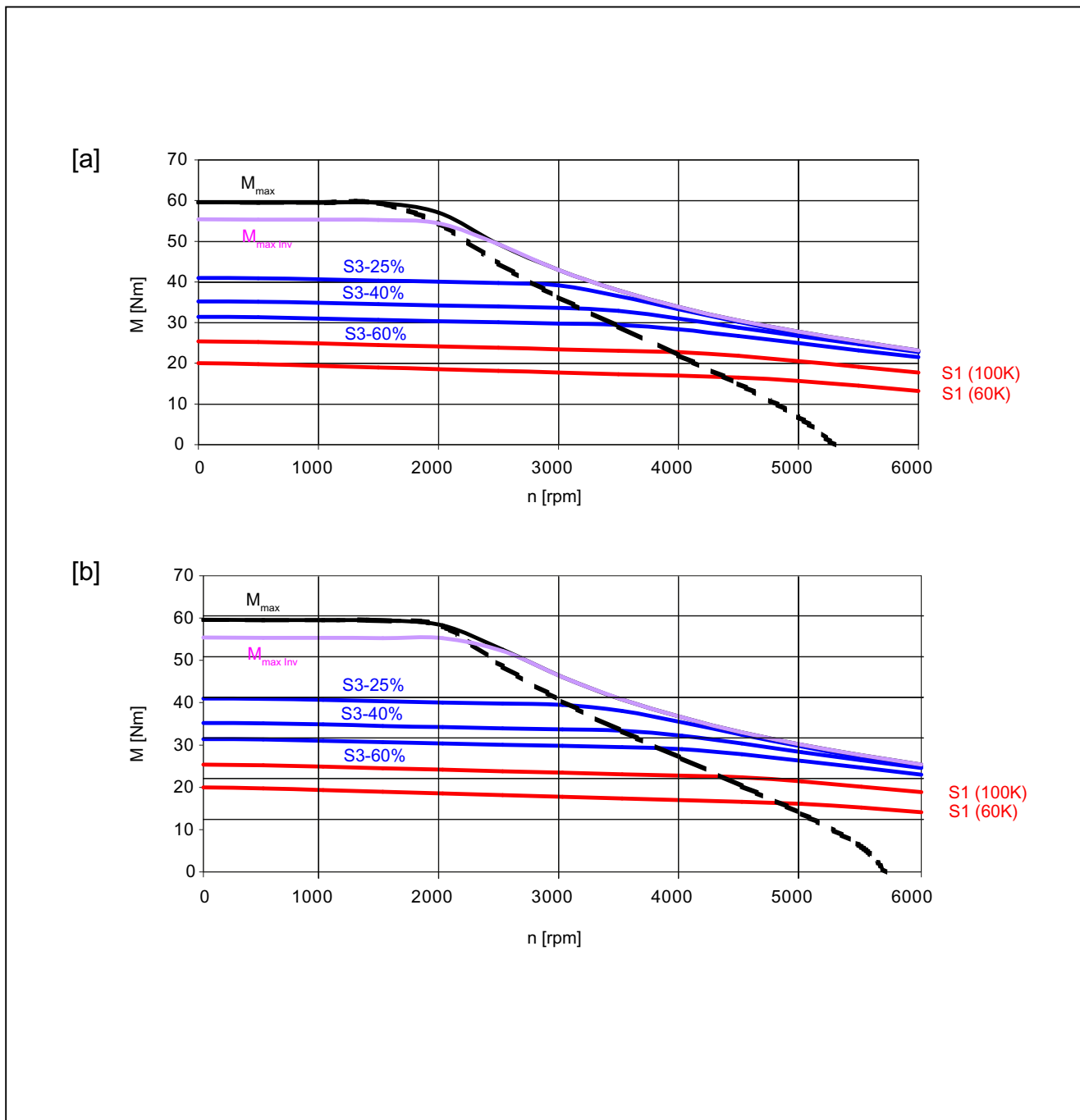

[a] SIMODRIVE 611 (UE) 400 V

[b] SIMODRIVE 611 (E/R) 400 V

The characteristic curves are only valid for optimized inverter setting data

Figure 4-83 1FT7067-7WF7

4.2 Torque-speed characteristic

Table 4- 80 1FT7067-7WH7

Technical data	Code	Unit	Value
Configuration data			
Rated speed	n_N	rpm	4500
Number of poles	2p	---	6
Rated torque (100 K)	$M_N (100 K)$	Nm	22
Rated current (100 K)	$I_N (100 K)$	A	25
Static torque (60 K)	$M_0 (60 K)$	Nm	20
Static torque (100 K)	$M_0 (100 K)$	Nm	25
Stall current (60 K)	$I_0 (60 K)$	A	20
Stall current (100 K)	$I_0 (100 K)$	A	28
Moment of inertia (with brake)	J_{MotBr}	10^{-4} kgm ²	10.9
Moment of inertia (without brake)	J_{Mot}	10^{-4} kgm ²	8.3
Optimum operating point			
Optimum speed	n_{opt}	rpm	4500
Optimum power	P_{opt}	kW	10.4
Limiting data			
Max. permissible speed (mech.)	$n_{max mech}$	rpm	9000
Max. permissible speed (inverter)	$n_{max Inv}$	rpm	9000
Maximum torque	M_{max}	Nm	60
Maximum current	I_{max}	A	80
Physical constants			
Torque constant	k_T	Nm/A	0.89
Voltage constant	k_E	V/1000 rpm	57
Winding resistance at 20 °C	R_{Str}	Ω	0.18
Rotating field inductance	L_D	mH	3.5
Electrical time constant	T_{el}	ms	19
Mechanical time constant	T_{mech}	ms	0.6
Thermal time constant	T_{th}	min	11
Shaft torsional stiffness	C_t	Nm/rad	21600
Weight with brake	m_{MotBr}	kg	23
Weight without brake	m_{Mot}	kg	22

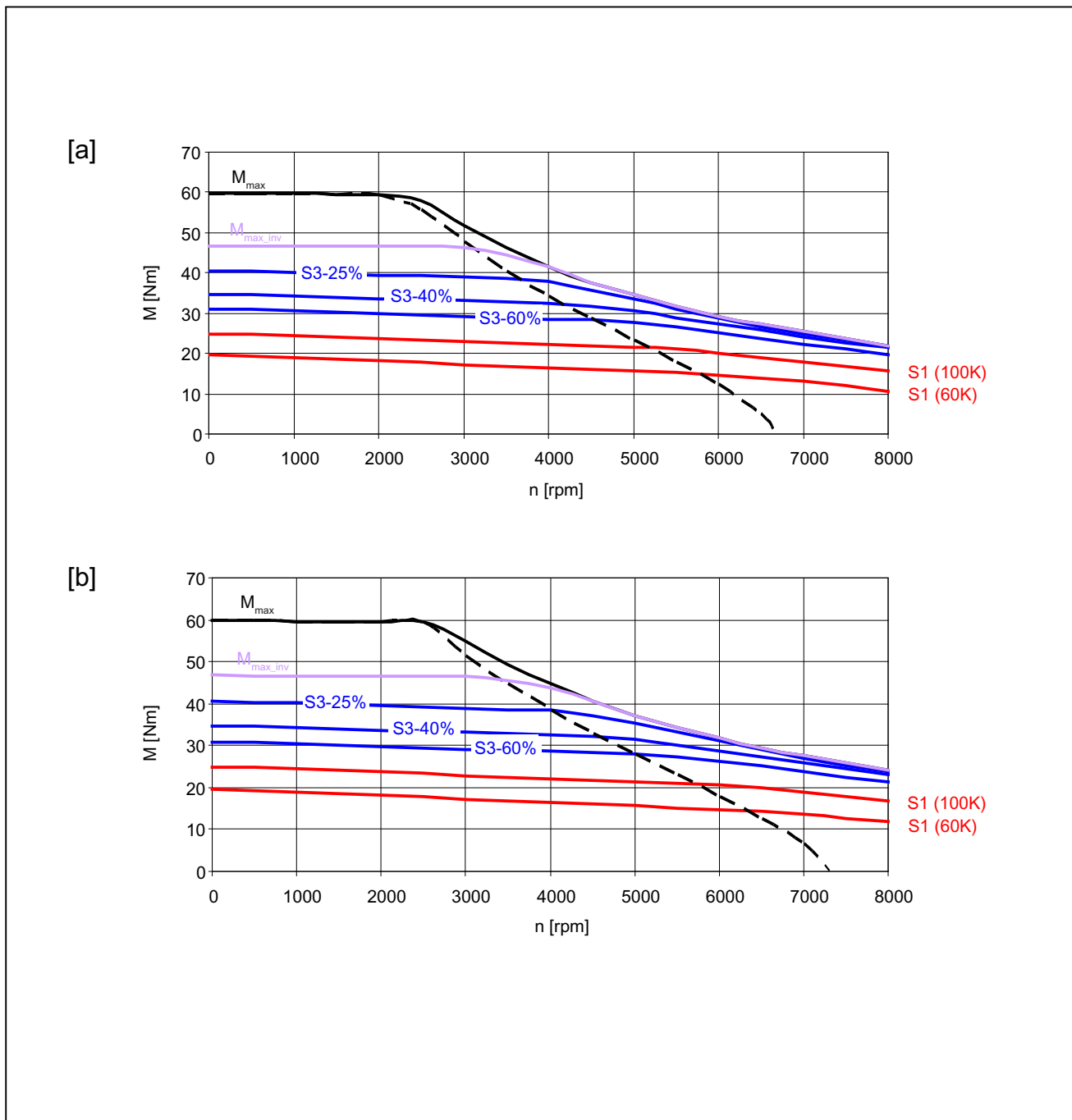

[a] SIMODRIVE 611 (UE) 400 V

[b] SIMODRIVE 611 (E/R) 400 V

The characteristic curves are only valid for optimized inverter setting data

Figure 4-84 1FT7067-7WH7

4.2 Torque-speed characteristic

Table 4- 81 1FT7085-7WF7

Technical data	Code	Unit	Value
Configuration data			
Rated speed	n_N	rpm	3000
Number of poles	$2p$	---	8
Rated torque (100 K)	$M_N (100\text{ K})$	Nm	38
Rated current (100 K)	$I_N (100\text{ K})$	A	32
Static torque (60 K)	$M_0 (60\text{ K})$	Nm	34
Static torque (100 K)	$M_0 (100\text{ K})$	Nm	43
Stall current (60 K)	$I_0 (60\text{ K})$	A	28
Stall current (100 K)	$I_0 (100\text{ K})$	A	36
Moment of inertia (with brake)	J_{MotBr}	10^{-4} kgm ²	34.9
Moment of inertia (without brake)	J_{Mot}	10^{-4} kgm ²	20.7
Optimum operating point			
Optimum speed	n_{opt}	rpm	3000
Optimum power	P_{opt}	kW	11.9
Limiting data			
Max. permissible speed (mech.)	$n_{max\ mech}$	rpm	8000
Max. permissible speed (inverter)	$n_{max\ Inv}$	rpm	7500
Maximum torque	M_{max}	Nm	105
Maximum current	I_{max}	A	126
Physical constants			
Torque constant	k_T	Nm/A	1.20
Voltage constant	k_E	V/1000 rpm	77
Winding resistance at 20 °C	R_{Str}	Ω	0.12
Rotating field inductance	L_D	mH	3.1
Electrical time constant	T_{el}	ms	26
Mechanical time constant	T_{mech}	ms	0.5
Thermal time constant	T_{th}	min	10
Shaft torsional stiffness	C_t	Nm/rad	51100
Weight with brake	m_{MotBr}	kg	35
Weight without brake	m_{Mot}	kg	32

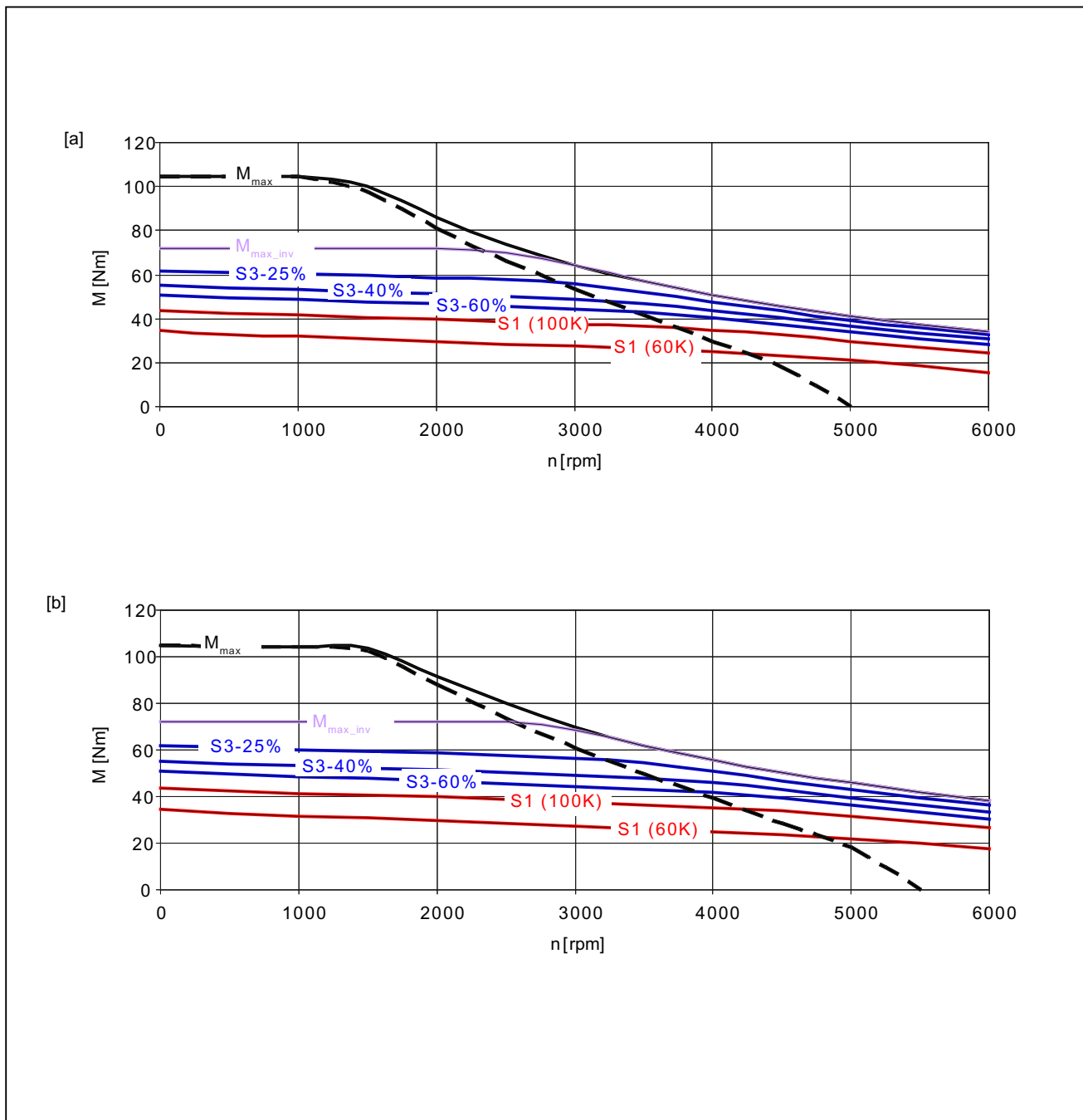

[a] SIMODRIVE 611 (UE) 400 V

[b] SIMODRIVE 611 (E/R) 400 V

The characteristic curves are only valid for optimized inverter setting data

Figure 4-85 1FT7085-7WF7

4.2 Torque-speed characteristic

Table 4- 82 1FT7085-7WH7

Technical data	Code	Unit	Value
Configuration data			
Rated speed	n_N	rpm	4500
Number of poles	2p	---	8
Rated torque (100 K)	$M_N (100\text{ K})$	Nm	33
Rated current (100 K)	$I_N (100\text{ K})$	A	48
Static torque (60 K)	$M_0 (60\text{ K})$	Nm	34
Static torque (100 K)	$M_0 (100\text{ K})$	Nm	43
Stall current (60 K)	$I_0 (60\text{ K})$	A	46
Stall current (100 K)	$I_0 (100\text{ K})$	A	58
Moment of inertia (with brake)	J_{MotBr}	10^{-4} kgm^2	34.9
Moment of inertia (without brake)	J_{Mot}	10^{-4} kgm^2	20.7
Optimum operating point			
Optimum speed	n_{opt}	rpm	4500
Optimum power	P_{opt}	kW	15.5
Limiting data			
Max. permissible speed (mech.)	$n_{max\ mech}$	rpm	8000
Max. permissible speed (inverter)	$n_{max\ Inv}$	rpm	8000
Maximum torque	M_{max}	Nm	105
Maximum current	I_{max}	A	205
Physical constants			
Torque constant	k_T	Nm/A	0.74
Voltage constant	k_E	V/1000 rpm	47.5
Winding resistance at 20 °C	R_{Str}	Ω	0.046
Rotating field inductance	L_D	mH	1.2
Electrical time constant	T_{el}	ms	26
Mechanical time constant	T_{mech}	ms	0.5
Thermal time constant	T_{th}	min	10
Shaft torsional stiffness	C_t	Nm/rad	51100
Weight with brake	m_{MotBr}	kg	35
Weight without brake	m_{Mot}	kg	32

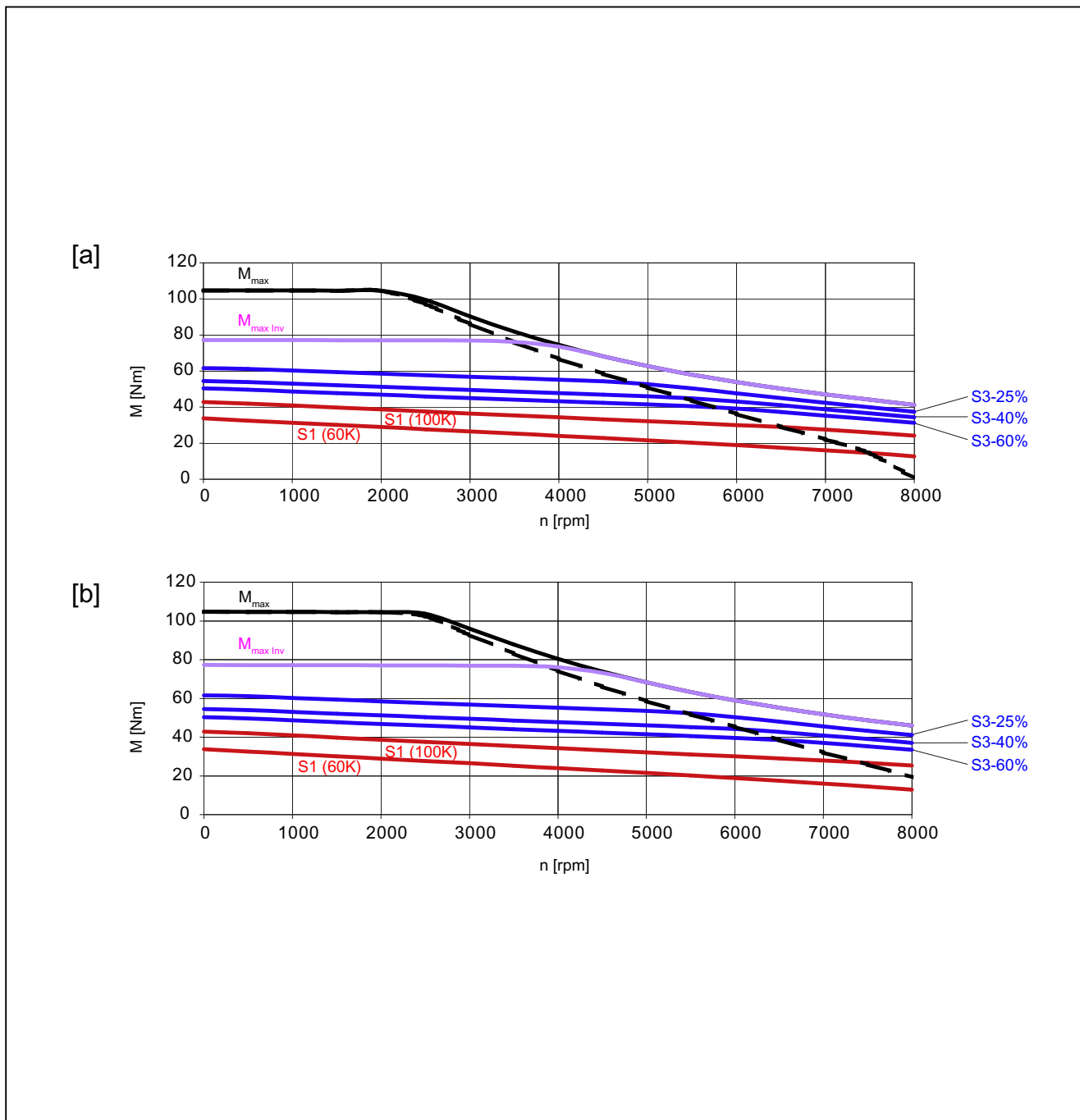

[a] SIMODRIVE 611 (UE) 400 V

[b] SIMODRIVE 611 (E/R) 400 V

The characteristic curves are only valid for optimized inverter setting data

Figure 4-86 1FT7085-7WH7

4.2 Torque-speed characteristic

Table 4- 83 1FT7087-7WF7

Technical data	Code	Unit	Value
Configuration data			
Rated speed	n_N	rpm	3000
Number of poles	$2p$	---	8
Rated torque (100 K)	$M_N (100\text{ K})$	Nm	51
Rated current (100 K)	$I_N (100\text{ K})$	A	43
Static torque (60 K)	$M_0 (60\text{ K})$	Nm	48
Static torque (100 K)	$M_0 (100\text{ K})$	Nm	61
Stall current (60 K)	$I_0 (60\text{ K})$	A	40
Stall current (100 K)	$I_0 (100\text{ K})$	A	51
Moment of inertia (with brake)	J_{MotBr}	10^{-4} kgm ²	41.6
Moment of inertia (without brake)	J_{Mot}	10^{-4} kgm ²	27.4
Optimum operating point			
Optimum speed	n_{opt}	rpm	3000
Optimum power	P_{opt}	kW	16.0
Limiting data			
Max. permissible speed (mech.)	$n_{max\ mech}$	rpm	8000
Max. permissible speed (inverter)	$n_{max\ Inv}$	rpm	7500
Maximum torque	M_{max}	Nm	150
Maximum current	I_{max}	A	170
Physical constants			
Torque constant	k_T	Nm/A	1.20
Voltage constant	k_E	V/1000 rpm	77
Winding resistance at 20 °C	R_{Str}	Ω	0.08
Rotating field inductance	L_D	mH	2.1
Electrical time constant	T_{el}	ms	26
Mechanical time constant	T_{mech}	ms	0.5
Thermal time constant	T_{th}	min	11
Shaft torsional stiffness	C_t	Nm/rad	45300
Weight with brake	m_{MotBr}	kg	44
Weight without brake	m_{Mot}	kg	41

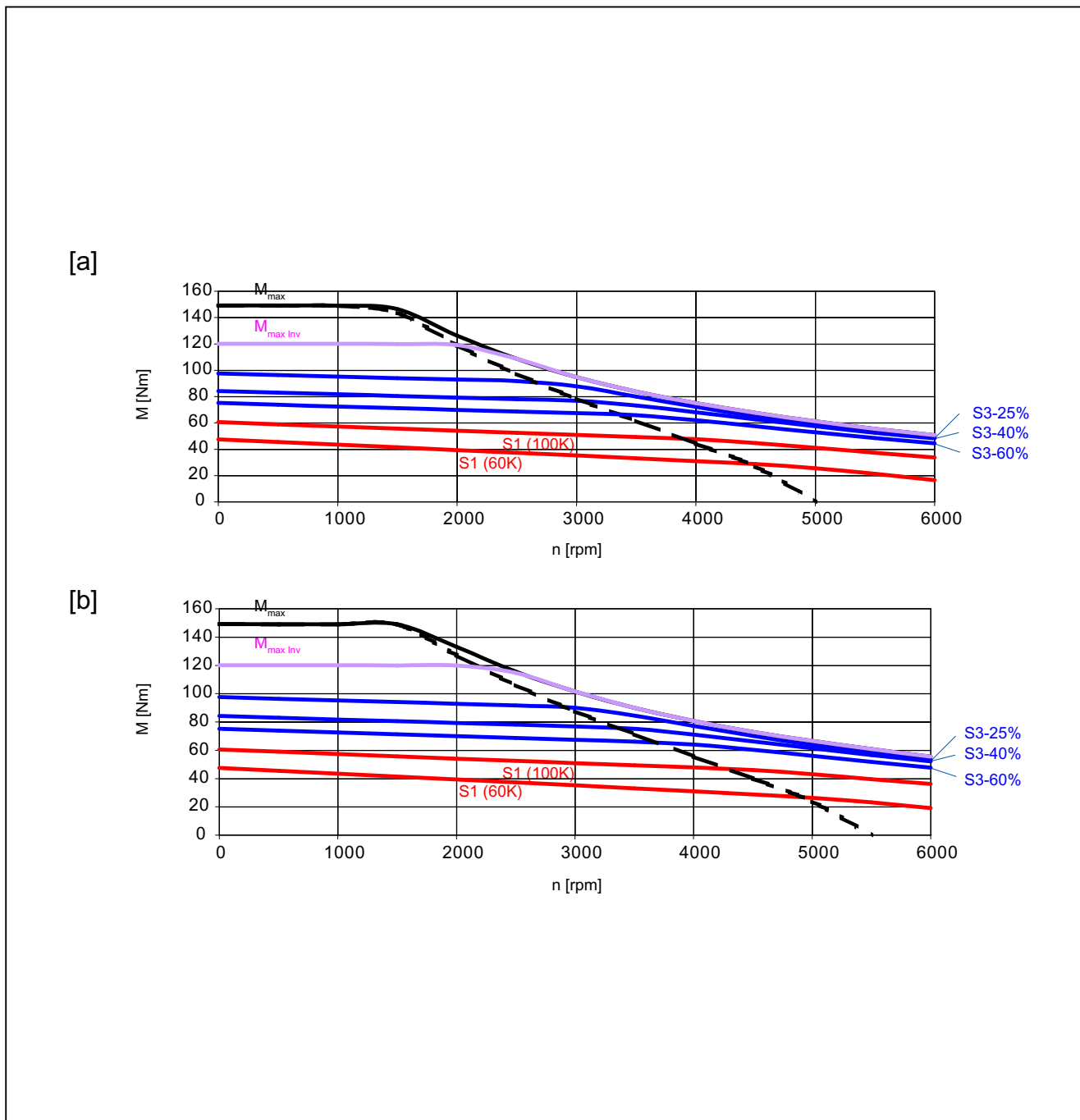

[a] SIMODRIVE 611 (UE) 400 V

[b] SIMODRIVE 611 (E/R) 400 V

The characteristic curves are only valid for optimized inverter setting data

Figure 4-87 1FT7087-7WF7

4.2 Torque-speed characteristic

Table 4- 84 1FT7087-7WH7

Technical data	Code	Unit	Value
Configuration data			
Rated speed	n_N	rpm	4500
Number of poles	2p	---	8
Rated torque (100 K)	$M_N (100\text{ K})$	Nm	46
Rated current (100 K)	$I_N (100\text{ K})$	A	53
Static torque (60 K)	$M_0 (60\text{ K})$	Nm	48
Static torque (100 K)	$M_0 (100\text{ K})$	Nm	61
Stall current (60 K)	$I_0 (60\text{ K})$	A	53
Stall current (100 K)	$I_0 (100\text{ K})$	A	67
Moment of inertia (with brake)	J_{MotBr}	10^{-4} kgm^2	41.6
Moment of inertia (without brake)	J_{Mot}	10^{-4} kgm^2	27.4
Optimum operating point			
Optimum speed	n_{opt}	rpm	4500
Optimum power	P_{opt}	kW	21.7
Limiting data			
Max. permissible speed (mech.)	$n_{max\ mech}$	rpm	8000
Max. permissible speed (inverter)	$n_{max\ Inv}$	rpm	8000
Maximum torque	M_{max}	Nm	150
Maximum current	I_{max}	A	225
Physical constants			
Torque constant	k_T	Nm/A	0.91
Voltage constant	k_E	V/1000 rpm	58
Winding resistance at 20 °C	R_{Str}	Ω	0.046
Rotating field inductance	L_D	mH	1.2
Electrical time constant	T_{el}	ms	26
Mechanical time constant	T_{mech}	ms	0.5
Thermal time constant	T_{th}	min	11
Shaft torsional stiffness	C_t	Nm/rad	45300
Weight with brake	m_{MotBr}	kg	44
Weight without brake	m_{Mot}	kg	41

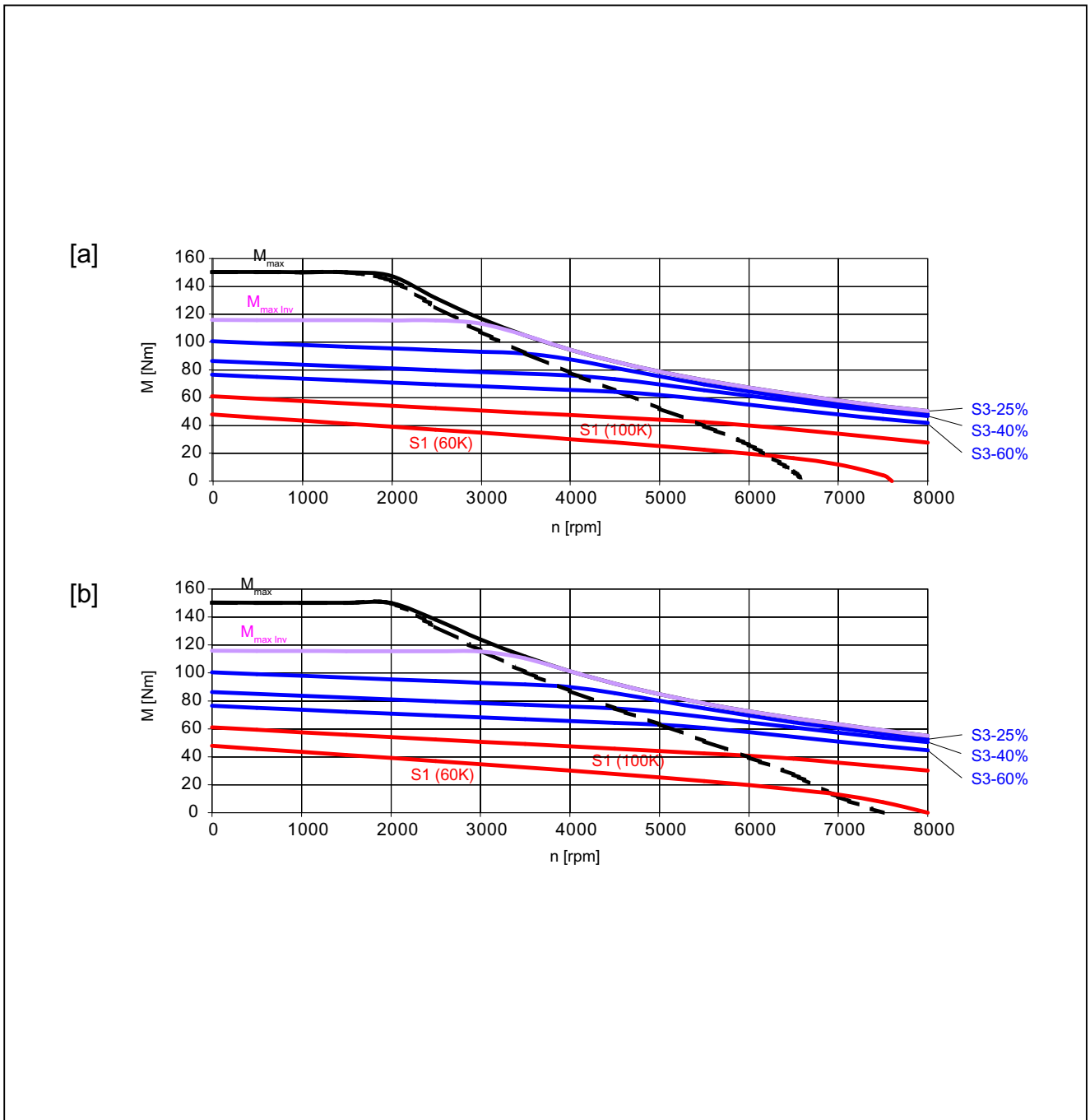

[a] SIMODRIVE 611 (UE) 400 V

[b] SIMODRIVE 611 (E/R) 400 V

The characteristic curves are only valid for optimized inverter setting data

Figure 4-88 1FT7087-7WH7

4.3 Dimension drawings

CAD CREATOR

Using a configuration interface that is very easy to understand, CAD CREATOR allows you to quickly find

- dimension drawings
- 2D/3D CAD data

and supports you when generating plant/system documentation regarding project-specific information.

In the online version the data for motors, drives and CNC controls are currently available to you. On the Intranet at <http://www.siemens.com/cad-creator>

Motors



- 1FK7, 1FT7, 1FT6, 1FE1 synchronous motors
- 1FW3 complete torque motors
- 1FK7, 1FK7 DYA, 1FT7, 1FT6 geared motors
- 1PH8 synchronous/induction motors
- 1PH7, 1PH4, 1PL6 induction motors
- 1PM4, 1PM6 induction motors
- 2SP1 spindle motors

SINAMICS S120

- Control Units
- Power Modules (blocksize, chassis)
- Line Modules (booksize, chassis)

- Line-side components
- Motor Modules (booksize, chassis)
- DC link components
- Additional system components
- Encoder system connection
- MOTION-CONNECT® connection system

SIMOTION

- SIMOTION D

SINUMERIK solution line

- Control systems
- Operator components for CNC controls

How up-to-date are the dimension drawings

Note

Siemens AG reserves the right to change the dimensions of the motors as part of mechanical design improvements without prior notice. This means that dimensions drawings can go out-of-date. Up-to-date dimension drawings can be requested at no charge from your local SIEMENS representative.

4.3 Dimension drawings

1FT7 Compact natural cooling

For motor		Dimensions in mm (inches)											Flange 1 (1FT6-compatible)			
Shaft height	Type	DIN IEC	a ₁ P	b ₁ N	c ₁ LA	e ₁ M	f AB	f ₁ T	g ₂ -	o ₁ -	s ₂ S	i ₂ -	without brake		with brake	
													k LB	o -	k LB	o -
1FT7 Compact, type of construction IM B5, natural cooling with connector, without/with brake																
36	1FT7034		90 (3.54)	60 (2.36)	8 (0.31)	75 (2.95)	72 (2.83)	3 (0.12)	80 (3.15)	48 (1.89)	6.5 (0.26)	30 (1.18)	195 (7.68)	133 (5.24)	222 (8.74)	160 (6.30)
	1FT7036												243 (9.57)	181 (7.13)	270 (10.63)	208 (8.19)
48	1FT7042		120 (4.72)	80 (3.15)	10 (0.39)	100 (3.94)	96 (3.78)	3 (0.12)	93 (3.66)	53 (2.09)	6.5 (0.26)	40 (1.57)	169 (6.65)	102 (4.02)	201 (7.91)	134 (5.28)
	1FT7044												219 (8.62)	152 (5.98)	251 (9.88)	184 (7.24)
	1FT7046												259 (10.20)	192 (7.56)	291 (11.46)	224 (8.82)
63	1FT7062		155 (6.10)	110 (4.33)	10 (0.39)	130 (5.12)	126 (4.96)	3.5 (0.14)	108 (4.25)	53 (2.09)	9 (0.35)	50 (1.97)	173 (6.81)	106 (4.17)	208 (8.19)	141 (5.55)
	1FT7064												205 (8.07)	137 (5.39)	240 (9.45)	173 (6.81)
	1FT7066												236 (9.29)	169 (6.65)	272 (10.71)	204 (8.03)
	1FT7068												284 (11.18)	216 (8.50)	319 (12.56)	252 (9.92)

Shaft height	Type	DIN IEC	Flange 0			without brake				with brake				DE shaft extension				
			b ₂ -	f ₂ -	i ₂ -	k LB	o -	k LB	o -	d D	d ₆ -	l E	t GA	u F				
36	1FT7034		36 (1.42)	5.5 (0.22)	36.5 (1.44)	189 (7.44)	127 (5.00)	216 (8.50)	154 (6.06)	14 (0.55)	M5	30 (1.18)	16 (0.63)	5 (0.20)				
	1FT7036					237 (9.33)	175 (6.89)	264 (10.39)	202 (7.95)									
48	1FT7042		46 (1.81)	5.5 (0.22)	46 (1.81)	163 (6.42)	96 (3.78)	195 (7.68)	128 (5.04)	19 (0.75)	M6	40 (1.57)	21.5 (0.85)	6 (0.24)				
	1FT7044					213 (8.39)	146 (5.75)	245 (9.65)	178 (7.01)									
	1FT7046					253 (9.96)	186 (7.32)	285 (11.22)	218 (8.58)									
63	1FT7062		51 (2.01)	6 (0.24)	56.5 (2.22)	167 (6.57)	99 (3.90)	202 (7.95)	135 (5.31)	24 (0.94)	M8	50 (1.97)	27 (1.06)	8 (0.31)				
	1FT7064					198 (7.80)	131 (5.16)	233 (9.17)	166 (6.54)									
	1FT7066					230 (9.06)	162 (6.38)	265 (10.43)	198 (7.80)									
	1FT7068					277 (10.91)	210 (8.27)	312 (12.28)	245 (9.65)									

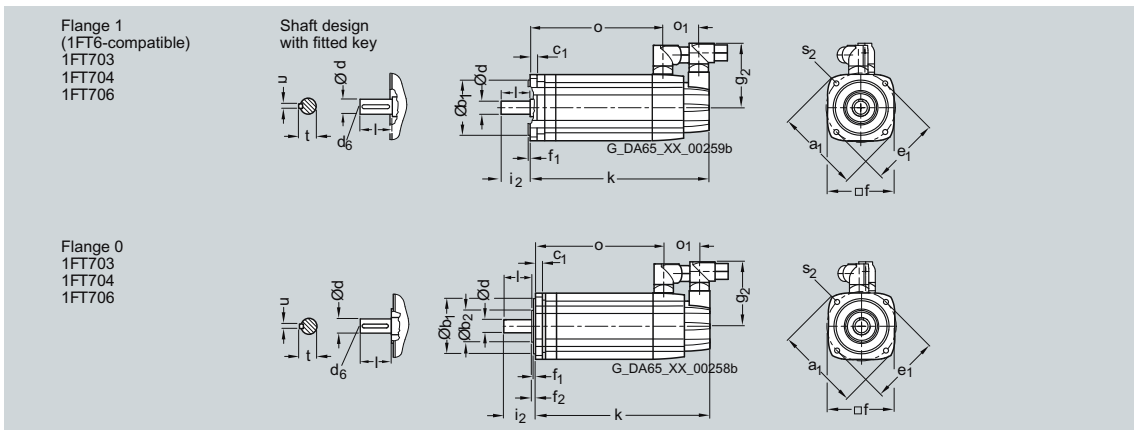

1FT7 Compact natural cooling

For motor		Dimensions in mm (inches)																
Shaft height	Type	DIN IEC	a ₁ P	b ₁ N	c ₁ LA	e ₁ M	f AB	f ₁ T	Connector				Flange 1 (1FT6-compatible)					
									Size 1		Size 1.5		without brake		with brake			
									g ₁ -	g ₁ -	o ₁ -	s ₂ S	i ₂ -	k LB	o -	k LB	o -	
1FT7 Compact, type of construction IM B5, natural cooling, with connector, without/with brake																		
80	1FT7082		195 (7.68)	130 (5.12)	11.5 (0.45)	165 (6.50)	155 (6.10)	3.5 (0.14)	119 (4.69)	141 (5.55)	51 (2.01)	11 (0.43)	58 (2.28)	196 (7.72)	130 (5.12)	248 (9.76)	183 (7.20)	
	1FT7084													247 (9.72)	182 (7.17)	299 (11.77)	234 (9.21)	
	1FT7086													299 (11.77)	234 (9.21)	351 (13.82)	286 (11.26)	
100	1FT7102		245 (9.65)	180 (7.09)	13 (0.51)	215 (8.46)	196 (7.72)	4 (0.16)	-	161 (6.34)	56 (2.20)	14 (0.55)	80 (3.15)	221 (8.70)	151 (5.94)	273 (10.75)	203 (7.99)	
	1FT7105													307 (12.09)	238 (9.37)	360 (14.17)	290 (11.42)	
	1FT7108													377 (14.84)	307 (12.09)	429 (16.89)	359 (14.13)	

Shaft height	Type	DIN IEC	Flange 0			without brake				with brake		DE shaft extension				
			b ₂ -	f ₂ -	i ₂ -	k LB	o -	k LB	o -	d D	d ₆ -	l E	t GA	u F		
80	1FT7082		66 (2.60)	6 (0.24)	64.5 (2.54)	189 (7.44)	124 (4.88)	241 (9.49)	176 (6.93)	32 (1.26)	M12	58 (2.28)	35 (1.38)	10 (0.39)		
	1FT7084					241 (9.49)	175 (6.89)	293 (11.54)	228 (8.98)							
	1FT7086					292 (11.50)	227 (8.94)	345 (13.58)	279 (10.98)							
100	1FT7102		81 (3.19)	6.5 (0.26)	87 (3.43)	214 (8.43)	144 (5.67)	266 (10.47)	196 (7.72)	38 (1.50)	M12	80 (3.15)	41 (1.61)	10 (0.39)		
	1FT7105					301 (11.85)	231 (9.09)	353 (13.90)	283 (11.14)							
	1FT7108					370 (14.57)	300 (11.81)	422 (16.61)	352 (13.86)							

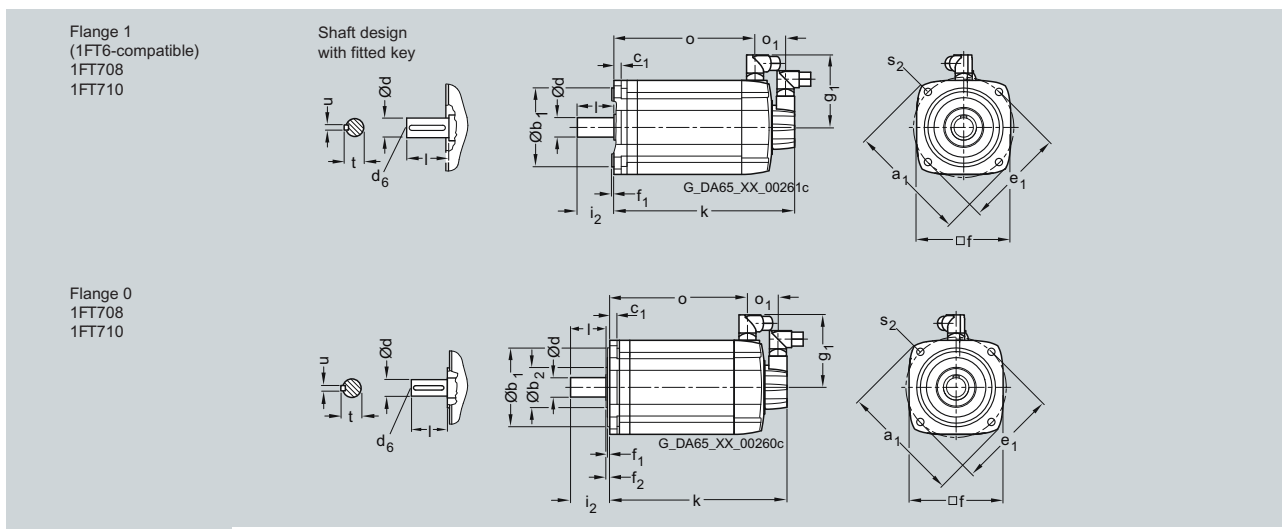

4.3 Dimension drawings

1FT7 Compact forced ventilation

For motor		Dimensions in mm (inches)															
Shaft height	Type	DIN IEC	a ₁ P	b	b ₁ N	c ₁ LA	e ₁ M	f AB	f ₁ T	Connector			Fan				
										Size 1.5	Size 3	g ₁	g ₃	h H	h ₁	h ₂	o ₁
1FT7 Compact, type of construction IM B5, forced ventilation, with connector, without/with brake																	
80	1FT7084		194 (7.64)	186 (7.32)	130 (5.12)	11.5 (0.45)	165 (6.50)	155 (6.10)	3.5 (0.14)	139 (5.47)	-	137.5 (5.41)	27 (1.06)	177 (6.97)	186.5 (7.34)	50 (1.97)	11 (0.43)
	1FT7086																
100	1FT7105		245 (9.65)	224 (8.82)	180 (7.09)	13 (0.51)	215 (8.46)	196 (7.72)	4 (0.16)	159 (6.26)	187 (7.36)	151 (5.94)	27 (1.06)	220 (8.66)	222 (8.74)	55 (2.17)	14 (0.55)

Shaft height	Type	DIN IEC	Flange 1 (1FT6-compatible)					Flange 0					DE shaft extension						
			i ₂	without brake		with brake		b ₂	f ₂	i ₂	without brake		with brake		d D	d ₆	l E	t GA	u F
80	1FT7084		58 (2.28)	342 (13.46)	182 (7.17)	394 (15.51)	234 (9.21)	66 (2.60)	6 (0.24)	64.5 (2.54)	335.5 (13.21)	175 (6.89)	387.5 (15.26)	228 (8.98)	32 (1.26)	M12	58 (2.28)	35 (1.38)	10 (0.39)
	1FT7086			393.5 (15.49)	234 (9.21)	446 (17.56)	286 (11.26)				387 (15.24)	227 (8.94)	439.5 (17.30)	279 (10.98)					
100	1FT7105		80 (3.15)	403.5 (15.89)	238 (9.37)	455.5 (17.93)	290 (11.42)	81 (3.19)	6.5 (0.26)	87 (3.43)	396.5 (15.61)	231 (9.09)	448.5 (17.66)	283 (11.14)	38 (1.50)	M12	80 (3.15)	41 (1.61)	10 (0.39)

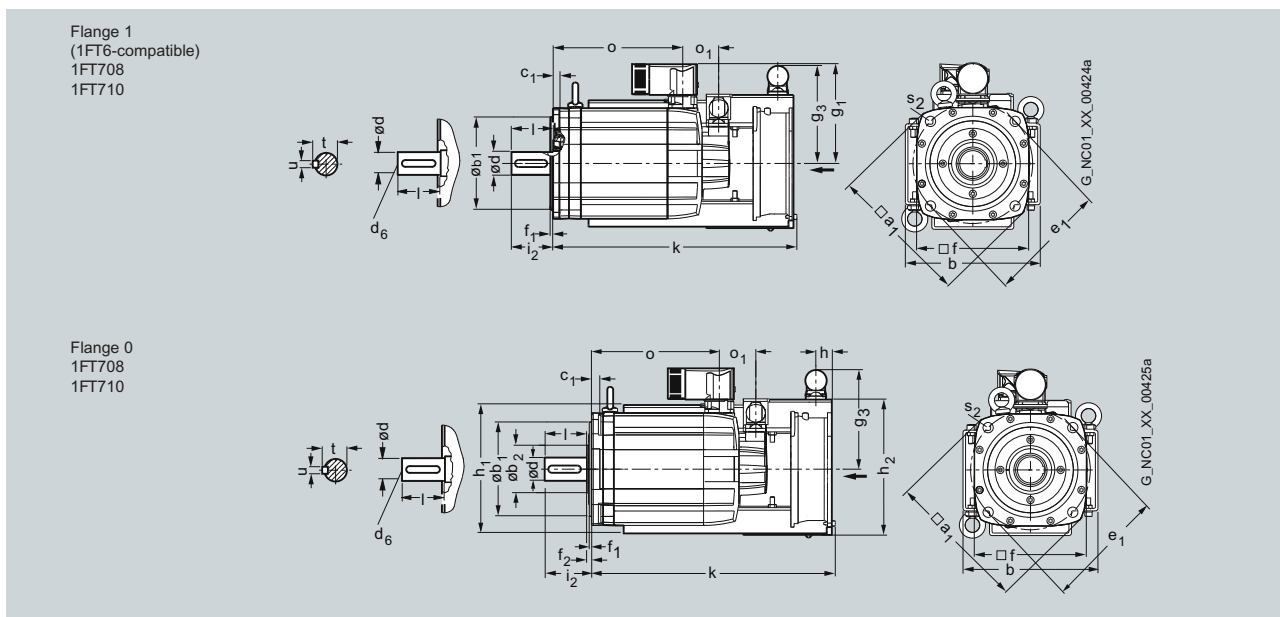

1FT7 Compact liquid cooling

For motor		Dimensions in mm (inches)														
Shaft height	Type	DIN IEC	a ₁ P	b	b ₁ N	c ₁ LA	e ₁ M	f AB	f ₁ T	Connector			Connector			S ₂ S
										Size 1	Size 1.5	Size 3	Size 1	Size 1.5	Size 3	
1FT7 Compact, type of construction IM B5, water cooling, with connector, without/with brake																
63	1FT7062 1FT7064 1FT7066 1FT7068		155 (6.10)	135 (5.31)	110 (4.33)	10 (0.39)	130 (5.12)	126 (4.96)	3.5 (0.14)	108 (4.25)	-	-	52 (2.05)	-	-	9 (0.35)
80	1FT7082 1FT7084 1FT7086		195 (7.68)	165 (6.50)	130 (5.12)	11.5 (0.45)	165 (6.50)	155 (6.10)	3.5 (0.14)	-	140 (5.51)	-	-	50 (1.97)	-	11 (0.43)
100	1FT7102 1FT7105 1FT7108		245 (9.65)	206 (8.11)	180 (7.09)	13 (0.51)	215 (8.46)	196 (7.72)	4 (0.16)	-	160 (6.30)	-	-	55 (2.17)	-	14 (0.55)
											-	187 (7.36)	-	72 (2.83)		

Shaft height	Type	DIN IEC	Flange 1 (1FT6-compatible)			Flange 0			DE shaft extension										
			without/with brake			without/with brake													
			Connector			Connector													
		i ₂	k LB	o	o	o	b ₂	f ₂	i ₂	k LB	o	o	o	d D	d ₆	l E	t GA	u F	
63	1FT7062		50 (1.97)	208 (8.19)	141 (5.55)	-	-	51 (2.01)	6 (0.24)	56.5 (2.22)	202 (7.95)	135 (5.31)	-	-	24 (0.94)	M8	50 (1.97)	27 (1.06)	8 (0.31)
	1FT7064			240 (9.45)	173 (6.81)	-	-				233 (9.17)	166 (6.54)	-	-					
	1FT7066			272 (10.71)	204 (8.03)	-	-				265 (10.43)	198 (7.80)	-	-					
	1FT7068			319 (12.56)	252 (9.92)	-	-				312 (12.28)	245 (9.65)	-	-					
80	1FT7082		58 (2.28)	248 (9.76)	-	183 (7.20)	-	66 (2.60)	6 (0.24)	64.5 (2.54)	241 (9.49)	-	176 (6.93)	32 (1.26)	M12	58 (2.28)	35 (1.38)	10 (0.39)	
	1FT7084			299 (11.77)	-	234 (9.21)	-				293 (11.54)	-	228 (8.98)						
	1FT7086			351 (13.82)	-	286 (11.26)	-				345 (13.58)	-	279 (10.98)						
100	1FT7102		80 (3.15)	273 (10.75)	-	203 (7.99)	-	81 (3.19)	6.5 (0.26)	87 (3.43)	266 (10.47)	-	196 (7.72)	38 (1.50)	M12	80 (3.15)	41 (1.61)	10 (0.39)	
	1FT7105			360 (14.17)	-	290 (11.42)	273 (10.75)				353 (13.90)	-	283 (11.14)	266 (10.47)					
	1FT7108			429 (16.89)	-	359 (14.13)	342 (13.46)				422 (16.61)	-	352 (13.86)	335 (13.19)					

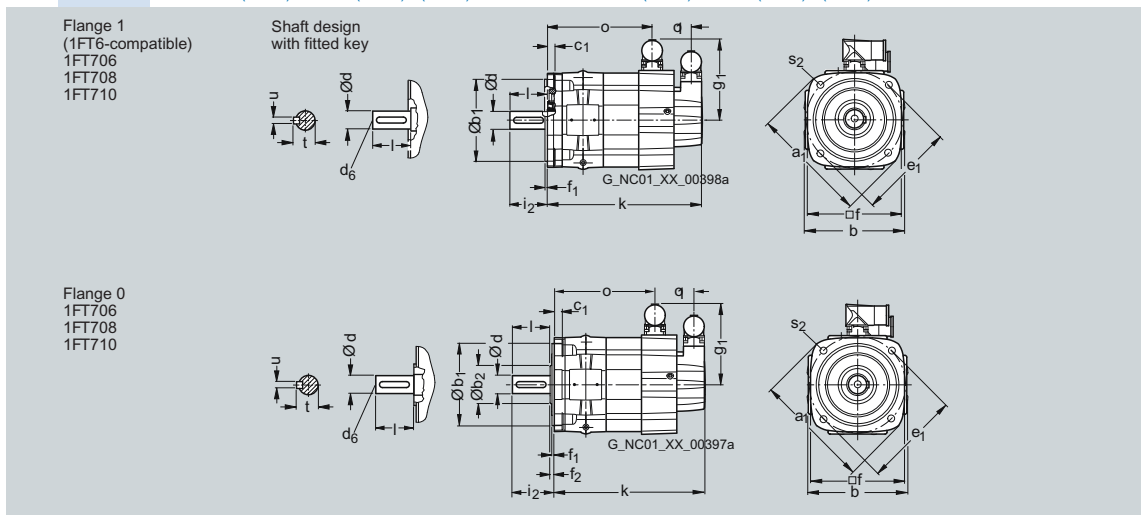

4.3 Dimension drawings

1FT7 High Dynamic forced ventilation

For motor		Dimensions in mm (inches)														
Shaft height	Type	DIN IEC	a ₁ P	b A	b ₁ N	c ₁ LA	e ₁ M	f AB	f ₁ T	Connector Size			Fan			
										g ₁ -	g ₃ -	h H	h ₁ -	h ₂ -	o ₁ -	s ₂ S
1FT7 High Dynamic, forced ventilation, with connector, without/with brake																
63	1FT7065 1FT7067		155 (6.10)	158 (6.22)	110 (4.33)	10 (0.39)	130 (5.12)	126 (4.96)	3.5 (0.14)	125 (4.92)	101.5 (4.00)	26 (1.02)	143 (5.63)	135 (5.31)	57 (2.24)	9 (0.35)

Shaft height	Type	DIN IEC	Flange 1 (1FT6-compatible)				Flange 0			without brake		with brake		DE shaft extension					
			i ₂ -	k LB	o -	k LB	o -	b ₂ -	f ₂ -	i ₂ -	k LB	o -	k LB	o -	d D	d ₆ -	l E	t GA	u F
63	1FT7065 1FT7067		50 (1.97)	380 (14.96)	220 (8.66)	380 (14.96)	220 (8.66)	51 (2.01)	6 (0.24)	56.5 (2.22)	373.5 (14.70)	214 (8.43)	373.5 (14.70)	214 (8.43)	24 (0.94)	M8	50 (1.97)	27 (1.06)	8 (0.31)
				420 (16.54)	260 (10.24)	420 (16.54)	260 (10.24)				413.5 (16.28)	254 (10.00)	413.5 (16.28)	254 (10.00)					

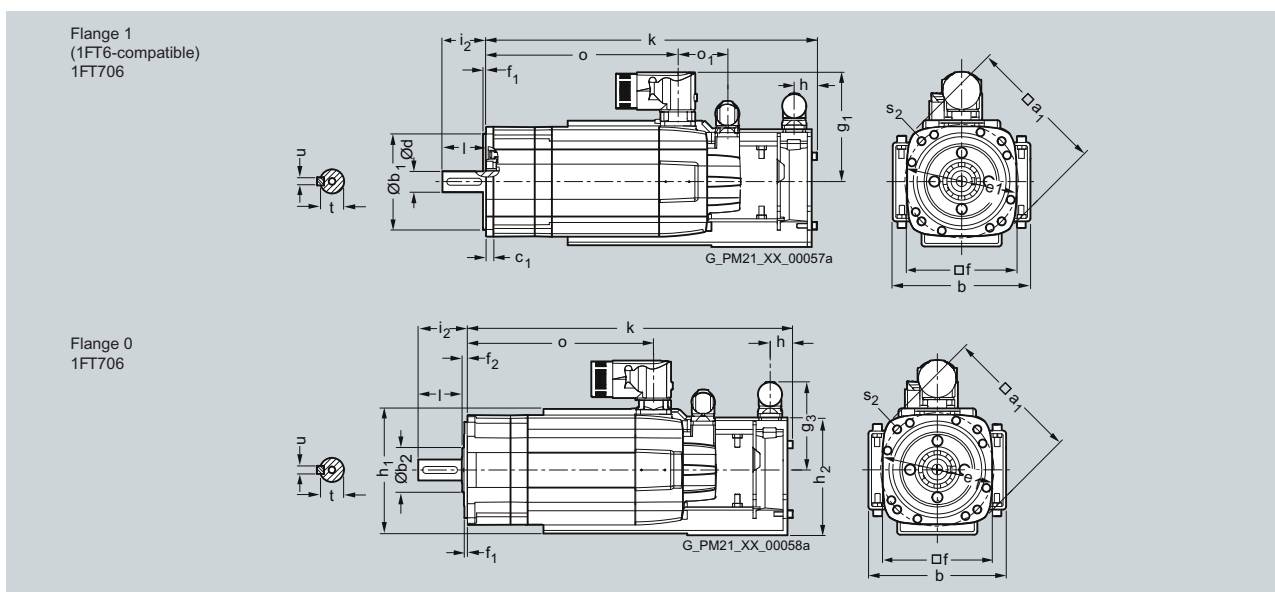

1FT7 High Dynamic forced ventilation

For motor		Dimensions in mm (inches)															
Shaft height	Type	DIN IEC	a ₁ P	b A	b ₁ N	c ₁ LA	e ₁ M	f AB	f ₁ T	Connector Size			h H	h ₁	Fan		
										1	3	g ₃			h ₂	o ₁	s ₂ S
1FT7 High Dynamic, forced ventilation, with connector, without/with brake																	
80	1FT7085		194 (7.64)	186 (7.32)	130 (5.12)	11.5 (0.45)	165 (6.50)	155 (6.10)	3.5 (0.14)	139 (5.47)	166.5 (6.56)	137.5 (5.41)	27 (1.06)	177 (6.97)	186.5 (7.34)	50 (1.97)	11 (0.43)
	1FT7087										166.5 (6.56)						

Shaft height	Type	DIN IEC	Flange 1 (1FT6-compatible)				Flange 0						DE shaft extension						
			i ₂	without brake		with brake		b ₂	f ₂	i ₂	without brake		with brake		d D	d ₆	l E	t GA	u F
80	1FT7085		58 (2.28)	414 (16.30)	254 (10.00)	414 (16.30)	254 (10.00)	66 (2.60)	6 (0.24)	64.5 (2.54)	407.5 (16.04)	247 (9.72)	407.5 (16.04)	247 (9.72)	32 (1.26)	M12	58 (2.28)	35 (1.38)	10 (0.39)
	1FT7087			474 (18.66)	314 (12.36)	474 (18.66)	314 (12.36)				467.5 (18.41)	307 (12.09)	467.5 (18.41)	307 (12.09)					

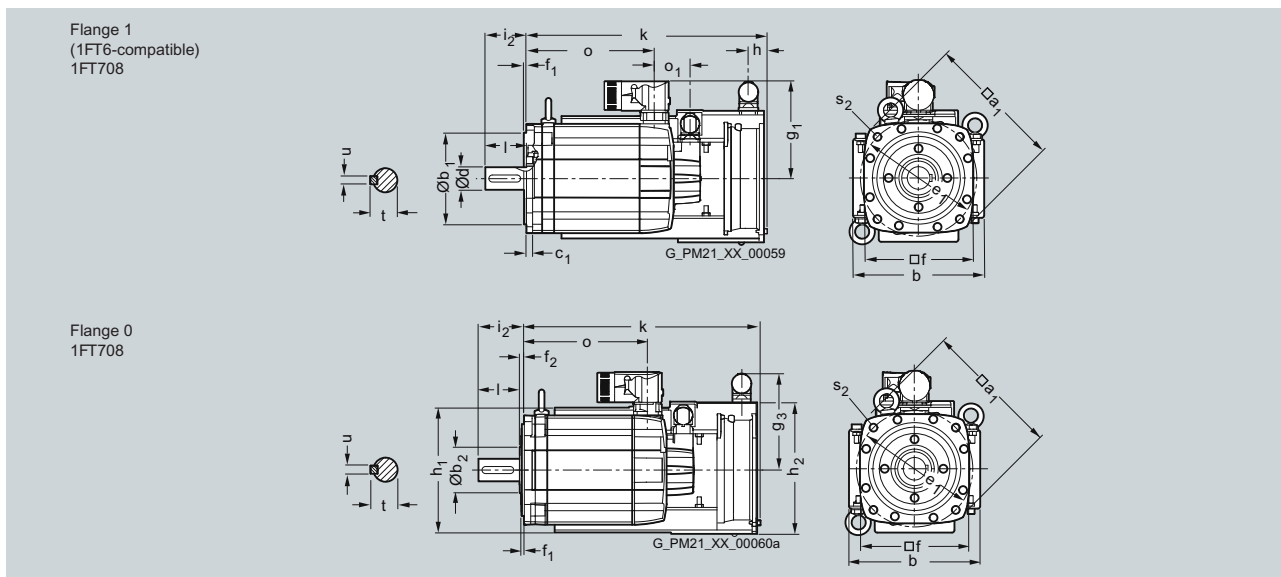

4.3 Dimension drawings

1FT7 High Dynamic liquid cooling

For motor		Dimensions in mm (inches)											
Shaft height	Type	DIN IEC P	a ₁ A	b N	b ₁ N	c ₁ LA	e ₁ M	f AB	f ₁ T	Connector Size		o ₁	s ₂ S
										1.5	3		
										g ₁	g ₁		
1FT7 High Dynamic, water cooling, with connector, without/with brake													
63	1FT7065		155 (6.10)	135 (5.31)	110 (4.33)	10 (0.39)	130 (5.12)	126 (4.96)	3.5 (0.14)	132.5 (5.22)	-	57 (2.24)	9 (0.35)
	1FT7067												
80	1FT7085		194 (7.64)	165 (6.50)	130 (5.12)	11.5 (0.45)	165 (6.50)	155 (6.10)	3.5 (0.14)	140.5 (5.53)	168.5 (6.63)	50 (1.97)	11 (0.43)
	1FT7087												

Shaft height	Type	DIN IEC	Flange 1 (1FT6-compatible)				Flange 0				DE shaft extension								
			i ₂	without brake		with brake		b ₂	f ₂	i ₂	without brake		with brake		d D	d ₆	l E	t GA	u F
				k LB	o	k LB	o				k LB	o	k LB	o					
63	1FT7065		50 (1.97)	292 (11.50)	220 (8.66)	292 (11.50)	220 (8.66)	51 (2.01)	6 (0.24)	56.5 (2.22)	285.5 (11.24)	214 (8.43)	285.5 (11.24)	214 (8.43)	24 (0.94)	M8	50 (1.97)	27 (1.06)	8 (0.31)
	1FT7067			332 (13.07)	260 (10.24)	332 (13.07)	260 (10.24)				325.5 (12.81)	254 (10.00)	325.5 (12.81)	254 (10.00)					
80	1FT7085		58 (2.28)	319 (12.56)	254 (10.00)	319 (12.56)	254 (10.00)	66 (2.60)	6 (0.24)	64.5 (2.54)	312.5 (12.30)	247 (9.72)	312.5 (12.30)	247 (9.72)	32 (1.26)	M12	58 (2.28)	35 (1.38)	10 (0.39)
	1FT7087			379 (14.92)	314 (12.36)	379 (14.92)	314 (12.36)				372.5 (14.67)	307 (12.09)	372.5 (14.67)	307 (12.09)					

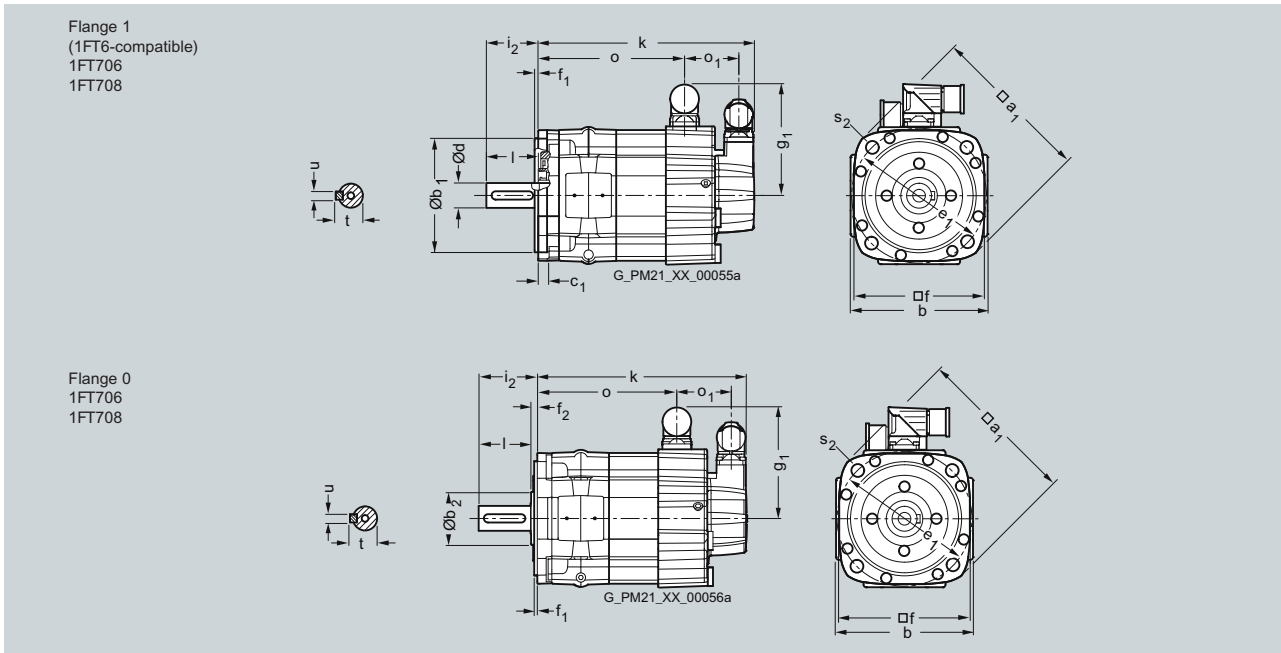

1FT7 planetary gearbox SP+, 1-stage

For motors				Dimensions in mm (inches)								Encoder system: Incremental encoder Absolute encoder		
Shaft height	Type	F4	Planetary gearbox Type	D1	D2	D3	D4	L5	L6	L7	L8	without brake	with brake	
												K	K	
1FT7 with SP+ planetary gearbox, single-stage, type of construction IM B5, natural cooling, with connector, without/with brake														
36	1FT7034	62 (2.44)	SP060S-MF1	60 (2.36)	16 (0.63)	5.5 (0.22)	68 (2.68)	142 (5.59)	28 (1.10)	20 (0.79)	6 (0.24)	347 (13.66)	374 (14.72)	
	1FT7034	76 (2.99)	SP075S-MF1	70 (2.76)	22 (0.87)	6.6 (0.26)	85 (3.35)	163.8 (6.45)	36 (1.42)	20 (0.79)	7 (0.28)	361 (14.21)	388 (15.28)	
	1FT7036											297 (11.69)	324 (12.76)	
48	1FT7042		SP100S-MF1					167.5 (6.59)				275 (10.83)	307 (12.09)	
	1FT7044											325 (12.80)	357 (14.06)	
	1FT7046											365 (14.37)	397 (15.63)	
63	1FT7062		SP140S-MF1					210 (8.27)	58 (2.28)	30 (1.18)	10 (0.39)	375 (14.76)	407 (16.02)	
	1FT7064							217 (8.54)				296 (11.65)	331 (13.03)	
	1FT7066											327 (12.87)	362 (14.25)	
	1FT7068											359 (14.13)	394 (15.51)	
	1FT7068	141 (5.55)			130 (5.12)	40 (1.57)	11 (0.43)	165 (6.50)	274.3 (10.80)	82 (3.23)	30 (1.18)	12 (0.47)	439 (17.28)	474 (18.66)
80	1FT7082		SP180S-MF1					283.3 (11.15)				361 (14.21)	413 (16.26)	
	1FT7084											412 (16.22)	464 (18.27)	
	1FT7086											464 (18.27)	516 (20.31)	
	1FT7086	182 (7.17)			160 (6.30)	55 (2.17)	13.5 (0.53)	215 (8.46)	310 (12.20)	82 (3.23)	30 (1.18)	15 (0.59)	491 (19.33)	543 (21.38)
100	1FT7102		SP210S-MF1									412 (16.22)	464 (18.27)	
	1FT7105											498 (19.61)	550 (21.65)	
	1FT7108											568 (22.36)	620 (24.41)	
	1FT7105	215 (8.46)			180 (7.09)	75 (2.95)	17 (0.67)	250 (9.84)	385 (15.16)	105 (4.13)	38 (1.50)	17 (0.67)	542 (21.34)	594 (23.39)
	1FT7108												612 (24.09)	664 (26.14)

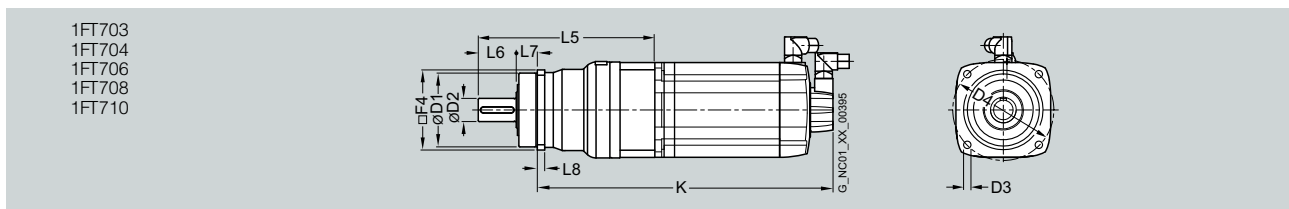

4.3 Dimension drawings

1FT7 planetary gearbox SP+, 2-stage

For motor		Dimensions in mm (inches)										Encoder system:	
Shaft height	Type	F4	Planetary gearbox Type	D1	D2	D3	D4	L5	L6	L7	L8	Incremental encoder	
												without brake	with brake
K													
1FT7 with SP+ planetary gearbox, two-stage, type of construction IM B5, natural cooling, with connector, without/with brake													
36	1FT7034	76 (2.99)	SP075S-MF2	70 (2.76)	22 (0.87)	6.6 (0.26)	85 (3.35)	179.4 (7.06)	36 (1.42)	20 (0.79)	7 (0.28)	376 (14.80)	403 (15.87)
	1FT7036											312 (12.28)	339 (13.35)
48	1FT7042							192 (7.56)				331 (13.03)	331 (13.03)
36	1FT7034	101 (3.98)	SP100S-MF2	90 (3.54)	32 (1.26)	9 (0.35)	120 (4.72)	230.3 (9.07)	58 (2.28)	30 (1.18)	10 (0.39)	395 (15.55)	422 (16.61)
	1FT7036											331 (13.03)	358 (14.09)
48	1FT7042							234 (9.21)				341 (13.43)	341 (13.43)
	1FT7044											359 (14.13)	391 (15.39)
	1FT7046											431 (16.97)	431 (16.97)
	1FT7044	141 (5.55)	SP140S-MF2	130 (5.12)	40 (1.58)	11 (0.43)	165 (6.50)	298.3 (11.74)	82 (3.23)	30 (1.18)	12 (0.47)	399 (15.71)	431 (16.97)
	1FT7046											471 (18.54)	471 (18.54)

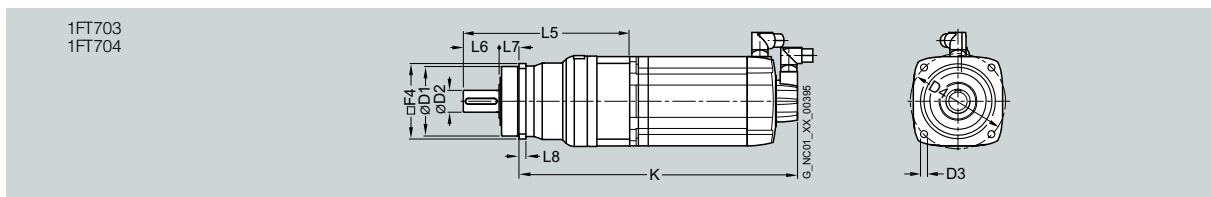

1FT7 planetary gearbox SP+, 2-stage

For motor		Dimensions in mm (inches)										Encoder system: Incremental encoder Absolute encoder	
Shaft height	Type	F4	Planetary gearbox Type	D1	D2	D3	D4	L5	L6	L7	L8	without brake K	with brake K
1FT7 with SP+ planetary gearbox, two-stage, type of construction IM B5, natural cooling, with connector, without/with brake													
63	1FT7062	101 (3.98)	SP100S-MF2	90 (3.54)	32 (1.26)	9 (0.35)	120 (4.72)	252 (9.92)	58 (2.28)	30 (1.18)	10 (0.39)	331 (13.03)	366 (14.41)
	1FT7064											362 (14.25)	397 (15.63)
63	1FT7062	141 (5.55)	SP140S-MF2	130 (5.12)	40 (1.57)	11 (0.43)	165 (6.50)	305 (12.01)	82 (3.23)	30 (1.18)	12 (0.47)	360 (14.17)	395 (15.55)
	1FT7064											391 (15.39)	426 (16.77)
	1FT7066											458 (18.03)	458 (18.03)
	1FT7068											505 (19.88)	505 (19.88)
80	1FT7082							332 (13.07)				410 (16.14)	462 (18.19)
	1FT7084											461 (18.15)	513 (20.20)
63	1FT7064	182 (7.17)	SP180S-MF2	160 (6.30)	55 (2.17)	13.5 (0.53)	215 (8.46)	346 (13.62)	82 (3.23)	30 (1.18)	15 (0.59)	432 (17.01)	467 (18.39)
	1FT7066											499 (19.65)	499 (19.65)
	1FT7068											546 (21.50)	546 (21.50)
80	1FT7082							355 (13.98)				433 (17.05)	485 (19.09)
	1FT7084											536 (21.10)	536 (21.10)
	1FT7086											536 (21.10)	588 (23.15)
100	1FT7102										457 (17.99)	509 (20.04)	
80	1FT7084	215 (8.46)	SP210S-MF2	180 (7.09)	75 (2.95)	17 (0.67)	250 (9.84)	415 (16.34)	105 (4.13)	38 (1.50)	17 (0.67)	565 (22.24)	565 (22.24)
	1FT7086											617 (24.29)	617 (24.29)
100	1FT7102											538 (21.18)	538 (21.18)
	1FT7105											572 (22.52)	624 (24.57)
	1FT7108											694 (27.32)	694 (27.32)
80	1FT7086	245 (9.65)	SP240S-MF2	200 (7.87)	85 (3.35)	17 (0.67)	290 (11.42)	467.5 (18.41)	130 (5.12)	40 (1.57)	20 (0.79)	643 (25.31)	643 (25.31)
100	1FT7102											512 (20.16)	564 (22.20)
	1FT7105											598 (23.54)	650 (25.59)
	1FT7108											668 (26.30)	720 (28.35)

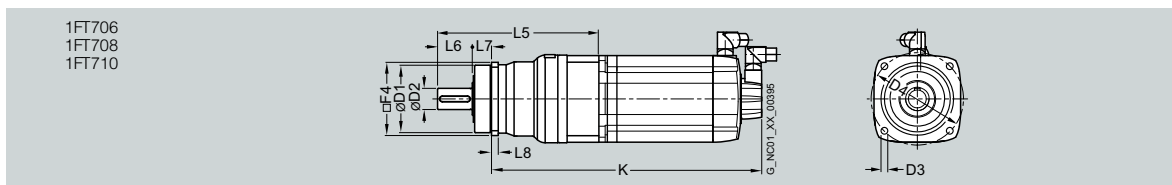

Motor components

5.1 Thermal motor protection

A temperature-dependent resistor is integrated as temperature sensor to monitor the motor temperature.

Table 5- 1 Features and technical data

Type	KTY 84
Resistance when cold (20 °C)	approx. 580 Ω
Resistance when hot (100 °C)	approx. 1000 Ω
Connection	via signal cable

CAUTION

The polarity must be carefully observed.

The resistance of the KTY 84 thermistor changes proportionally to the winding temperature change (refer to the following Fig.).

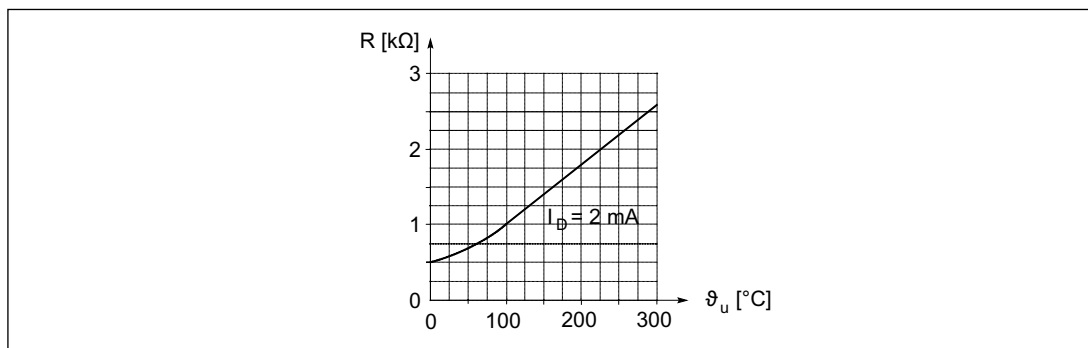

Figure 5-1 Resistance characteristic of the KTY 84 as a function of the temperature

The KTY 84 is evaluated in the converter whose closed-loop control takes into account the temperature characteristic of the motor winding. When a fault occurs, an appropriate message is output at the converter. When the motor temperature increases, a message "Alarm motor overtemperature" is output; this must be externally evaluated. If this signal is ignored, the converter shuts down with the appropriate fault message after a preset time period or when the motor limiting temperature or the shutdown temperature is exceeded.

 **CAUTION**

The integrated temperature sensor only protects the synchronous motors to a certain extent against overloads

Shaft heights 36 and 48 up to $2 \cdot I_{0(60K)}$ and speed $\neq 0$
from shaft height 63: up to $3 \cdot I_{0(60K)}$ and speed $\neq 0$

For load applications that are critical from a thermal perspective, e.g. overload when the motor is stationary or an overload of M_{max} longer than 4 s, adequate protection is no longer available. The "thermal motor model i^2t monitoring" function must be activated in the converter.

The temperature sensor is part of a SELV circuit, which can be destroyed if high voltage is applied. The temperature sensor is designed so that the DIN/EN requirement for "protective separation" is fulfilled.

5.2 Encoders

5.2.1 Encoder overview

The encoder is selected in the motor Order No. (MLFB) using the appropriate letter at the 14th position.

Table 5- 2 Encoders for 1FT7 SIMODRIVE motors

Encoder type	Order number (MLFB)
Incremental encoder sin/cos 1 Vpp 2048 S/R with C and D track (IC2048S/R encoder)	N
Absolute encoder EnDat 2048 S/R (AM2048S/R encoder)	M

The encoders can be replaced without adjustment.

Incremental encoders are referenced each time the system starts.

NOTICE
Re-referencing is required after replacement in the case of absolute encoders, as the number of full revolutions is initially undetermined.

With 1FT7, all encoders are suitable for Safety Integrated.

5.2.2 Incremental encoders

Function:

- Angular measuring system for the commutation
- Speed actual value sensing
- Indirect incremental measuring system for the position control loop
- One zero pulse (reference mark) per revolution

Table 5- 3 Technical data for incremental encoders

Properties	Incremental encoder sin/cos 1 Vpp (IC2048S/R encoder)
Mech. limiting speed	12000 rpm
Operating voltage	5 V \pm 5%
Current consumption	Max. 150 mA
A-B track: Resolution incremental (sin/cos periods per revolution)	2048 S/R (1 Vpp)
C-D track: rotor position (sin/cos periods per revolution)	1 S/R (1 Vpp)
Reference signal	1 per revolution
Angular error	\pm 40"

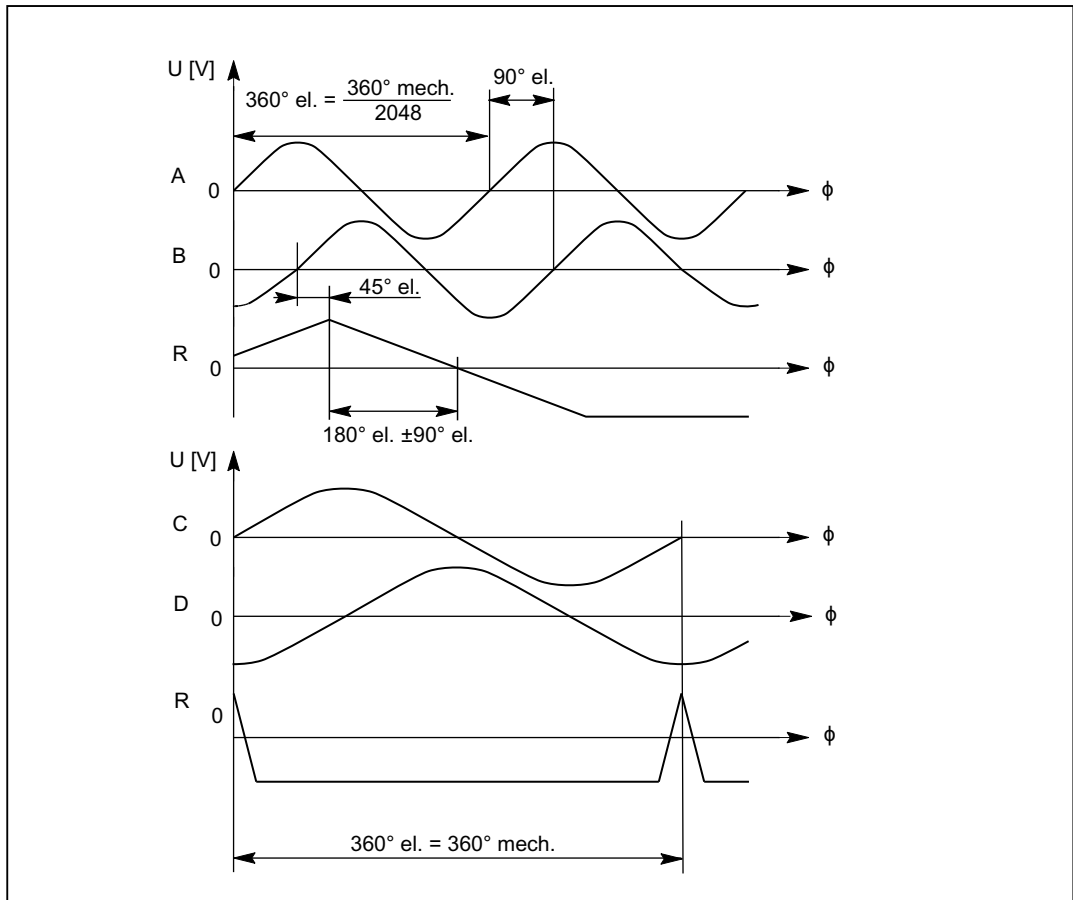

Figure 5-2 Signal sequence and assignment for a positive direction of rotation

5.2.3 Absolute encoder

Function:

- Angular measuring system for the commutation
- Speed actual value sensing
- Indirect measuring system for absolute position determination within a revolution
- Indirect measuring system for absolute position determination within a traversing range of 4096 revolutions
- Indirect incremental measuring system for the position control loop

Table 5- 4 Technical data, absolute encoder

Features	Absolute encoder EnDat (AM2048S/R encoder)
Mech. limiting speed	12000 rpm
Operating voltage	5 V \pm 5%
Current consumption	300 mA, maximum
Absolute resolution (singleturn)	8192
Traversing range (multiturn)	4096 revolutions
A-B track: Resolution incremental (sin/cos periods per revolution)	2048 S/R (1 Vpp)
Angular error	\pm 40"
Serial absolute position interface	EnDat 2.1

Signal sequence and assignment of the A-B track, referred to the diagram "Incremental encoders"

5.3 Holding brake (option)

5.3.1 Properties

- The holding brake is used to clamp the motor shaft when the motor is at a standstill. The holding brake is **not** a working brake that is used to brake a motor that is still rotating.
- Restricted Emergency Stop operation is permissible. Up to 2000 braking operations can be executed with 300% rotor moment of inertia as external moment of inertia from a speed of 3000 RPM without the brake being subject to an inadmissible amount of wear. The specific highest switching work for each emergency braking operation may not be exceeded.
- The rated voltage of the holding brake is 24 VDC.

 **CAUTION**

The rated voltage is 24 VDC +/- 10%. Voltages outside this tolerance bandwidth can result in faults.

Inadmissible wear means that the braking function can no longer be guaranteed! It is not permissible to exceed the above specified Emergency Stop conditions or to repeatedly briefly accelerate the motor against a holding brake that is still closed. This means that the switching times of the brakes and relays must be taken into account in the drive control and enable functions.

NOTICE

Motors with or without holding brake cannot be subsequently retrofitted!

Motors with holding brake are longer by the mounted space required (refer to the dimension drawings).

5.3.2 Permanent-magnet brake

The magnetic field of the permanent magnets results in a pulling force on the brake armature disk. This means that in the no-current condition, the brake is closed and the motor shaft is held.

When 24 V DC rated voltage is connected to the brake, the solenoid – through which current flows – establishes an opposing field. As a result the force of the permanent magnets is neutralized and the brake opens without residual torque on account of the spring return. The permanent magnet brake has torsion-proof connection to the rotor of the motor. This is the reason that this brake is almost without any play.

CAUTION

Motors with integrated permanent-magnet holding brake cannot be subject to axial forces at the shaft end! This applies when installing the system and during operation.

5.3.3 Connection of the holding brake to an external power supply via a contactor

The brake can be activated via an external power supply. Since safe electrical isolation from the motor winding is guaranteed for the brake cable in the motor and the power cable is designed as an enforced insulation, this can also be a PELV (PELV = protective extra low voltage) supply. The relay K1, located between coil and contact, must also have enforced insulation in order to protect the internal logic voltage.

In the case of an external activation, the brake has to be provided with a protective circuit (see Fig. "Suggested circuit for the external power supply"). This protective circuit avoids parasitic voltage peaks and guarantees the switching times indicated (see Table "Technical data of holding brakes used").

The minimum voltage of 24 V DC -10% must be available at the connector on the motor side in order to guarantee that the brake reliably opens. If the maximum voltage of 24 V DC +10% is exceeded, the brake could re-close. The voltage drop along the brake feeder cable must be taken into consideration. The voltage drop ΔU for copper cables can be approximately calculated as follows:

$$\Delta U [V] = 0.042 \cdot (l/q) \cdot I_{\text{brake}}$$

l = Cable length [m]

q = Brake core cross section [mm²]

I_{brake} = Direct current of the brake [A]

CAUTION

In order to avoid overvoltages when shutting down and the possible negative impact on the plant or system environment, a protective circuit must be integrated into the feeder cable (see figure below)

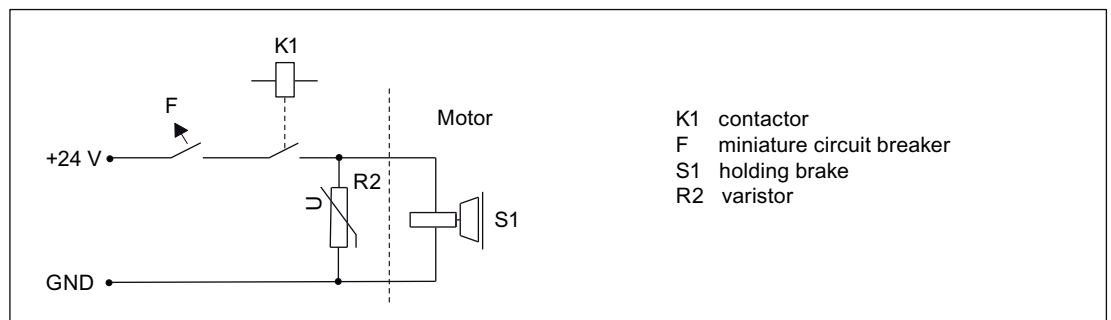

Figure 5-3 Suggested circuit for the external power supply with protective circuit

5.3 Holding brake (option)

Table 5- 5 Example: Electronic components for the recommended circuit

Electr. component	Examples		
F	3RV10 circuit-breaker with current paths connected in series (if required with mounted auxiliary contact 3RV1901 to provide a feedback signal for the drive).	or	Miniature circuit-breaker 5SX21 (if required with mounted auxiliary contact to provide a feedback signal for the drive).
K1	Auxiliary contactor 3RH11	or	Contacto 3RT10
R2	Varistor SIOVS14K30 (EPCOS)		

5.3.4 Technical data of the holding brake

Table 5- 6 Technical data of the holding brakes used for 1FT7 motors

Motor type	Holding torque M_4 at 120 °C	Dyn. braking torque M_1	Direct current at 20 °C	Opening time with varistor	Closing time with varistor	Highest switching energy
	[Nm]	[Nm]	[A]	[ms]	[ms]	[J]
1FT703□	3	1.5	0.3	60	25	30
1FT704□	8	5	0.6	90	30	270
1FT706□	18	11	0.8	150	50	880
1FT708□	48	25	1.0	220	65	1900
1FT710□	85	35	1.6	250	70	5300

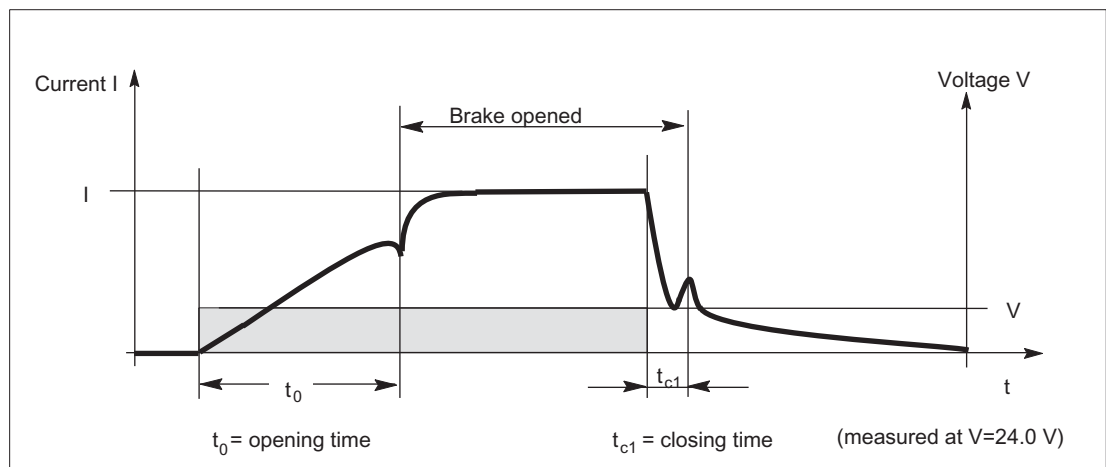

Figure 5-4 Terminology (time) for holding operation

Holding torque M_4

The holding torque M_4 is the highest permissible torque with which the closed brake can be loaded in steady-state operation without slip (holding function when motor is stationary).

Dynamic braking torque M_1

The dynamic braking torque M_1 is the smallest mean dynamic braking torque that can occur in emergency stop operation.

5.4 Gearboxes

5.4.1 Dimensioning the gearbox

Overview

- The following influencing parameters should be taken into consideration:
 - acceleration torque, permanent torque, number of cycles, cycle type, permissible input speed, mounting position, torsional backlash, torsional stiffness, and radial and axial forces.
 - Worm gearboxes are only conditionally suitable for reversing operation with servo applications.
- Technical data should be obtained from the catalogs of the gearbox manufacturers and similar sources.
- If the gearbox oil is in contact with the motor flange, then suitable shaft and flange seals must be selected.

Dimensioning for S3 duty

When engineering geared drive systems you can use the motor characteristic without reduction. Please note the permissible maximum torque and the permissible gearbox input speed.

$$M_{Mot} = M_{out} / (i \cdot \eta_G)$$

The motor and gearbox are assigned as follows: $M_{max, gear} \geq M_{0 (100 K)} \cdot i \cdot f$

$M_{max, gear}$	Max. permissible drive torque
$M_{0 (100 K)}$	Motor static torque
i	Gear ratio
f	Supplementary factor $f = f_1 \cdot f_2$

$f_1 = 2$	for motor accelerating torque
$f_2 = 1$	for ≤ 1000 gearbox switching cycles / h
$f_2 > 1$	for > 1000 switching cycles / h (refer to the gearbox catalog)
e.g. $f_2 = 1.5$	for 3000 switching cycles / h
$f_2 = 1.8$	for 5000 switching cycles / h
$f_2 = 2.0$	for 8000 switching cycles / h

NOTICE

Switching cycles can also be superimposed vibration! The supplementary factor (f_2) is then not sufficient when dimensioning the gearbox and gearboxes may fail.

The complete system should be optimized so that the higher-level vibration is minimized.

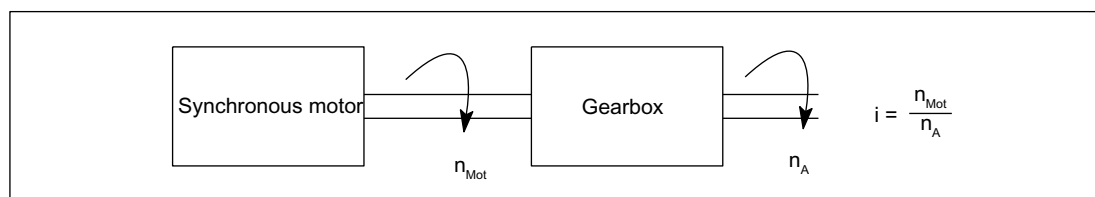

Figure 5-5 Gear ratio

The load torque and the required start-up velocity define the gearbox output torque, the output speed and therefore the output power.

The required drive power is calculated from this:

$$P_{\text{out}} [\text{W}] = P_{\text{mot}} [\text{W}] \cdot \eta_G = (\pi/30) \cdot M_{\text{mot}} [\text{Nm}] \cdot n_{\text{mot}} [\text{RPM}] \cdot \eta_G$$

Dimensioning for S1 duty

The gearbox itself generates heat due to friction and acts as a thermal barrier preventing heat from being dissipated through the motor flange. This is the reason that the torque must be reduced for S1 duty.

The required motor torque is calculated as follows:

$$M_{\text{Mot}} = \sqrt{\left(\frac{M_{\text{ab}}}{i \cdot \eta_G} + M_V \right)^2 - M_V^2} \quad \text{mit} \quad M_V = a \cdot b \cdot \frac{n_{\text{Mot}}}{60} (1 - \eta_G) \cdot \frac{k_T^2}{R_{\text{Strw}}}$$

M_{Mot}	Motor torque [Nm]
M_V	Calculated "torque loss" [Nm]
a	$\pi/3$ for 1FT7 motors supplied with sinusoidal current
b	Weighting factor for gearbox losses (without dimensions); $b = 0.5$
η_G	Gearbox efficiency
i	Gearbox ratio ($i > 1$)
k_T	Torque constant [Nm/A]
M_{out}	Gearbox output torque [Nm]
n_A	Output speed of gearbox [rpm]
n_{Mot}	Motor speed [rpm]
R_{Strw}	Resistance when hot of the motor phase [Ω]; $R_{\text{Strw}} = 1.4 \cdot R_{\text{Str}}$ (see chapter headed "Technical data and characteristics")
P_{out}	Gearbox output power [W]
P_{Mot}	Motor power [W]
π	$\pi = 3.1416$

Change to the characteristic when a gearbox is mounted

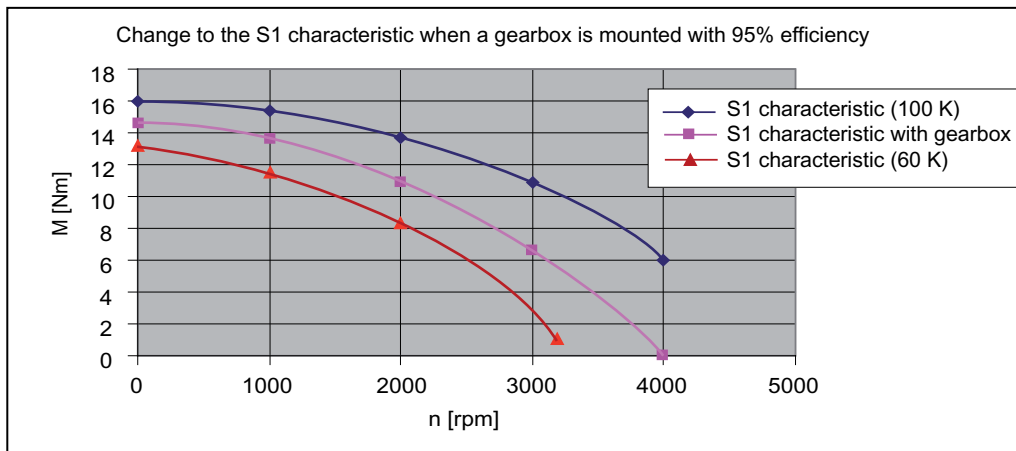

Figure 5-6 S1 characteristics (example)

Information for additional characteristics: $S1_{gearbox} = S1_{100 K} - (S1_{100 K} - S1_{60 K}) / 2$

Starting behavior of a motor when a gearbox is mounted

NOTICE

During commissioning, it should be assumed that an increased current will be drawn due to the lubrication characteristics (inadequate distribution of grease and oil) and the fact that the shaft sealing ring is being run-in.

5.4.2 Motors with planetary gearbox

Overview

1FT703□ to 1FT710□ motors can be supplied ex factory (Siemens AG) complete with a planetary gearbox. The gearboxes are flanged directly to the drive end of the motors.

When selecting the gearbox, ensure that its rated speed is not exceeded by the maximum speed of the motor. In the case of high operating frequencies, allowance must be made for the withstand ratio f_2 . The frictional losses of the gearbox must always be taken into account when engineering geared drives.

The gearboxes are only available in a non-balanced design.

Benefits

- High efficiency; single-stage: > 97 %, 2-stage: > 94 %
- Minimal torsional backlash; single-stage: ≤ 4 arcmin, 2-stage: ≤ 6 arcmin
- Power transmission from the central sun wheel via planet wheels
- No shaft deflections in the planet wheel set due to symmetrical force distribution
- Very low moment of inertia and thus short acceleration times of the motors
- The gearboxes are connected to the motor shaft via an integrated clamping hub A plain motor shaft end is necessary for this purpose. Shaft and flange accuracy tolerance N in accordance with DIN42955 and vibration magnitude grade A in accordance with EN 60034-14 are sufficient. The motor flange is adapted by means of adapter plates.
- Output shaft of gearbox exactly coaxial with the motor
- The gearboxes are sealed (seal between the gearbox and motor) and filled with oil at the factory. They are lubricated and sealed for their service life. The gearboxes are suitable for all mounting positions.
- Degree of protection of gearbox: IP65
- Small dimensions
- Low weight

Integration

The gearboxes assigned to the individual motors and the gear ratios available for these motor/gearbox combinations are listed in the selection table below. When making a selection, the maximum permissible input speed of the gearbox must be observed (this is the same as the maximum motor speed).

The motor/gearbox combinations listed in the selection tables below are mainly intended for cyclic operation S3 - 60% (ON period ≤ 60% and ≤ 20 min). Reduced maximum motor speeds and output torques apply for use in S1 continuous duty (ON period > 60% or > 20 min). The gearbox temperature may not exceed 90 °C

1FT7 motors to be implemented as follows for mounting to a gearbox:

- Flange "1"
- Plain motor shaft extension
- Shaft and flange accuracy tolerance N
- Vibration severity grade A
- IP65 degree of protection

Selection and ordering data for single-stage planetary gear, SP+ series

Motor Natural cooling	Planetary gearbox single-stage			Available gear ratio $i =$				Motor speed, max. S3-60 % n_{G1} (n_1) rpm	Output torque, max. S3-60 % M_{G2} (T_{2B}) Nm (lb _f -ft)	Radial output shaft loading, max. ¹⁾ F_r (F_{2Rmax}) N (lb _f)	Axial output shaft loading, max. ¹⁾ F_a (F_{2Amax}) N (lb _f)
	Type	Torsional back- lash arcmin	Gearbox weight, approx. kg (lb)	4	5	7	10				
1FT7034	SP 060S-MF1	≤ 4	1.9 (4.2)	✓	✓	✓	–	6000	40 (295)	2700 (607)	2400 (540)
1FT7034 1FT7036 1FT7042 1FT7044 1FT7046	SP 075S-MF1	≤ 4	3.9 (8.6)	–	–	–	✓	6000	110 (81.1) (90 for $i = 10$)	4000 (899)	3350 (753)
1FT7046 1FT7062 1FT7064 1FT7066 1FT7068	SP 100S-MF1	≤ 3	7.7 (17.0)	–	–	–	✓	4500	300 (221) (225 for $i = 10$)	6300 (1416)	5650 (1270)
1FT7068 1FT7082 1FT7084 1FT7086	SP 140S-MF1	≤ 3	17.2 (37.9)	–	–	–	✓	4000	600 (442) (480 for $i = 10$)	9450 (2124)	9870 (2219)
1FT7086 1FT7102 1FT7105 1FT7108	SP 180S-MF1	≤ 3	34 (75.0)	–	–	–	✓	3500	1100 (810) (880 for $i = 10$)	14700 (3305)	14150 (3181)
1FT7105 1FT7108	SP 210S-MF1	≤ 3	56 (123)	–	–	–	✓	2500	2500 (1844) (2400 for $i = 7$ 1900 for $i = 10$)	21000 (4721)	30000 (6744)

Order codes				
• Gear shaft with fitted key	J02	J03	J05	J09
• Gear shaft without fitted key	J22	J23	J25	J29

Ordering data **1FT7...-...71-.. 7 1-Z**
J7 7
G without holding brake
H with holding brake

Order No. of the motor with identifier "-Z" and order code for mounting the planetary gearbox assigned to the motor
 Preconditions for mounting planetary gearbox SP+:
 Plain motor shaft extension/shaft and flange accuracy tolerance N and vibration magnitude grade A/IP65 degree of protection

✓ Possible
 – Not possible
 1) In reference to the output shaft center.

Planetary gearbox with 1FT7 motor								
Single-stage Type	Gear ratio	Motor speed Continuous duty S1 ¹⁾ n_{N1} rpm	Output torque $M_{N2} (T_{2N})$ Nm (lb _f -ft)	Moments of inertia of gearbox (referred to the drive)				
				1FT703. J_1 kgcm ² (lb _f -in ²)	1FT704. J_1 kgcm ² (lb _f -in ²)	1FT706. J_1 kgcm ² (lb _f -in ²)	1FT708. J_1 kgcm ² (lb _f -in ²)	1FT710. J_1 kgcm ² (lb _f -in ²)
SP 060S-MF1	4	3300	26 (19.2)	0.22 (0.08)	–	–	–	–
	5	3300	26 (19.2)	0.20 (0.07)	–	–	–	–
	7	4000	26 (19.2)	0.18 (0.06)	–	–	–	–
SP 075S-MF1	4	2900	75 (55.3)	0.61 (0.21)	0.78 (0.27)	–	–	–
	5	2900	75 (55.3)	0.51 (0.17)	0.68 (0.23)	–	–	–
	7	3100	75 (55.3)	0.42 (0.14)	0.59 (0.20)	–	–	–
	10	3100	52 (38.4)	0.38 (0.13)	0.54 (0.19)	–	–	–
SP 100S-MF1	4	2500	180 (133)	–	–	3.04 (1.04)	–	–
	5	2500	175 (129)	–	–	2.61 (0.89)	–	–
	7	2800	170 (125)	–	–	2.29 (0.78)	–	–
	10	2800	120 (88.5)	–	1.38 (0.47)	2.07 (0.71)	–	–
SP 140S-MF1	4	2100	360 (266)	–	–	–	11.0 (3.76)	–
	5	2100	360 (266)	–	–	–	9.95 (3.40)	–
	7	2600	360 (266)	–	–	–	9.01 (3.08)	–
	10	2600	220 (162)	–	–	5.28 (1.80)	8.44 (2.88)	–
SP 180S-MF1	4	1500	750 (553)	–	–	–	–	33.9 (11.6)
	5	1500	750 (553)	–	–	–	–	27.9 (9.53)
	7	2300	750 (553)	–	–	–	–	22.2 (7.59)
	10	2300	750 (553)	–	–	–	19.2 (6.56)	19.2 (6.56)
SP 210S-MF1	10	2000	1000 (738)	–	–	–	–	53.1 (18.1)

¹⁾ The limit values in the table apply for S1 continuous duty (ON time > 60 % or > 20 min) for a maximum gearbox temperature of 90 °C (194 °F).

Selection and ordering data for two-stage planetary gear, SP+ series

Motor components

5.4 Gearboxes

Motor Natural cooling	Planetary gearbox two-stage			Available gear ratio $i =$					Motor speed, max. S3-60 % n_{G1} (n_1) rpm	Output torque, max. S3-60 % M_{G2} (T_{2B}) Nm (lb _f -ft)	Radial output shaft loading, max. ¹⁾ F_r (F_{2Rmax}) N (lb _f)	Axial output shaft loading, max. ¹⁾ F_a (F_{2Amax}) N (lb _f)
	Type	Torsional backlash arcmin	Gearbox weight, approx. kg (lb)	16	20	28	40	50				
1FT7034	SP 075S-MF2	≤ 6	3.6 (7.9)	✓	✓	✓	–	–	6000	110 (81.1)	4000 (899)	3350 (753)
1FT7036				✓	–	–	–	–				
1FT7042				✓	–	–	–	–				
1FT7034	SP 100S-MF2	≤ 5	7.9 (17.4)	–	–	–	✓	✓	4500	300 (221)	6300 (1416)	5650 (1270)
1FT7036				–	✓	✓	✓	✓				
1FT7042				–	✓	✓	✓	✓				
1FT7044				✓	✓	✓	–	–				
1FT7046				✓	✓	–	–	–				
1FT7062				✓	–	–	–	–				
1FT7064				✓	–	–	–	–				
1FT7064				–	–	–	–	–				
1FT7044	SP 140S-MF2	≤ 5	17 (37.5)	–	–	–	✓	✓	4000	600 (442)	9450 (2124)	9870 (2219)
1FT7046				–	–	✓	✓	✓				
1FT7062				–	–	✓	✓	✓				
1FT7064				–	✓	–	–	–				
1FT7066				✓	✓	–	–	–				
1FT7068				✓	✓	–	–	–				
1FT7082				✓	✓	–	–	–				
1FT7084				✓	–	–	–	–				
1FT7064	SP 180S-MF2	≤ 5	36.4 (80.3)	–	–	–	✓	✓	4000	1100 (811)	14700 (3305)	14150 (3181)
1FT7066				–	–	✓	✓	✓				
1FT7068				–	–	✓	✓	✓				
1FT7082				–	–	✓	✓	✓				
1FT7084				–	✓	✓	–	–				
1FT7086				✓	✓	–	–	–				
1FT7102				✓	✓	–	–	–				
1FT7084	SP 210S-MF2	≤ 5	55 (121)	–	–	–	✓	✓	3500	2400 (1770) (2500 for $i = 40$)	21000 (4721)	30000 (6744)
1FT7086				–	–	✓	✓	–				
1FT7102				–	–	✓	–	–				
1FT7105				✓	✓	–	–	–				
1FT7108				✓	–	–	–	–				
1FT7086	SP 240S-MF2	≤ 5	80.6 (178)	–	–	–	–	✓	3500	4500 (3319) (4000 for $i = 40$ 4300 for $i = 50$)	30000 (6744)	33000 (7419)
1FT7102				–	–	–	✓	✓				
1FT7105				–	–	✓	✓	–				
1FT7108				–	✓	✓	–	–				

Order codes						
• Gear shaft with fitted key	J12	J13	J15	J16	J17	
• Gear shaft without fitted key	J32	J33	J35	J36	J37	

Ordering data **1FT7...-...71-.. 7 1-Z**
J7 7
G without holding brake
H with holding brake

Order No. of the motor with identifier "**Z**" and order code for mounting the planetary gearbox assigned to the motor
 Preconditions for mounting planetary gearbox SP+:
 Plain motor shaft extension/shaft and flange accuracy tolerance N and vibration magnitude grade A/IP65 degree of protection

¹⁾ In reference to the output shaft center.

Planetary gearbox with 1FT7 motor								
Two-stage Type	Gear ratio	Motor speed Continuous duty S1 ¹⁾ n_{N1} rpm	Output torque $M_{N2} (T_{2N})$ Nm (lb _F -ft)	Moments of inertia of gearbox (referred to the drive)				
				1FT703 . J_1 kgcm ² (lb _F -in ²)	1FT704. J_1 kgcm ² (lb _F -in ²)	1FT706. J_1 kgcm ² (lb _F -in ²)	1FT708. J_1 kgcm ² (lb _F -in ²)	1FT710. J_1 kgcm ² (lb _F -in ²)
SP 075S-MF2	16	3500	75 (55.3)	0.23 (0.08)	0.55 (0.19)	–	–	–
	20	3500	75 (55.3)	0.20 (0.07)	–	–	–	–
	28	3500	75 (55.3)	0.18 (0.06)	–	–	–	–
SP 100S-MF2	16	3100	180 (133)	–	0.81 (0.28)	2.18 (0.75)	–	–
	20	3100	180 (133)	0.54 (0.19)	0.70 (0.24)	2.07 (0.71)	–	–
	28	3100	180 (133)	0.43 (0.15)	0.60 (0.21)	–	–	–
	40	3100	180 (133)	0.38 (0.13)	0.55 (0.19)	–	–	–
	50	3500	175 (129)	0.38 (0.13)	0.54 (0.19)	–	–	–
SP 140S-MF2	16	2900	360 (265)	–	–	3.19 (1.09)	10.3 (3.52)	–
	20	2900	360 (265)	–	–	2.71 (0.93)	9.77 (3.34)	–
	28	2900	360 (265)	–	1.65 (0.56)	2.34 (0.80)	–	–
	40	2900	360 (265)	–	1.40 (0.48)	2.10 (0.72)	–	–
	50	3200	360 (265)	–	1.39 (0.48)	2.08 (0.71)	–	–
SP 180S-MF2	16	2700	750 (553)	–	–	–	12.4 (4.24)	13.5 (4.61)
	20	2700	750 (553)	–	–	–	10.9 (3.73)	12.0 (4.10)
	28	2700	750 (553)	–	–	6.32 (2.16)	9.48 (3.24)	–
	40	2700	750 (553)	–	–	5.51 (1.88)	8.67 (2.96)	–
	50	2900	750 (553v)	–	–	5.45 (1.86)	8.61 (2.94)	–
SP 210S-MF2	16	2500	1500 (1106)	–	–	–	–	34.5 (11.8)
	20	2500	1500 (1106)	–	–	–	–	31.5 (10.8)
	28	2500	1500 (1106)	–	–	–	30.0 (10.3)	30.0 (10.3)
	40	2500	1500 (1106)	–	–	–	28.5 (9.74)	–
	50	2500	1500 (1106)	–	–	–	28.3 (9.67)	–
SP 240S-MF2	20	2500	2500 (1844)	–	–	–	–	34.6 (11.8)
	28	2500	2500 (1844)	–	–	–	–	30.5 (10.4)
	40	2500	2500 (1844)	–	–	–	–	28.2 (9.64)
	50	2500	2500 (1844)	–	–	–	27.9 (9.53)	27.9 (9.53)

¹⁾ The limit values in the table apply for S1 continuous duty (ON time > 60 % or > 20 min) for a maximum gearbox temperature of 90 °C (194 °F).

5.5 Braking resistors (armature short-circuit braking)

For transistor PWM converters, when the DC link voltage values are exceeded or if the electronics fails, then electrical braking is no longer possible. If the drive which is coasting down, can represent a potential hazard, then the motor can be braked by short-circuiting the armature. Armature short-circuit braking should be initiated at the latest by the limit switch in the traversing range of the feed axis.

The friction of the mechanical system and the switching times of the contactors must be taken into account when determining the distance that the feed axis takes to come to a complete stop. In order to avoid mechanical damage, mechanical stops should be located at the end of the absolute traversing range.

For servomotors with integrated holding brake, the holding brake can be simultaneously applied to create an additional braking torque – however, with some delay.

CAUTION

The converter pulses must first be canceled and this actually implemented before an armature short-circuit contactor is closed or opened. This prevents the contactor contacts from burning and eroding and destroying the converter.

 WARNING

The drive must always be operationally braked using the setpoint input. For additional information, refer to the Converter Configuration Manual.
--

The optimum braking torque of the servomotor in regenerative operation can be obtained using armature short-circuit with a matching external resistor circuit.

Possible ordering address: <http://www.frizlen.com>

Note

It goes without saying that equivalent products from other manufacturers may be used. Our recommendations should be considered as such. We cannot accept any liability for the quality and properties/features of third-party products.

Circuit (block diagram)

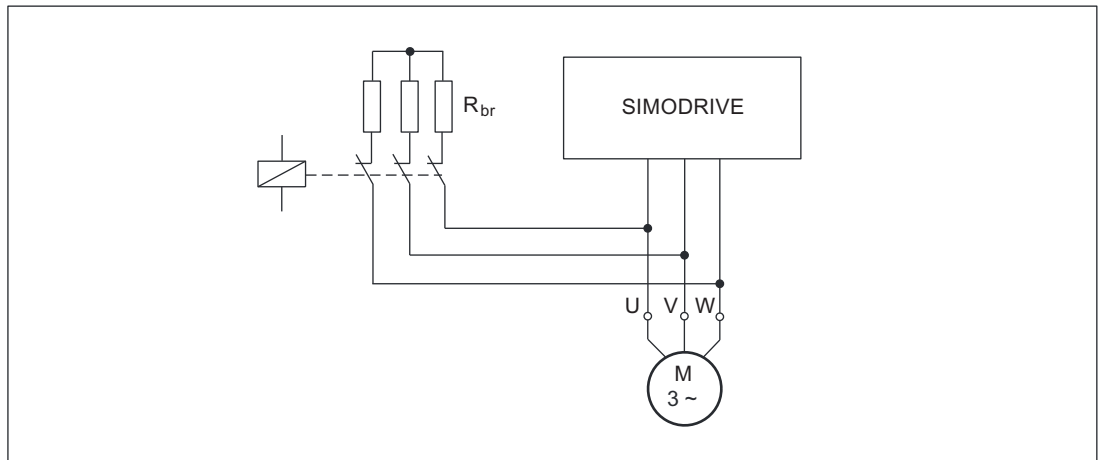

Figure 5-7 Circuit (schematic) with brake resistors

Rating

The ratings of the resistors must match the particular I²t load capability. The resistors can be dimensioned so that a surface temperature of 300° C can occur briefly (max. 500 ms). In order to prevent the resistors from being destroyed, braking from the rated speed can occur max. every 2 minutes. Other braking cycles must be specified when ordering the resistors. The external moment of inertia and the intrinsic motor moment of inertia are decisive when dimensioning these resistors.

The kinetic energy must be specified when ordering in order to determine the resistor rating.

$$W = \frac{1}{2} \cdot J \cdot \omega^2$$

W = Kinetic energy [Ws]

J = Moment of inertia [kgm²]

ω = Angular velocity [s⁻¹]

$$\omega = \frac{2 \cdot \pi}{60} \cdot 2 \cdot n$$

n = speed [rpm]

Calculating the braking time

Braking time:
$$t_B = \frac{J_{tot} \cdot n}{9.55 \cdot M_B}$$

t_B = Braking time [s]

n = operating speed [rpm]

M_B = average braking torque [Nm]

J_{tot} = moment of inertia [kgm²]

Moment of inertia:
$$J_{tot} = J_{mot} + J_{external}$$

J_{mot} = motor moment of inertia [kgm²]

J_{external} = external moment of inertia [kgm²]

NOTICE

When determining the run-on distance, the friction (taken into account as allowance in M_B) of the mechanical transmission elements and the switching delay times of the contactors must be taken into consideration. In order to prevent mechanical damage, mechanical end stops should be provided at the end of the absolute traversing range of the machine axes.

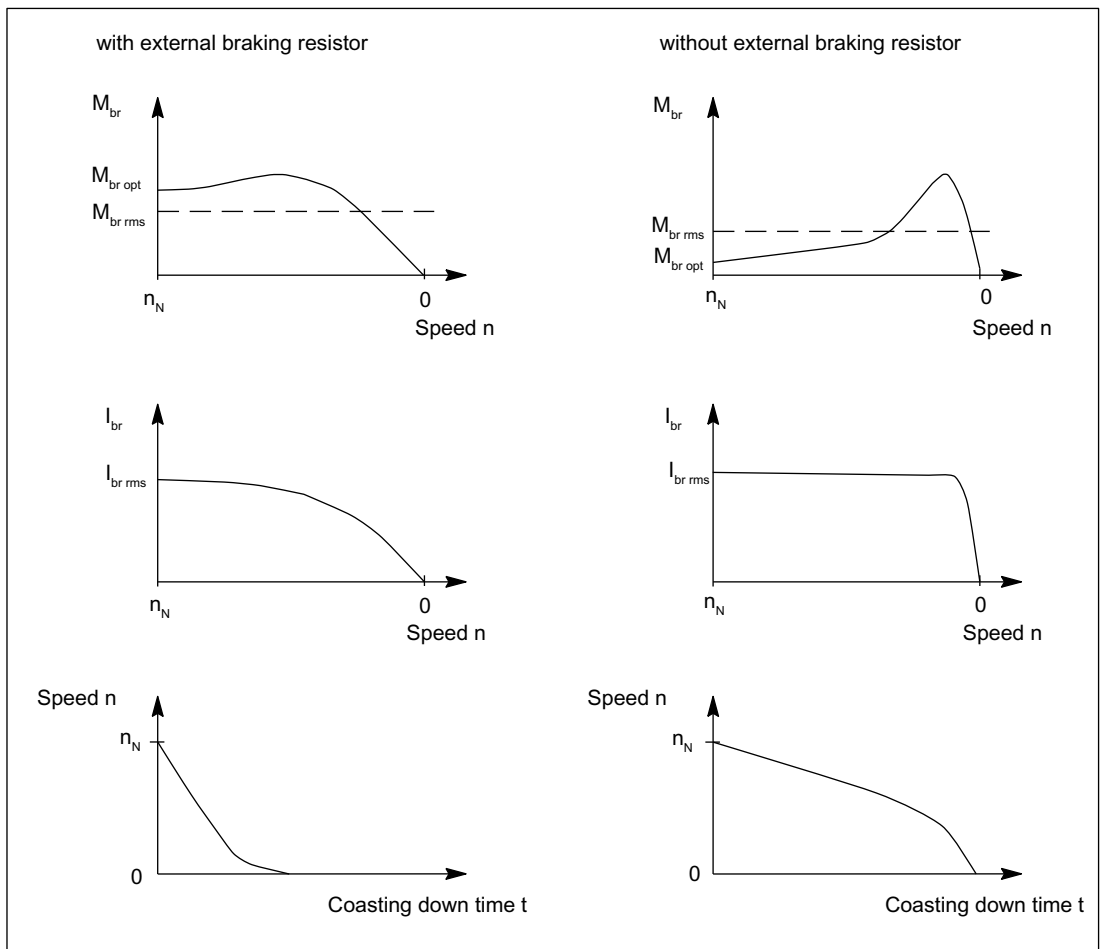

Figure 5-8 Armature short-circuit braking

Dimensioning of braking resistors

The correct dimensioning ensures an optimum braking time. The braking torques which are obtained are also listed in the tables. The data applies for braking from the rated speed and moment of inertia $J_{external} = J_{Mot}$. If the drive is braked from another speed, then the braking time cannot be proportionally reduced. However, longer braking times cannot occur if the speed at the start of braking is less than the rated speed.

The data in the following table is calculated for rated values according to the data sheet. The variance during production as well as iron saturation have not been taken into account here. Higher currents and torques can occur than those calculated as a result of the saturation.

1FT7 Compact, natural cooling

Table 5-7 Armature short-circuit braking with/without external braking resistors

Motor type	External braking resistor R_{opt} [Ω]	Average braking torque $M_{Br\ eff}$ [Nm]		Max. braking torque $M_{Br\ max}$ [Nm]	Effective braking current $I_{Br\ eff}$ [A]	
		Without external braking resistor	With external braking resistor		Without external braking resistor	With external braking resistor
1FT7034-□AK7	6.7	2.0	3.0	3.8	9.2	8.3
1FT7036-□AF7	4.2	3.2	5.0	6.2	15.1	13.7
1FT7042-□AF7	6.6	3.3	4.3	5.4	7.4	6.7
1FT7042-□AK7	5.0	2.5	4.5	5.6	13.8	12.4
1FT7044-□AF7	4.8	7.4	10.0	12.5	13.4	12.2
1FT7044-□AK7	3.3	4.6	9.5	11.8	24.9	22.3
1FT7046-□AF7	3.6	9.7	13.7	17.0	18.3	16.6
1FT7046-□AH7	1.6	8.0	13.7	17.0	35.9	32.3
1FT7062-□AF7	10.4	1.9	4.4	5.4	6.9	6.2
1FT7062-□AK7	5.0	1.2	4.4	5.4	14.6	13.1
1FT7064-□AF7	7.0	3.0	7.3	9.1	11.0	9.9
1FT7064-□AK7	6.1	1.9	7.3	9.1	17.2	15.4
1FT7066-□AF7	3.8	4.3	10.7	13.3	17.9	16.0
1FT7066-□AH7	2.5	2.9	10.2	12.7	27.1	24.2
1FT7068-□AF7	4.5	5.7	14.9	18.5	19.6	17.6
1FT7082-□AC7	9.6	4.0	9.2	11.4	8.5	7.6
1FT7082-□AF7	6.7	3.0	9.2	11.4	12.8	11.5
1FT7082-□AH7	3.9	2.3	9.3	11.5	20.9	18.7
1FT7084-□AC7	3.9	6.8	16.4	20.4	17.9	16.0
1FT7084-□AF7	4.4	4.9	16.5	20.5	21.3	19.1
1FT7084-□AH7	3.2	3.7	16.2	20.1	30.4	27.2
1FT7086-□AC7	4.0	9.1	23.8	29.6	21.5	19.3
1FT7086-□AF7	2.9	7.2	23.8	29.6	31.4	28.1
1FT7086-□AH7	2.2	5.1	23.5	29.2	44.1	39.4
1FT7102-□AB7	4.3	11.5	27.4	34.0	19.0	17.0
1FT7102-□AC7	2.9	9.7	27.3	34.0	27.0	24.2
1FT7102-□AF7	2.3	7.4	27.6	34.3	38.4	34.4
1FT7105-□AB7	2.4	18.1	50.8	63.1	35.1	31.5
1FT7105-□AC7	2.1	14.4	51.1	63.5	44.3	39.7
1FT7105-□AF7	1.7	10.5	49.9	61.9	59.9	53.6
1FT7108-□AB7	2.2	23.9	71.6	89.0	44.4	39.8
1FT7108-□AC7	1.5	20.7	72.5	90.1	62.2	55.7
1FT7108-□AF7	1.3	15.9	70.7	87.9	83.0	74.3

5.5 Braking resistors (armature short-circuit braking)

1FT7 Compact, forced ventilation

Table 5- 8 Armature short-circuit braking with/without external braking resistors

Motor type	External braking resistor R_{opt} [Ω]	Average braking torque $M_{Br\ eff}$ [Nm]		Max. braking torque $M_{Br\ max}$ [Nm]	Effective braking current $I_{Br\ eff}$ [A]	
		Without external braking resistor	With external braking resistor		Without external braking resistor	With external braking resistor
1FT7084-5SC7	2.5	7	18	22	23	21
1FT7084-5SF7	2.0	6	18	22	33	29
1FT7084-5SH7	1.6	4	17	20	44	39
1FT7086-5SC7	2.1	9	24	29	30	27
1FT7086-5SF7	2.2	5	24	29	44	39
1FT7086-5SH7	1.6	5	24	29	53	47
1FT7105-5SC7	1.3	15	50	62	56	50
1FT7105-5SF7	0.9	12	50	62	81	73
1FT7108-5SC7	1.1	19	69	86	70	63
1FT7108-5SF7	0.8	15	71	88	103	92

1FT7 Compact, liquid cooling

Table 5- 9 Armature short-circuit braking with/without external braking resistors

Motor type	External braking resistor R_{opt} [Ω]	Average braking torque $M_{Br\ eff}$ [Nm]		Max. braking torque $M_{Br\ max}$ [Nm]	Effective braking current $I_{Br\ eff}$ [A]	
		Without external braking resistor	With external braking resistor		Without external braking resistor	With external braking resistor
1FT7062-5WF7	5.5	3.2	6.6	8.2	11.5	10.3
1FT7062-5WK7	4.2	2.0	6.6	8.2	19.3	17.3
1FT7064-5WF7	3.3	4.8	10.9	13.6	19.3	17.3
1FT7064-5WK7	2.4	3.2	11.0	13.7	33.2	29.7
1FT7066-5WF7	2.7	6.7	15.3	19.0	25.5	22.9
1FT7066-5WH7	2.1	5.1	15.6	19.4	36.5	32.7
1FT7068-5WF7	2.1	10.6	24.0	29.8	36.1	32.4
1FT7082-5WC7	3.0	8.3	16.0	19.8	19.4	17.5
1FT7082-5WF7	2.2	6.6	16.1	19.9	29.0	26.0
1FT7082-5WH7	1.5	5.0	16.0	19.9	44.2	39.5
1FT7084-5WC7	2.2	12.3	27.0	33.5	30.4	27.2
1FT7084-5WF7	1.8	9.5	26.6	33.1	42.1	37.7
1FT7084-5WH7	1.2	7.3	26.6	33.1	62.4	55.9
1FT7086-5WC7	1.6	16.7	37.7	46.9	41.6	37.3
1FT7086-5WF7	1.2	13.0	38.0	47.2	62.0	55.5
1FT7086-5WH7	1.3	10.2	37.8	47.0	73.8	66.0

Motor type	External braking resistor R_{opt} [Ω]	Average braking torque $M_{Br\ eff}$ [Nm]		Max. braking torque $M_{Br\ max}$ [Nm]	Effective braking current $I_{Br\ eff}$ [A]	
		Without external braking resistor	With external braking resistor		Without external braking resistor	With external braking resistor
1FT7102-5WB7	1.8	21.1	44.1	54.8	36.9	33.1
1FT7102-5WC7	1.2	17.6	43.9	54.6	53.1	47.6
1FT7102-5WF7	0.7	13.6	44.2	54.9	85.0	76.1
1FT7105-5WB7	1.1	39.0	89.6	111	67.9	60.8
1FT7105-5WC7	0.8	32.3	89.3	111	93.8	83.9
1FT7105-5WF7	0.7	25.6	89.1	111	127	114
1FT7108-5WB7	0.8	54.0	127	158	95.3	85.4
1FT7108-5WC7	0.8	45.0	128	159	112	100
1FT7108-5WF7	0.6	36.1	128	159	163	145

1FT7 High Dynamic, forced ventilation

Table 5- 10 Armature short-circuit braking with/without external braking resistors

Motor type	External braking resistor R_{opt} [Ω]	Average braking torque $M_{Br\ eff}$ [Nm]		Max. braking torque $M_{Br\ max}$ [Nm]	Effective braking current $I_{Br\ eff}$ [A]	
		Without external braking resistor	With external braking resistor		Without external braking resistor	With external braking resistor
1FT7065-7SF7	3.4	3.5	8	10	17	15
1FT7065-7SH7	2.9	2.5	8	10	23	21
1FT7067-7SF7	2.4	4.5	11	14	24	21
1FT7067-7SH7	2.3	3.5	11	14	30	27
1FT7085-7SF7	1.8	4.5	18	22	34	31
1FT7085-7SH7	1.5	3.5	17	22	47	42
1FT7087-7SF7	1.2	7.0	26	32	51	45
1FT7087-7SH7	1.5	5.0	25	31	55	49

1FT7 High Dynamic, liquid cooling

Table 5- 11 Armature short-circuit braking with/without external braking resistors

Motor type	External braking resistor R_{opt} [Ω]	Average braking torque $M_{Br\ eff}$ [Nm]		Max. braking torque $M_{Br\ max}$ [Nm]	Effective braking current $I_{Br\ eff}$ [A]	
		Without external braking resistor	With external braking resistor		Without external braking resistor	With external braking resistor
1FT7065-7WF7	3.4	3.5	8	10	17	15
1FT7065-7WH7	2.9	2.5	8	10	23	21
1FT7067-7WF7	2.4	4.5	11	14	24	21

5.5 Braking resistors (armature short-circuit braking)

Motor type	External braking resistor R_{opt} [Ω]	Average braking torque $M_{Br\ eff}$ [Nm]		Max. braking torque $M_{Br\ max}$ [Nm]	Effective braking current $I_{Br\ eff}$ [A]	
		Without external braking resistor	With external braking resistor		Without external braking resistor	With external braking resistor
1FT7067-7WH7	2.3	3.5	11	14	30	27
1FT7085-7WF7	1.8	4.5	18	22	34	31
1FT7085-7WH7	1.1	3.5	17	21	55	49
1FT7087-7WF7	1.2	7.0	26	32	51	45
1FT7087-7WH7	1.1	5.0	26	32	67	60

Cables and connections

6

6.1 Power connection

⚠ WARNING

The motors are not designed to be connected directly to the line supply.

Connection assignment, power connector at the motor

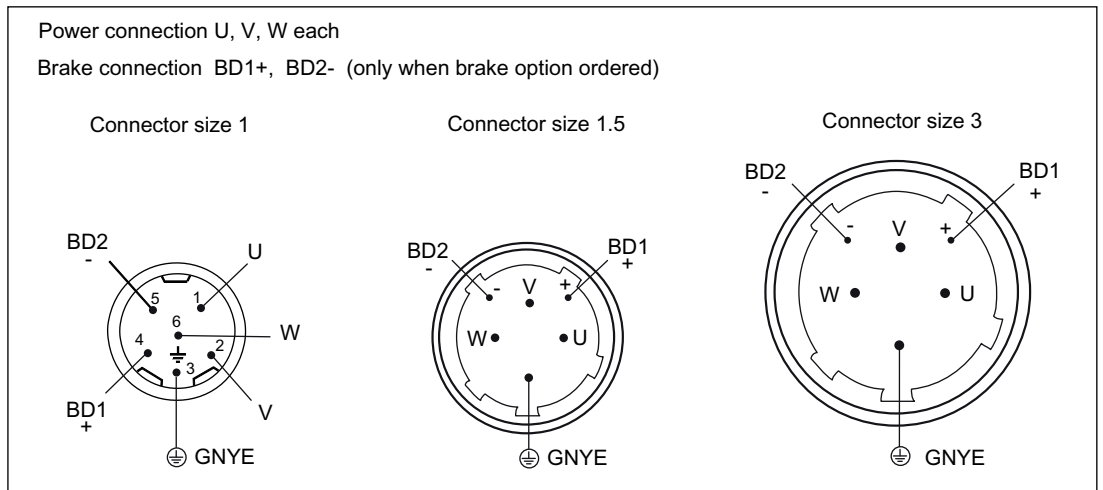

Figure 6-1 Power connection

Power connection via terminal box

- The terminal assignment in the terminal box must be implemented according to the diagram.
- The PE conductor must be connected.

6.1 Power connection

- Cable lugs must be used in accordance with DIN 46234.
- Connect optional brake (see figure).

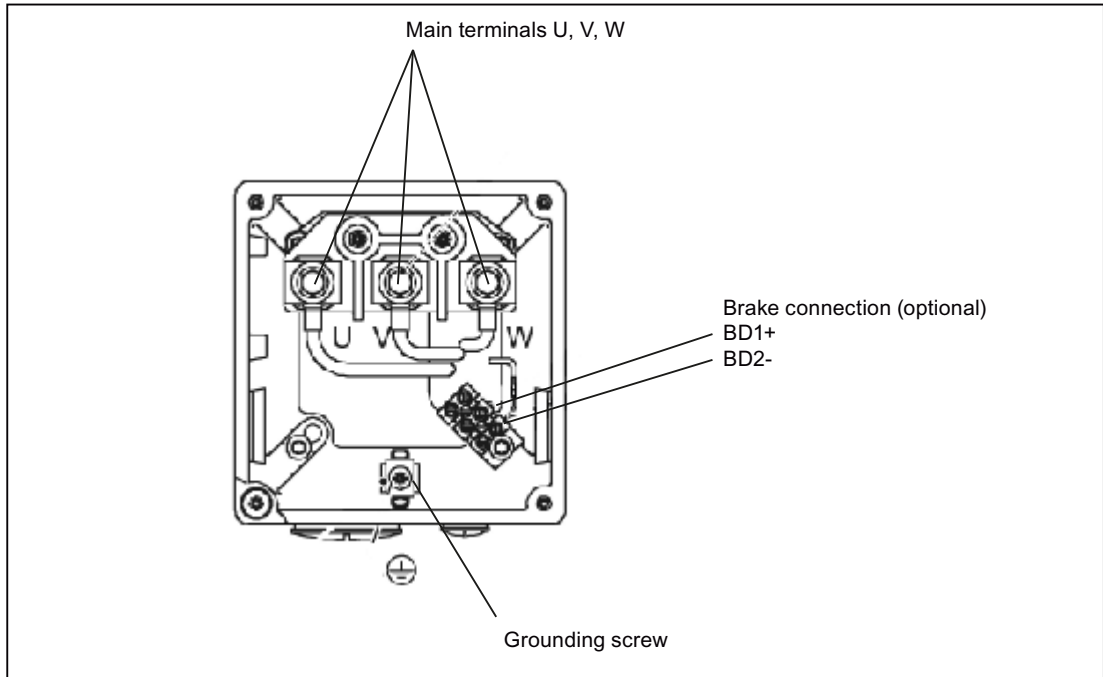

Figure 6-2 Terminal box gk230

Table 6- 1 Connections for terminal box

Terminal box type	gk230
Cable entry	1 x PG 29 / 1 x PG 9
Max. outer cable diameter ¹⁾	30 mm
RMS current per terminal ²⁾	66 A
Nuber of main terminals U, V, W	3 x M5
Max. cross-section per terminal	1 x 16 mm ²
Ground connection	M4
Tightening torque [Nm]	0.8 - 1.2
Brake connection ³⁾	1.5 mm ²

1) Dependent on the seal used

2) Data according to DIN EN 60204-1 (routing type C, ambient temperature 40 °C)

3) BD1+/BD2- (terminal strip, only for versions with brake)

Connecting-up information

⚠ WARNING

Before carrying out any work on the AC motor, please ensure that it is powered-down and the system is locked-out so that the motor cannot re-start!

Please observe the data on the rating plate (type plate) and the circuit diagram in the terminal box.

Note

The overall system compatibility is only guaranteed when using shielded power cables.

Shields must be incorporated in the protective grounding concept. Protective ground should be connected to conductors that are open-circuit and that are not being used and also electrical cables that can be touched. If the brake feeder cables in the SIEMENS cable accessories are not used, then the brake conductor cores and shields must be connected to the cabinet ground (open-circuit cables result in capacitive charges!).

- Twisted or three-core cables with additional ground conductor should be used as motor feeder cables. The insulation should be removed from the ends of the conductors so that the remaining insulation extends up to the cable lug or terminal.
- The connecting cables should be freely arranged in the terminal box so that the protective conductor has an overlength and the cable conductor insulation cannot be damaged. Connecting cables should be appropriately strain relieved.
- Please ensure that the following minimum air distances are maintained: Supply voltages up to 500 V: Minimum air distance 4.5 mm
- After connecting up, the following should be checked:
 - The inside of the terminal box must be clean and free of any cable pieces
 - All of the terminal screws must be tight
 - The minimum air distances must be maintained
 - The cable glands must be reliably sealed
 - Unused cable glands must be closed and the plugs must be tightly screwed in place
 - All of the sealing surfaces must be in a perfect condition

Current-carrying capacity for power and signal cables

The current-carrying capacity of PVC/PUR-insulated copper cables is specified for routing types B1, B2 and C under continuous operating conditions in the table with reference to an ambient air temperature of 40 °C. For other ambient temperatures, the values must be corrected by the factors from the "Derating factors" table.

Table 6-2 Cable cross section and current-carrying capacity

Cross section [mm ²]	Current-carrying capacity rms; AC 50/60 Hz or DC for routing type		
	B1 [A]	B2 [A]	C [A]
Electronics (according to EN 60204-1)			
0,20	-	4,3	4,4
0,50	-	7,5	7,5
0,75	-	9	9,5
Power (according to EN 60204-1)			
0,75	8,6	8,5	9,8
1,00	10,3	10,1	11,7
1,50	13,5	13,1	15,2
2,50	18,3	17,4	21
4	24	23	28
6	31	30	36
10	44	40	50
16	59	54	66
25	77	70	84
35	96	86	104
50	117	103	125
70	149	130	160
95	180	165	194
120	208	179	225
Power (according to IEC 60364-5-52)			
150	-	-	259 ¹⁾
185	-	-	296 ¹⁾
> 185	Values must be taken from the standard		

¹⁾ Extrapolated values

Table 6-3 Derating factors for power and signal cables

Ambient air temperature [°C]	Derating factor according to EN 60204-1 Table D1
30	1,15
35	1,08
40	1,00
45	0,91
50	0,82
55	0,71
60	0,58

6.2 Signal connection

Pin assignment for 17-pin angle plug with pin contacts

Table 6- 4 Connection assignment, 17-pin flange-mounted socket

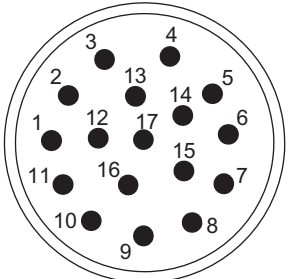
PIN no.	IC2048S/R incremental encoder	AM2048S/R absolute encoder	
1	A	A	 <p>When viewing the plug-in side (pins)</p>
2	A*	A*	
3	R	data	
4	D*	not connected	
5	C	clock	
6	C*	not connected	
7	M encoder, 0 V	M encoder, 0 V	
8	+1R1 (KTY)	+1R1 (KTY)	
9	-1R2 (KTY)	-1R2 (KTY)	
10	P encoder, +5 V	P encoder, +5 V	
11	B	B	
12	B*	B*	
13	R*	data*	
14	D	clock*	
15	0 V sense	0 V sense	
16	5 V sense	5 V sense	
17	not connected	not connected	

Cables

In order to avoid interference/noise (e.g. due to EMC), and guarantee protective separation, the power cables and signal cables must be separately routed.

Prefabricated cables from Siemens (MOTION-CONNECT) should be used. When compared to cables fabricated by customers, these offer advantages regarding functional safety, quality and costs.

Table 6- 5 Prefabricated cable for incremental encoder

6FX	□	002	-	2CA31	-	□□□	0
	↓	5 MOTION-CONNECT®500 8 MOTION-CONNECT®800				↓↓↓	Length, max. cable length 50 m

6.3 Connecting the separately-driven fan

Table 6- 6 Prefabricated cable for absolute encoder

6FX	□	002	-	2EQ10	-	□□□	0
	↓ 5 MOTION-CONNECT®500 8 MOTION-CONNECT®800			↓↓↓ Length, max. cable length 50 m			

For other technical data and length code, refer to Catalog, Chapter "MOTION-CONNECT connection system"

6.3 Connecting the separately-driven fan

Table 6- 7 Supply data for separately-driven fans

Shaft height	Max. current consumption at:	
	1-ph. 230 V AC, 50 Hz (±10%)	1-ph. 230 V AC, 60 Hz (+5%/-10%)
63	< 0.1 A	< 0.1 A
80 to 100	0.40 A	0.45 A

Note the following information regarding connections:

- Only use cables that comply with the relevant installation regulations regarding voltage, current, insulation material, and load-carrying capacity.
- Before connecting the device, make sure that the line voltage matches the device voltage.
- Check whether the data on the fan rating plate matches the connection data.
- Connection cables must not be subject to excessive tensile stress.

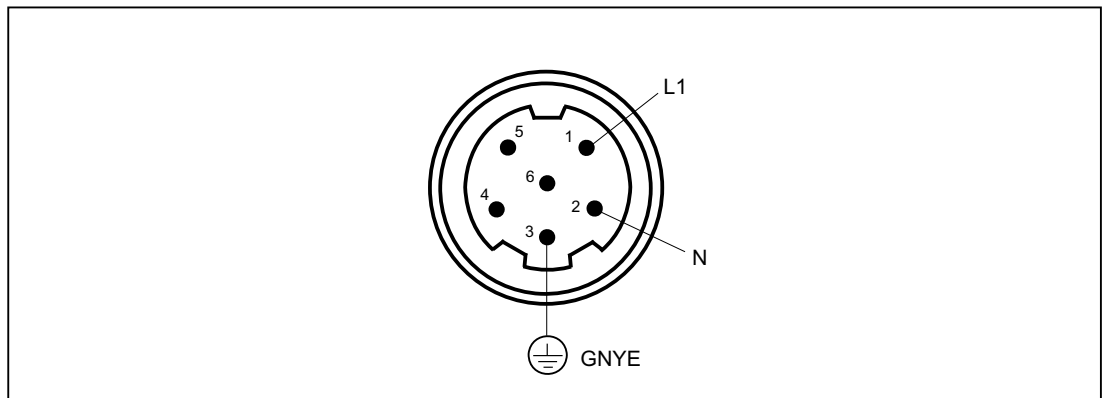

Figure 6-3 Connecting the separately-driven fan by means of the connector

Table 6- 8 Order numbers

	Order number (MLFB)
Plug connection size 1	6FX2003-0CA10
Pre-assembled cable	6FX5002-5CA01-□□□0

6.4 Quick-release lock

The 1FT7 motors can be connected via a quick-release lock (SPEED-CONNECT). The motor connectors are designed in such a way that both the new quick-release lock cables and the conventional cables with screw-type connection can be used.

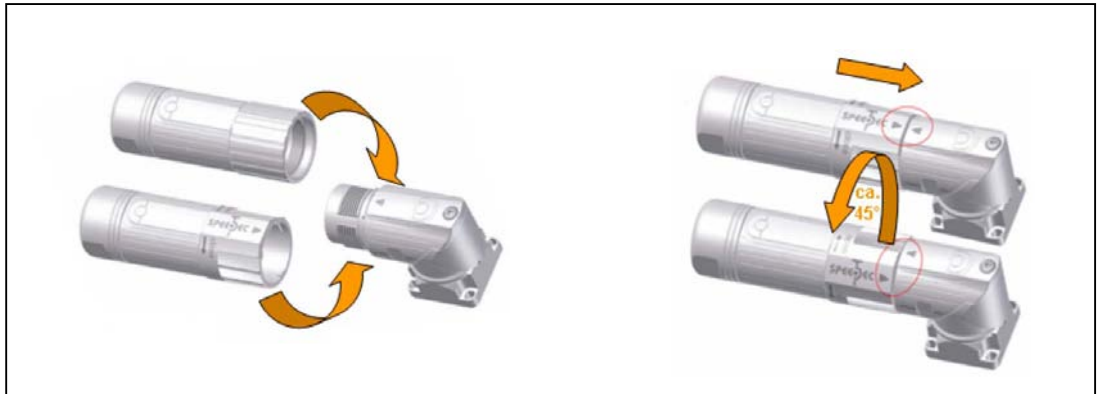

Figure 6-4 Quick-release lock

6.5 Rotating the connector at the motor

Power connectors and signal connectors can be rotated to a limited extent. A suitable socket connector can be used to rotate the angle plug. Make sure that the socket connector is completely secure to avoid damaging the pin contacts.

NOTICE

- It is not permissible that the specified rotation range is exceeded.
- In order to guarantee the degree of protection, max. 10 revolutions are permissible.
- Connectors should be rotated using the matching mating connector located on the connector thread.

6.6 Routing cables in a wet/moist environment

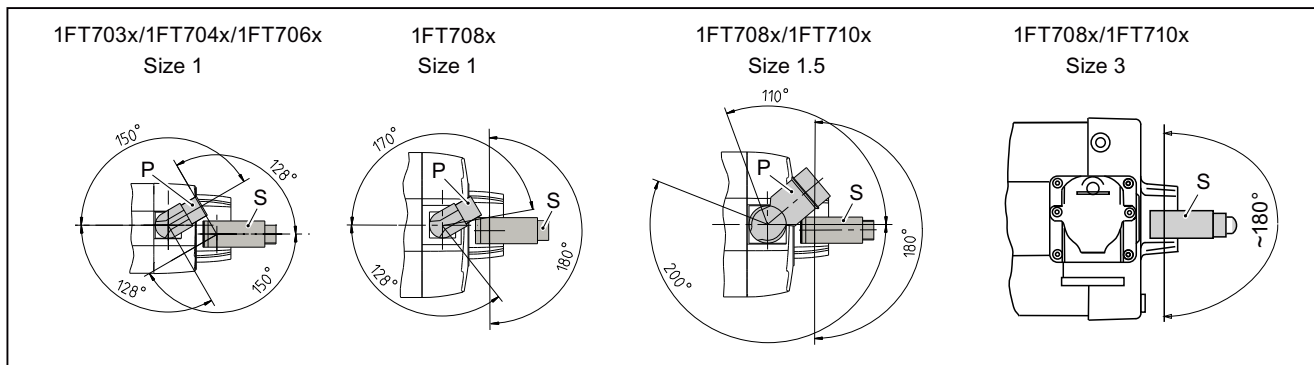

Figure 6-5 Ability to rotate the connectors (P = power connector, S = signal connector)

Table 6-9 Maximum rotating torques that occur

Connector	M _{max}
Power connector, size 1	12 Nm
Power connector, size 1.5	20 Nm
Signal connector	12 Nm

The size 3 power connector cannot be rotated.

NOTICE

Cable outlet direction

If the direction of the cable outlet is not changed correctly, this can damage the connecting cables. The direction of the cable outlet must not be changed since this renders all warranty claims invalid.

6.6 Routing cables in a wet/moist environment

NOTICE

If the motor is mounted in a humid environment, the power and signal cables must be routed as shown in the following figure.

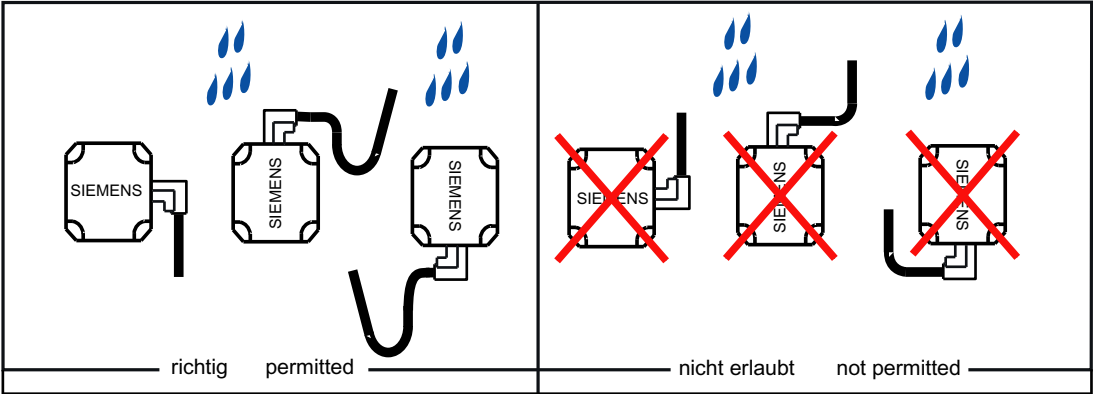

Figure 6-6 Principle cable routing in a moist environment

Information on the application of motors

7.1 Transport / storage before use

During transport and if the motors are out of operation for a long period of time, the cooling circuit must be completely drained to protect against frost damage and corrosion.

The motors should be stored indoors in dry conditions with low-dust and low vibration levels ($v_{\text{eff}} < 0.2$ mm/s). The motors should not be stored longer than two years at room temperature (+5° C to +40° C) to retain the service life of the grease.

Observe the additional notes regarding transport and storage in the operating instructions.

7.2 Environmental conditions

Operating temperature range: -15° C to +40° C (without any restrictions).

All of the catalog data refer to an ambient temperature of 40° C, mounted so that the motors are not thermally insulated and an installation altitude up to 1000 m above sea level.

Under conditions other than those specified above (ambient temperature > 40° C or installation altitude > 1000 m above sea level), the permissible torque/power must be determined using the factors from the following table.

Ambient temperatures and installation altitudes are rounded-off to 5° C or 500 m respectively.

Table 7- 1 Factors to reduce the torque/power (de-rating)

Installation altitude above sea level [m]	Ambient temperature in ° C				
	< 30	30 - 40	45	50	55
1000	1,07	1,00	0,96	0,92	0,87
1500	1,04	0,97	0,93	0,89	0,84
2000	1,00	0,94	0,90	0,86	0,82
2500	0,96	0,90	0,86	0,83	0,78
3000	0,92	0,86	0,82	0,79	0,75
3500	0,88	0,82	0,79	0,75	0,71
4000	0,82	0,77	0,74	0,71	0,67

7.3 Construction types

Table 7- 2 Designation of the types of construction acc. to IEC 60034-7

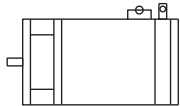
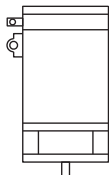
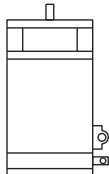
Designation	Representation	Description
IM B5		Standard
IM V1		Note: When configuring the IM V1 and IM V3 type of construction, attention must be paid to the permissible axial forces (weight force of the drive elements) and especially to the necessary degree of protection. For IM V3 preferably flange form 0 1FT7□□□-□□□□0-□□□□
IM V3		Attention must be paid to suitable coverage of the motor shaft (splash water).

7.4 Mounting conditions

Some of the motor power loss is dissipated through the flange when the motor is connected to the mounting flange.

Non-thermally insulated mounting

The following mounting conditions apply for the specified motor data:

Table 7- 3 Non-thermally insulated mounting conditions

Shaft height	Steel plate, width x height x thickness [mm]	Mounting surface[m ²]
36 and 48	120 x 100 x 40	0.012
63 to 100	450 x 370 x 30	0.17

For larger mounting surfaces, the heat dissipation conditions improve.

Thermally insulated mounting without additionally mounted components

For non-ventilated and force-ventilated motors, the static motor torque must be reduced by between 5% and 15%. We recommend configuring the motor using the $M_{0(60K)}$ values. As the speed increases, the reduction factor rises (see Fig. "Effect of the mounting conditions on the S1 characteristic").

Thermally insulated mounting with additionally mounted components

- Holding brake (integrated in the motor). No additional torque reduction required
- Gearbox; the torque has to be reduced (see Fig. "Effect of the mounting conditions on the S1 characteristics")

Effect of thermally insulated/non-insulated mounting without and with gearbox

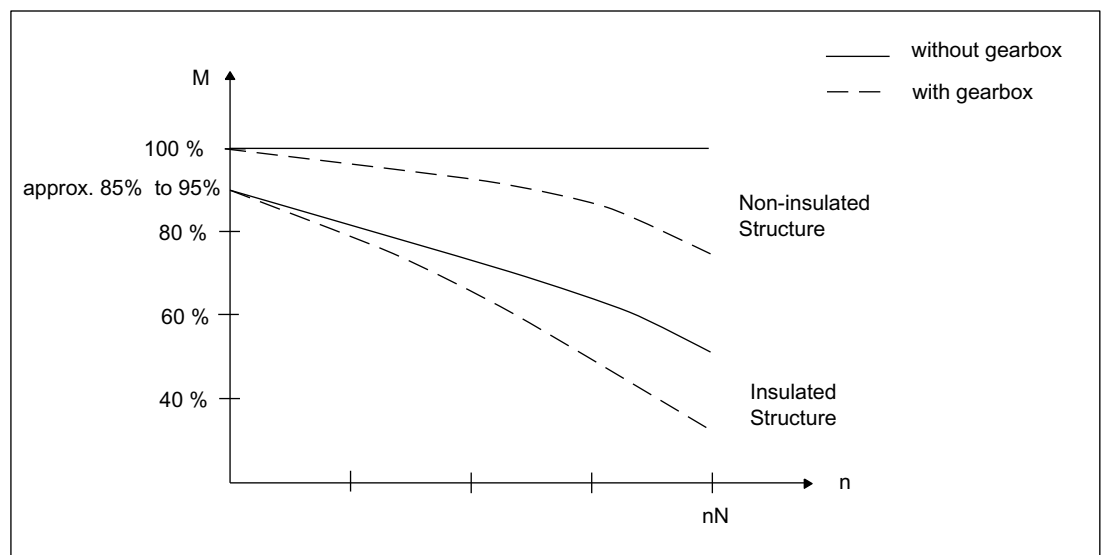

Figure 7-1 Effect of the mounting conditions on the S1 characteristic

7.5 Operation under vibrational or shock stress conditions

In order to ensure problem-free operation and a long service life, the vibration values defined in DIN ISO 10816 should not be exceeded.

Table 7- 4 Vibration values

Vibrational velocity V_{rms} [mm/s] acc. to DIN ISO 10816	Frequency f [Hz]	Acceleration a [m/s ²]
4,5	10	0,4
4,5	250	10

Deviating from the specified standard, motors 1FT703□ to 1FT710□ may be operated with higher loads, with the restriction that the service life will be reduced. In this case, only operation outside the mounted natural frequency is permissible.

7.6 Drive coupling

Peak acceleration	Axial 20 m/s ²	Radial 50 m/s ²
Shock duration	3 ms	3 ms

7.6 Drive coupling

Function description

In order to achieve optimum drive-out characteristics, ROTEX® GS couplings supplied by KTR should be used. The advantages of ROTEX® GS couplings include:

- 2 to 4x torsional stiffness of a belt-driven gearbox
- No intermeshing teeth (when compared to belt gearboxes)
- Low moment of inertia
- Good control behavior

They must be optimally harmonized with existing machine masses, the mounted mechanical system, the machine stiffness, etc.

KTR provides assistance in the selection of the coupling, refer to <http://www.ktr.com>

7.7 Permissible line system configurations

In combination with the drive system, the motors are generally approved for operation on TN and TT systems with **grounded neutral** and on IT systems.

In operation on IT systems, the occurrence of a first fault between an active part and ground must be signaled by a monitoring device. In accordance with IEC 60364-4-41 it is recommended that the first fault should be eliminated as quickly as practically possible.

In systems with a **grounded external conductor**, an isolating transformer with grounded neutral (secondary side) must be connected between the line supply and the drive system to protect the motor insulation from excessive stress. The majority of TT systems have a grounded external conductor, so in this case an isolating transformer must be used.

Appendix

A.1 Description of terms

Rated torque M_N

Thermally permissible continuous torque in S1 duty at the rated motor speed.

Rated speed n_N

The characteristic speed range for the motor is defined in the speed-torque diagram by the rated speed.

Rated current I_N

RMS motor phase current for generating the particular rated torque. Specification of the RMS value of a sinusoidal current.

Rated converter current $I_{N\text{ conv}}$

RMS converter output current (per phase) that can be supplied on a continuing basis by the recommended motor module. The recommended motor module is selected such that $I_{N\text{ conv}}$ is greater than the stall current I_0 (100K).

Braking torque $M_{\text{br eff}}$

$M_{\text{br eff}}$ corresponds to the average braking torque for armature short-circuit braking that is achieved through the upstream braking resistor R_{opt} .

Braking resistance R_{opt}

R_{opt} corresponds to the optimum resistance value per phase that is switched in series external to the motor winding for the armature short-circuit braking function.

DE

Drive end = Drive end of the motor

Cyclic inductance L_D

The cyclic inductance is the sum of the air gap inductance and leakage inductance relative to the single-strand equivalent circuit diagram. It consists of the self-inductance of a phase and the coupled inductance to other phases.

Torque constant k_T (value for a 100 K average winding temperature rise)

Quotient obtained from the static torque and stall current.

Calculation: $k_T = M_{0, 100\text{ K}} / I_{0, 100\text{ K}}$

The constant applies up to approx. $2 \cdot M_{0, 60\text{ K}}$ in the case of self-cooled motors

Note

This constant is not applicable when configuring the necessary rated and acceleration currents (motor losses!).

The steady-state load and the frictional torques must also be included in the calculation.

Electrical time constant T_{el}

Quotient obtained from the rotating field inductance and winding resistance. $T_{el} = L_D / R_{Str}$

Maximum speed n_{max}

The maximum mechanically permissible operating speed n_{max} is the lesser of the maximum mechanically permissible speed and the maximum permissible speed at the converter.

Maximum torque M_{max}

Torque that is generated at the maximum permissible current. The maximum torque is briefly available for high-speed operations (dynamic response to quickly changing loads).

The maximum torque is limited by the closed-loop control parameters. If the current is increased, then the rotor will be de-magnetized.

Maximum torque (limited by converter) $M_{max\ conv}$

The maximum torque that can be applied (temporarily) for operation on the recommended motor module.

Max. current $I_{max, RMS}$

This current limit is only determined by the magnetic circuit. Even if this is briefly exceeded, it can result in an irreversible de-magnetization of the magnetic material. Specification of the RMS value of a sinusoidal current.

Maximum converter current $I_{max\ conv}$

RMS converter output current (per phase) that can be supplied temporarily by the recommended motor module

Maximum permissible speed (mechanical) n_{\max} .

The maximum mechanically permissible speed is $n_{\max \text{ mech}}$. It is defined by the centrifugal forces and frictional forces in the bearing.

Maximum permissible speed at converter $n_{\max \text{ conv}}$

The maximum permissible operating speed for operation at a converter is $n_{\max \text{ conv}}$ (e.g. limited by withstand voltage, maximum frequency).

Mechanical time constant T_{mech}

The mechanical time constant is obtained from the tangent at a theoretical ramp-up function through the origin.

$$T_{\text{mech}} = 3 \cdot R_{\text{Str}} \cdot J_{\text{Mot}} / k_{\text{T}}^2 \text{ [s]}$$

J_{Mot} = Servomotor moment of inertia [kgm²]

R_{Str} = Phase resistance of the stator winding [Ohm]

k_{T} = Torque constant [Nm/A]

NDE

Non-drive end = Non-drive end of the motor

Optimum operating point

Operating point at which the maximum continuous output of the motor is normally provided at high efficiency (see figure below).

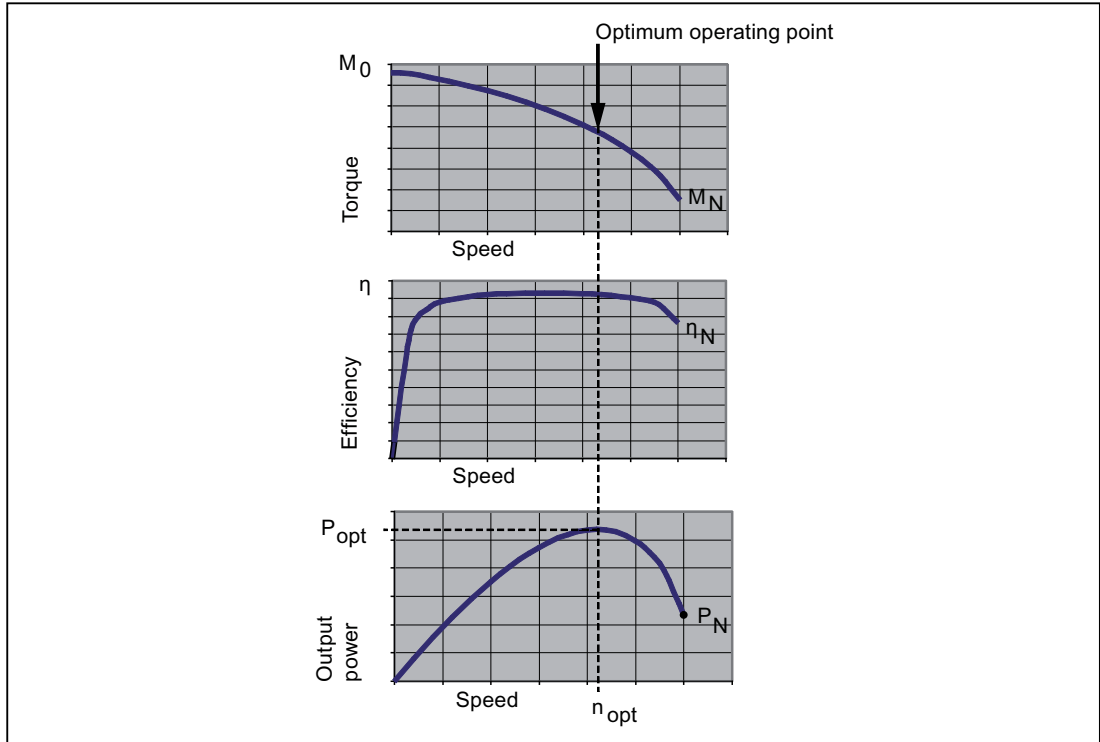

Figure A-1 Optimum operating point

Optimum speed n_{opt}

Speed at which the optimum motor power is output.

If the rated speed is less than the optimum speed, the rated speed is output.

Optimum power P_{opt}

Power achieved at the optimum speed.

The rated speed is the optimum speed (see optimum speed), the optimum power corresponds to the rated power.

Number of poles $2p$

Number of magnetic north and south poles on the rotor. p is the number of pole pairs.

Voltage constant k_E (value at 20° C rotor temperature)

Rms value of the induced motor voltage at a speed of 1000 rpm and a rotor temperature of 20 °C.

Static torque M_0

Thermal limit torque at motor standstill corresponding to a utilization according to 100 K or 60 K. This can be output for an unlimited time when $n = 0$. M_0 is always greater than the rated torque M_N .

Stall current I_0

Motor phase current for generating the particular static torque. Specification of the RMS value of a sinusoidal current.

Thermal time constant T_{th}

Defines the increase in the motor frame temperature when the motor load is suddenly increased (step function) to the permissible S1 torque. The motor has reached 63% of its final temperature after T_{th} .

Moment of inertia J_{mot}

Moment of inertia of rotating motor parts.

Shaft torsional stiffness c_T

This specifies the shaft torsional stiffness from the center of the rotor laminated core to the center of the shaft end.

Winding resistance R_{str} at 20 °C winding temperature

The resistance of a phase at a winding temperature of 20° C is specified. The winding has a star circuit configuration.

A.2 References

Overview of publications of planning manuals

An updated overview of publications is available in a number of languages on the Internet at: www.siemens.com/motioncontrol
Select "Support" → "Technical Documentation" → "Ordering Documentation" → "Printed Documentation".

Catalogs

Order code	Catalog name
NC 61	SINUMERIK & SINAMICS
NC 60	SINUMERIK & SIMODRIVE

PM 21 SIMOTION & SINAMICS

Electronic Documentation

Order code	DOC ON CD
CD1	The SINUMERIK System (includes all SINUMERIK 840D/810D and SIMODRIVE 611D)
CD2	The SINAMICS System

A.3 Suggestions/corrections

Should you come across any printing errors when reading this publication, please notify us on this sheet. We would also be grateful for any suggestions and recommendations for improvement.

To: SIEMENS AG I DT MC MS1 P.O. Box 3180 D-91050 Erlangen, Federal Republic of Germany Fax: +49 (0) 9131 / 98 - 2176 (documentation) mailto:docu.motioncontrol@siemens.com http://www.siemens.com/automation/service&support	From Name:
	Address of your Company/Dept.
	Street:
	Postal code: Location:
	Phone: /
	Fax: /

Suggestions and/or corrections

A.4 Siemens Service Center

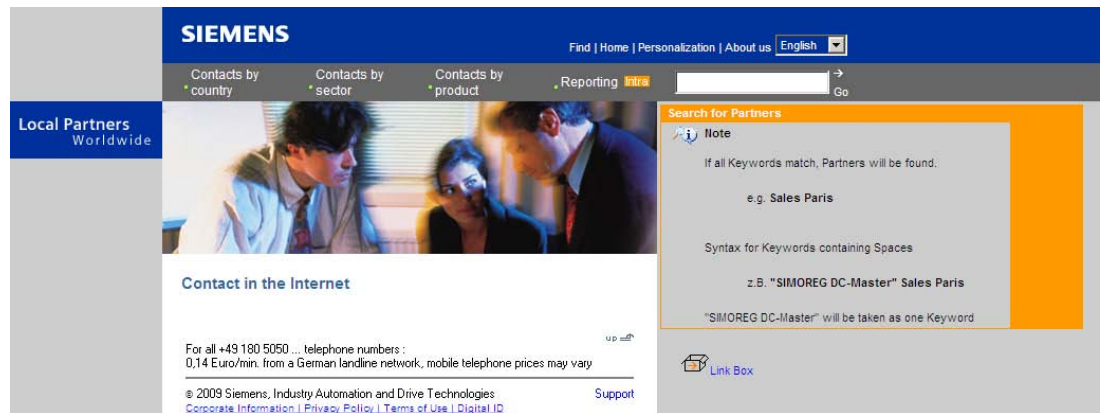

At

<http://www.siemens.com/automation/partner>

you can find Siemens contacts worldwide for information about specific technologies.

Wherever possible, you will find a local contact partner for:

- Technical support,
- Spare parts/repairs,
- Service,
- Training,
- Sales or
- Technical support/engineering.

You start by selecting

- a country,
- a product or
- a sector.

Once the remaining criteria have been laid down, the required contact will be shown along with the associated area of expertise.

Index

A

Absolute encoder, 265
Armature short-circuit braking, 278
Axial eccentricity, 68
Axial force, 67

B

Belt pre-tension, 64
Brake resistors, 278

C

Cables and connections, 285
Concentricity, 68
Coupling outputs, 298

D

Danger and warning information, 6
Degree of protection, 62
Disposal, 9

E

Encoders, 263
Engineering, 41
Environmental compatibility, 9
Environmental conditions, 295
ESDS instructions, 8

F

Forced ventilation, 49

G

Gearbox, 270

H

Holding brake, 266

I

Incremental encoders, 263

M

Mounting conditions, 296
Mounting positions, 296

N

Natural cooling, 49
NCSD Configurator, 39

P

Planetary gearbox, 272

R

Radial force, 64

S

Sealing of the motor shaft, 63
Shaft end, 69
Shock stressing, 297
Siemens Service Center, 305
SinuCom, 39
Smooth running, 68
Sound pressure level, 71

T

Technical data
1FT7034-□AK7, 84
1FT7036-□AK7, 86
1FT7042-□AF7, 88
1FT7042-□AK7, 90
1FT7044-□AF7, 92
1FT7044-□AK7, 94
1FT7046-□AF7, 96
1FT7046-□AH7, 98
1FT7062-5WF7, 166

1FT7062-5WK7, 168
1FT7062-□AF7, 100
1FT7062-□AK7, 102
1FT7064-5WF7, 170
1FT7064-5WK7, 172
1FT7064-□AF7, 104
1FT7064-□AK7, 106
1FT7065-7SF7, 216
1FT7065-7SH7, 218
1FT7065-7WF7, 232
1FT7065-7WH7, 234
1FT7066-5WF7, 174
1FT7066-5WH7, 176
1FT7066-□AF7, 108
1FT7066-□AH7, 110
1FT7067-7SF7, 220
1FT7067-7SH7, 222
1FT7067-7WF7, 236
1FT7067-7WH7, 238
1FT7068-5WF7, 178
1FT7068-□AF7, 112
1FT7082-5WC7, 180
1FT7082-5WF7, 182
1FT7082-5WH7, 184
1FT7082-□AC7, 114
1FT7082-□AF7, 116
1FT7082-□AH7, 118
1FT7084-5SC7, 150
1FT7084-5SF7, 152
1FT7084-5SH7, 154
1FT7084-5WC7, 186
1FT7084-5WF7, 188
1FT7084-5WH7, 190
1FT7084-□AC7, 120
1FT7084-□AF7, 122
1FT7084-□AH7, 124
1FT7085-7SF7, 224
1FT7085-7SH7, 225
1FT7085-7WF7, 240
1FT7085-7WH7, 242
1FT7086-5SC7, 155
1FT7086-5SF7, 158
1FT7086-5SH7, 160
1FT7086-5WC7, 192
1FT7086-5WF7, 194
1FT7086-5WH7, 196
1FT7086-□AC7, 126
1FT7086-□AF7, 128
1FT7086-□AH7, 130
1FT7087-7SF7, 228
1FT7087-7SH7, 230
1FT7087-7WF7, 244

1FT7087-7WH7, 246
1FT7102-5WB7, 198
1FT7102-5WC7, 200
1FT7102-5WF7, 202
1FT7102-□AB7, 132
1FT7102-□AC7, 134
1FT7102-□AF7, 136
1FT7105-5SC7, 162
1FT7105-5SF7, 164
1FT7105-5WB7, 204
1FT7105-5WC7, 206
1FT7105-5WF7, 208
1FT7105-□AB7, 138
1FT7105-□AC7, 140
1FT7105-□AF7, 142
1FT7108-5WB7, 210
1FT7108-5WC7, 212
1FT7108-5WF7, 214
1FT7108-□AB7, 144
1FT7108-□AC7, 146
1FT7108-□AF7, 148

Technical features, 19
Thermal motor protection, 261
Third-party products, 9
Types of construction, 296

V

Vibration operation, 297

W

Water cooling, 50

Siemens AG
Industry Sector
Drive Technologies
Motion Control Systems
P.O. Box 3180
91050 ERLANGEN
GERMANY

www.siemens.com/motioncontrol

Subject to change without prior notice
© Siemens AG 2010